

# R&S®FSW-K91

## WLAN Measurements

### User Manual



1173.9357.02 – 03

This manual applies to the following R&S®FSW models with firmware version 1.51 and higher:

- R&S®FSW8 (1312.8000K08)
- R&S®FSW13 (1312.8000K13)
- R&S®FSW26 (1312.8000K26)

The following firmware options are described:

- R&S FSW-K91 WLAN 802.11a (1313.1500.02)
- R&S FSW-K91ac WLAN 802.11ac (1313.4209.02)
- R&S FSW-K91n WLAN 802.11n (1313.1516.02)

The firmware of the instrument makes use of several valuable open source software packages. For information, see the "Open Source Acknowledgement" on the user documentation CD-ROM (included in delivery).

Rohde & Schwarz would like to thank the open source community for their valuable contribution to embedded computing.

© 2012 Rohde & Schwarz GmbH & Co. KG

Muehldorfstr. 15, 81671 Munich, Germany

Phone: +49 89 41 29 - 0

Fax: +49 89 41 29 12 164

E-mail: [info@rohde-schwarz.com](mailto:info@rohde-schwarz.com)

Internet: <http://www.rohde-schwarz.com>

Printed in Germany – Subject to change – Data without tolerance limits is not binding.

R&S® is a registered trademark of Rohde & Schwarz GmbH & Co. KG.

Trade names are trademarks of the owners.

The following abbreviations are used throughout this manual: R&S®FSW is abbreviated as R&S FSW.

# Contents

<b>1</b>	<b>Preface</b> .....	<b>5</b>
1.1	About this Manual.....	5
1.2	Documentation Overview.....	5
1.3	Conventions Used in the Documentation.....	7
<b>2</b>	<b>Welcome to the WLAN Application</b> .....	<b>8</b>
2.1	Starting the WLAN Application.....	8
2.2	Understanding the Display Information.....	9
<b>3</b>	<b>Measurements and Result Displays</b> .....	<b>11</b>
3.1	Default WLAN Measurement (Modulation Accuracy, Flatness and Tolerance) .....	11
3.2	Measurements on RF Data.....	28
<b>4</b>	<b>Measurement Basics</b> .....	<b>35</b>
4.1	Signal Processing for the IEEE 802.11a Standard.....	35
4.2	Physical vs Effective Channels.....	42
4.3	Recognized vs. Analyzed PPDU.....	43
4.4	Demodulation Parameters - Logical Filters.....	43
4.5	Receiving Data Input and Providing Data Output.....	44
4.6	Preparing the R&S FSW for the Expected Input Signal - Frontend Parameters .....	46
4.7	Triggered measurements.....	47
<b>5</b>	<b>Configuration</b> .....	<b>50</b>
5.1	Multiple Measurement Channels and Sequencer Function.....	50
5.2	Display Configuration.....	52
5.3	Default WLAN Measurement (Modulation Accuracy, Flatness, Tolerance...) .....	52
5.4	RF (Frequency Domain) Measurements.....	89
<b>6</b>	<b>Analysis</b> .....	<b>93</b>
<b>7</b>	<b>How to Perform Measurements in the WLAN Application</b> .....	<b>94</b>
<b>8</b>	<b>Optimizing and Troubleshooting the Measurement</b> .....	<b>96</b>
8.1	Optimizing the Measurement Results.....	96

8.2	Error Messages and Warnings.....	97
<b>9</b>	<b>Remote Commands for WLAN Measurements.....</b>	<b>99</b>
9.1	Introduction.....	100
9.2	Activating WLAN Measurements.....	104
9.3	Selecting a Measurement.....	107
9.4	Configuring the Default WLAN Measurement (Modulation Accuracy, Flatness and Tolerance).....	111
9.5	Configuring Measurements on RF Data from WLAN Signals.....	150
9.6	Configuring the Result Display.....	150
9.7	Starting a Measurement.....	159
9.8	Retrieving Results.....	164
9.9	Analysis.....	187
9.10	Status Registers.....	190
9.11	Commands for Compatibility.....	194
9.12	Programming Examples (R&S FSW-K91).....	196
<b>A</b>	<b>Annex: Reference.....</b>	<b>201</b>
A.1	Sample Rate and Maximum Usable I/Q Bandwidth for RF Input.....	201
A.2	Reference: I/Q Data File Export Format (iq.tar).....	203
	<b>List of Remote Commands (WLAN).....</b>	<b>209</b>
	<b>Index.....</b>	<b>214</b>

# 1 Preface

## 1.1 About this Manual

This WLAN User Manual provides all the information **specific to the application**. All general instrument functions and settings common to all applications and operating modes are described in the main R&S FSW User Manual.

The main focus in this manual is on the measurement results and the tasks required to obtain them. The following topics are included:

- [chapter 2, "Welcome to the WLAN Application"](#), on page 8  
Introduction to and getting familiar with the application
- [chapter 3, "Measurements and Result Displays"](#), on page 11  
Details on supported measurements and their result types
- [chapter 4, "Measurement Basics"](#), on page 35  
Background information on basic terms and principles in the context of the measurement
- [chapter 5, "Configuration"](#), on page 50 and [chapter 6, "Analysis"](#), on page 93  
A concise description of all functions and settings available to configure measurements and analyze results with their corresponding remote control command
- [chapter 7, "How to Perform Measurements in the WLAN Application"](#), on page 94  
The basic procedure to perform each measurement and step-by-step instructions for more complex tasks or alternative methods
- [chapter 8, "Optimizing and Troubleshooting the Measurement"](#), on page 96  
Hints and tips on how to handle errors and optimize the test setup
- [chapter 9, "Remote Commands for WLAN Measurements"](#), on page 99  
Remote commands required to configure and perform WLAN measurements in a remote environment, sorted by tasks  
(Commands required to set up the environment or to perform common tasks on the instrument are provided in the main R&S FSW User Manual)  
Programming examples demonstrate the use of many commands and can usually be executed directly for test purposes
- [chapter A, "Annex: Reference"](#), on page 201  
Reference material
- **List of remote commands**  
Alphabetical list of all remote commands described in the manual
- **Index**

## 1.2 Documentation Overview

The user documentation for the R&S FSW consists of the following parts:

- "Getting Started" printed manual

- Online Help system on the instrument
- Documentation CD-ROM with:
  - Getting Started
  - User Manuals for base unit and options
  - Service Manual
  - Release Notes
  - Data sheet and product brochures

### Online Help

The Online Help is embedded in the instrument's firmware. It offers quick, context-sensitive access to the complete information needed for operation and programming. Online help is available using the  icon on the toolbar of the R&S FSW.

### Getting Started

This manual is delivered with the instrument in printed form and in PDF format on the CD. It provides the information needed to set up and start working with the instrument. Basic operations and handling are described. Safety information is also included.

The Getting Started manual in various languages is also available for download from the R&S website, on the R&S FSW product page at <http://www2.rohde-schwarz.com/product/FSW.html>.

### User Manuals

User manuals are provided for the base unit and each additional (software) option.

The user manuals are available in PDF format - in printable form - on the Documentation CD-ROM delivered with the instrument. In the user manuals, all instrument functions are described in detail. Furthermore, they provide a complete description of the remote control commands with programming examples.

The user manual for the base unit provides basic information on operating the R&S FSW in general, and the Spectrum application in particular. Furthermore, the software functions that enhance the basic functionality for various applications are described here. An introduction to remote control is provided, as well as information on maintenance, instrument interfaces and troubleshooting.

In the individual application manuals, the specific instrument functions of the application are described in detail. For additional information on default settings and parameters, refer to the data sheets. Basic information on operating the R&S FSW is not included in the application manuals.

All user manuals are also available for download from the R&S website, on the R&S FSW product page at <http://www2.rohde-schwarz.com/product/FSW.html>.

### Service Manual

This manual is available in PDF format on the CD delivered with the instrument. It describes how to check compliance with rated specifications, instrument function, repair, troubleshooting and fault elimination. It contains all information required for repairing the R&S FSW by replacing modules.

### Release Notes

The release notes describe the installation of the firmware, new and modified functions, eliminated problems, and last minute changes to the documentation. The corresponding firmware version is indicated on the title page of the release notes.

The most recent release notes are also available for download from the R&S website, on the R&S FSW product page at <http://www2.rohde-schwarz.com/product/FSW.html> > Downloads > Firmware.

## 1.3 Conventions Used in the Documentation

### 1.3.1 Typographical Conventions

The following text markers are used throughout this documentation:

Convention	Description
"Graphical user interface elements"	All names of graphical user interface elements on the screen, such as dialog boxes, menus, options, buttons, and softkeys are enclosed by quotation marks.
KEYS	Key names are written in capital letters.
File names, commands, program code	File names, commands, coding samples and screen output are distinguished by their font.
<i>Input</i>	Input to be entered by the user is displayed in italics.
<a href="#">Links</a>	Links that you can click are displayed in blue font.
"References"	References to other parts of the documentation are enclosed by quotation marks.

### 1.3.2 Conventions for Procedure Descriptions

When describing how to operate the instrument, several alternative methods may be available to perform the same task. In this case, the procedure using the touchscreen is described. Any elements that can be activated by touching can also be clicked using an additionally connected mouse. The alternative procedure using the keys on the instrument or the on-screen keyboard is only described if it deviates from the standard operating procedures.

The term "select" may refer to any of the described methods, i.e. using a finger on the touchscreen, a mouse pointer in the display, or a key on the instrument or on a keyboard.

## 2 Welcome to the WLAN Application

The R&S FSW WLAN application extends the functionality of the R&S FSW to enable accurate and reproducible TX measurements of a WLAN device under test (DUT) in accordance with the standards specified for the device (IEEE standards 802.11 a, n (SISO) and ac).

The R&S FSW WLAN application features:

### Modulation measurements

- Constellation diagram for demodulated signal
- Constellation diagram for individual carriers
- I/Q offset and I/Q imbalance
- Modulation error (EVM) for individual carriers or symbols
- Amplitude response and group-delay distortion (spectrum flatness)

### Further measurements and results

- Amplitude statistics (CCDF) and crest factor
- FFT, also over a selected part of the signal, e.g. preamble
- Payload bit information

This user manual contains a description of the functionality that is specific to the application, including remote control operation.

All functions not discussed in this manual are the same as in the base unit and are described in the R&S FSW User Manual. The latest version is available for download at the [product homepage](#).

### Installation

You can find detailed installation instructions in the R&S FSW Getting Started manual or in the Release Notes.

## 2.1 Starting the WLAN Application

The WLAN measurements require a special application on the R&S FSW.

### To activate the WLAN application

1. Press the MODE key on the front panel of the R&S FSW.

A dialog box opens that contains all operating modes and applications currently available on your R&S FSW.

2. Select the "WLAN" item.





The R&S FSW opens a new measurement channel for the WLAN application.

The measurement is started immediately with the default settings. It can be configured in the WLAN "Overview" dialog box, which is displayed when you select the "Overview" softkey from any menu (see [chapter 5.3.2, "Configuration Overview"](#), on page 54).

## 2.2 Understanding the Display Information

The following figure shows a measurement diagram during analyzer operation. All information areas are labeled. They are explained in more detail in the following sections.

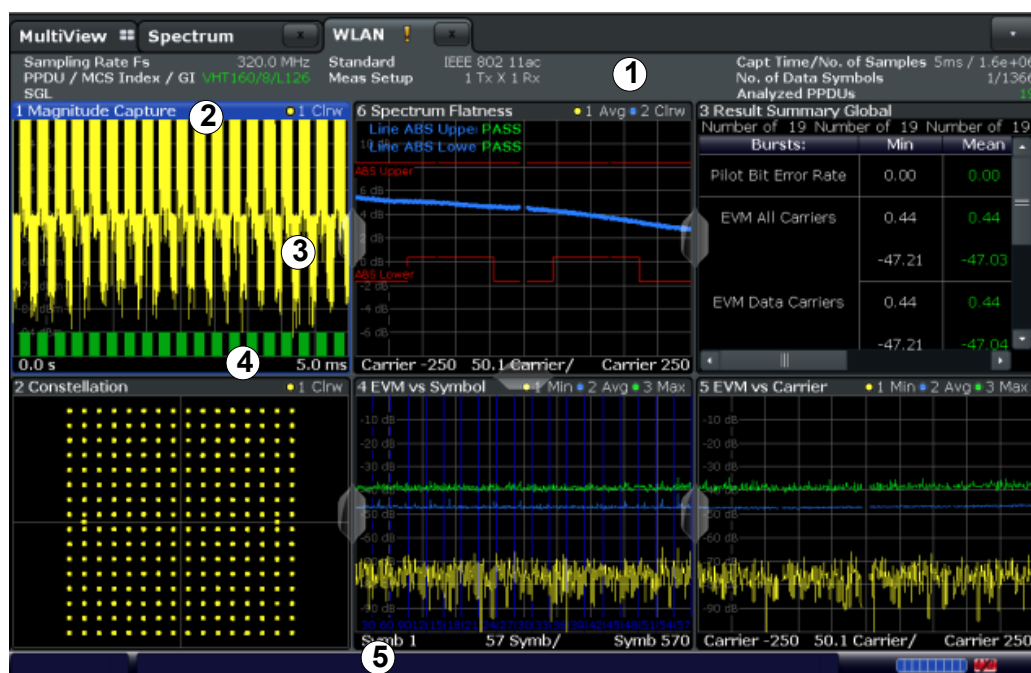

- 1 = Channel bar for firmware and measurement settings
- 2 = Window title bar with diagram-specific (trace) information
- 3 = Diagram area with marker information
- 4 = Diagram footer with diagram-specific information, depending on result display
- 5 = Instrument status bar with error messages, progress bar and date/time display

### Channel bar information

In the WLAN application, the R&S FSW shows the following settings:

**Table 2-1: Information displayed in the channel bar in the WLAN application**

Label	Description
Sampling Rate Fs	Input sample rate
PPDU / MCS Index / GI	The PPDU Type, MCS Index and Guard Interval used for the analysis of the signal is displayed. Depending on the demodulation settings, these values are either detected automatically from the signal or the user settings are applied.

Label	Description
Standard	Selected WLAN measurement standard
Meas Setup	Number of Transmitter (Tx) and Receiver (Rx) channels used in the measurement (currently always 1 TX+1 Rx)
Capt time / No. of Samples	Duration of signal capture and number of samples captured
No. of Data Symbols	The minimum and maximum number of data symbols that a PPDU may have if it is to be considered in results analysis.
Analyzed PPDU [x of y (z)]	For statistical evaluation over PPDU (see " <a href="#">PPDU Statistic Count / No of PPDU to Analyze</a> " on page 83): <x> PPDU of totally required <y> PPDU have been analyzed so far. <z> PPDU were analyzed in the most recent sweep.

In addition, the channel bar also displays information on instrument settings that affect the measurement results even though this is not immediately apparent from the display of the measured values (e.g. transducer or trigger settings). This information is displayed only when applicable for the current measurement. For details see the R&S FSW Getting Started manual.

### Window title bar information

For each diagram, the header provides the following information:



**Fig. 2-1: Window title bar information in the WLAN application**

- 1 = Window number
- 2 = Window type
- 3 = Trace color
- 4 = Trace number
- 6 = Trace mode

### Diagram footer information

The diagram footer (beneath the diagram) contains the start and stop values for the displayed x-axis range.

### Status bar information

Global instrument settings, the instrument status and any irregularities are indicated in the status bar beneath the diagram. Furthermore, the progress of the current operation is displayed in the status bar. Click on a displayed warning or error message to obtain more details (see also .

## 3 Measurements and Result Displays

The R&S FSW WLAN application provides several different measurements in order to determine the parameters described by the WLAN 802.11 specifications.

For details on selecting measurements see "[Selecting the measurement type](#)" on page 50.

- [Default WLAN Measurement \(Modulation Accuracy, Flatness and Tolerance\)](#).....11
- [Measurements on RF Data](#).....28

### 3.1 Default WLAN Measurement (Modulation Accuracy, Flatness and Tolerance)

The default WLAN measurement captures the I/Q data from the WLAN signal using a (nearly rectangular) filter with a relatively large bandwidth. The I/Q data captured with this filter includes magnitude and phase information, which allows the R&S FSW WLAN application to demodulate broadband signals and determine various characteristic signal parameters such as the modulation accuracy, spectrum flatness, center frequency tolerance and symbol clock tolerance in just one measurement.

Other parameters specified in the WLAN 802.11 standard require a better signal-to-noise level or a smaller bandwidth filter than the I/Q measurement provides and must be determined in separate measurements (see [chapter 3.2, "Measurements on RF Data"](#), on page 28).

- [Modulation Accuracy, Flatness and Tolerance Parameters](#).....11
- [Evaluation Methods for Default WLAN Measurements](#).....16

#### 3.1.1 Modulation Accuracy, Flatness and Tolerance Parameters

The default WLAN measurement (Modulation Accuracy, Flatness,...) captures the I/Q data from the WLAN signal and determines all the following I/Q parameters in a single sweep.

**Table 3-1: WLAN I/Q parameters**

Parameter	Description
Sampling Rate Fs	Input sample rate
PPDU	Number of the PPDU currently analyzed
MCS Index	Modulation and Coding Scheme (MCS) index of the analyzed PPDUs
GI	Guard interval length for current measurement
*) the limits can be changed via remote control (not manually, see <a href="#">chapter 9.4.9, "Limits"</a> , on page 145); in this case, the currently defined limits are displayed here	

## Default WLAN Measurement (Modulation Accuracy, Flatness and Tolerance)

Parameter	Description
Standard	Selected WLAN measurement standard
Meas Setup	Number of Transmitter (Tx) and Receiver (Rx) channels used in the measurement
Capture time	Duration of signal capture
No. of Samples	Number of samples captured
No. of Data Symbols	The minimum and maximum number of data symbols that a PPDU may have if it is to be considered in results analysis.
Analyzed PPDUs	For statistical evaluation of PPDUs (see "PPDU Statistic Count / No of PPDUs to Analyze" on page 83): <x> PPDUs of totally required <y> PPDUs have been analyzed so far. <z> indicates the number of analyzed PPDUs in the most recent sweep.
Number of recognized PPDUs (global)	Number of PPDUs recognized in capture buffer
Number of analyzed PPDUs (global)	Number of analyzed PPDUs in capture buffer
Number of analyzed PPDUs in physical channel	Number of PPDUs analyzed in entire signal (if available)
Pilot bit error rate [%]	
EVM all carriers [%/dB]	EVM (Error Vector Magnitude) of the payload symbols over all carriers; the corresponding limits specified in the standard are also indicated*)
EVM data carriers [%/dB]	EVM (Error Vector Magnitude) of the payload symbols over all data carriers; the corresponding limits specified in the standard are also indicated*)
EVM pilot carriers [%/dB]	EVM (Error Vector Magnitude) of the payload symbols over all pilot carriers; the corresponding limits specified in the standard are also indicated*)
Center frequency error [Hz]	Frequency error between the signal and the current center frequency of the R&S FSW; the corresponding limits specified in the standard are also indicated*) The absolute frequency error includes the frequency error of the R&S FSW and that of the DUT. If possible, the transmitter R&S FSW and the DUT should be synchronized (using an external reference). See R&S FSW User Manual > Instrument setup > External reference
Symbol clock error [ppm]	Clock error between the signal and the sample clock of the R&S FSW in parts per million (ppm), i.e. the symbol timing error; the corresponding limits specified in the standard are also indicated *) If possible, the transmitter R&S FSW and the DUT should be synchronized (using an external reference). See R&S FSW User Manual > Instrument setup > External reference
*) the limits can be changed via remote control (not manually, see <a href="#">chapter 9.4.9, "Limits"</a> , on page 145); in this case, the currently defined limits are displayed here	

## Default WLAN Measurement (Modulation Accuracy, Flatness and Tolerance)

Parameter	Description
I/Q offset [dB]	Transmitter center frequency leakage relative to the total Tx channel power (see <a href="#">chapter 3.1.1.1, "I/Q Offset"</a> , on page 13)
Gain imbalance [%/dB]	Amplification of the quadrature phase component of the signal relative to the amplification of the in-phase component (see <a href="#">chapter 3.1.1.2, "Gain Imbalance"</a> , on page 13)
Quadrature offset [°]	Deviation of the quadrature phase angle from the ideal 90° (see <a href="#">chapter 3.1.1.3, "Quadrature Offset"</a> , on page 14).
PPDU power [dBm]	Mean PPDU power
Crest factor [dB]	The ratio of the peak power to the mean power of the signal (also called Peak to Average Power Ratio, PAPR).
*) the limits can be changed via remote control (not manually, see <a href="#">chapter 9.4.9, "Limits"</a> , on page 145); in this case, the currently defined limits are displayed here	

The R&S FSW WLAN application also performs statistical evaluation over several PPDU and displays one or more of the following results:

**Table 3-2: Calculated summary results**

Result type	Description
Min	Minimum measured value
Mean/ Limit	Mean measured value / limit defined in standard
Max/Limit	Maximum measured value / limit defined in standard

### 3.1.1.1 I/Q Offset

An I/Q offset indicates a carrier offset with fixed amplitude. This results in a constant shift of the I/Q axes. The offset is normalized by the mean symbol power and displayed in dB.

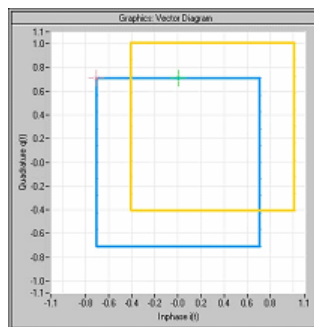

**Fig. 3-1: I/Q offset in a vector diagram**

### 3.1.1.2 Gain Imbalance

An ideal I/Q modulator amplifies the I and Q signal path by exactly the same degree. The imbalance corresponds to the difference in amplification of the I and Q channel and

## Default WLAN Measurement (Modulation Accuracy, Flatness and Tolerance)

therefore to the difference in amplitude of the signal components. In the vector diagram, the length of the I vector changes relative to the length of the Q vector.

The result is displayed in dB and %, where 1 dB offset corresponds to roughly 12 % difference between the I and Q gain, according to the following equation:

$$\text{Imbalance [dB]} = 20 \log (| \text{Gain}_Q | / | \text{Gain}_I |)$$

Positive values mean that the Q vector is amplified more than the I vector by the corresponding percentage. For example using the figures mentioned above:

$$0.98 \approx 20 * \log_{10}(1.12/1)$$

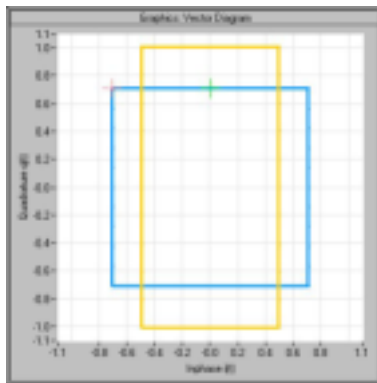

**Fig. 3-2: Positive gain imbalance**

Negative values mean that the I vector is amplified more than the Q vector by the corresponding percentage. For example using the figures mentioned above:

$$-0.98 \approx 20 * \log_{10}(1/1.12)$$

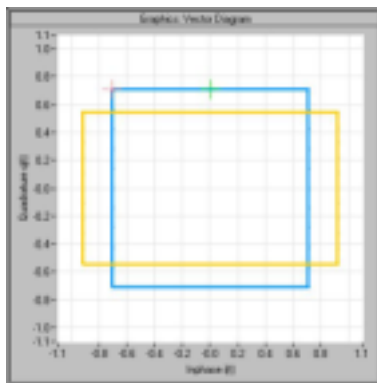
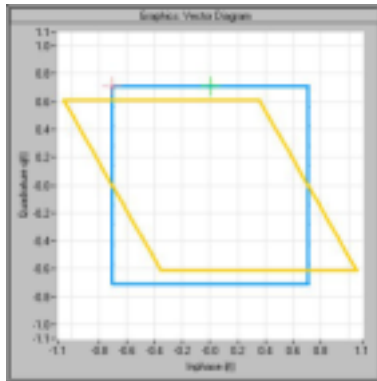

**Fig. 3-3: Negative gain imbalance**

### 3.1.1.3 Quadrature Offset

An ideal I/Q modulator sets the phase angle between the I and Q path mixer to exactly 90 degrees. With a quadrature offset, the phase angle deviates from the ideal 90 degrees, the amplitudes of both components are of the same size. In the vector diagram, the quadrature offset causes the coordinate system to shift.

A positive quadrature offset means a phase angle greater than 90 degrees:



**Fig. 3-4: Positive quadrature offset**

A negative quadrature offset means a phase angle less than 90 degrees:

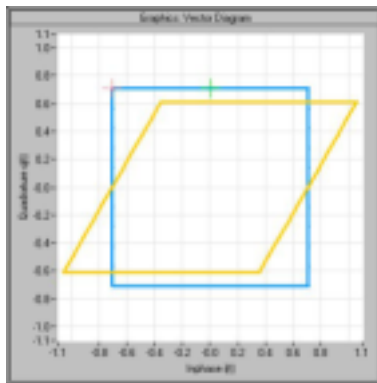

**Fig. 3-5: Negative quadrature offset**

### 3.1.1.4 EVM Measurement

#### PPDU EVM (Direct)

The PPDU EVM (Direct) method evaluates the root mean square EVM over one PPDU. That is the square root of the averaged error power normalized by the averaged reference power:

$$EVM = \sqrt{\frac{\sum_{n=0}^{N-1} |x_{meas}(n) - x_{ref}(n)|^2}{\sum_{n=0}^{N-1} |x_{ref}(n)|^2}} = \sqrt{\frac{\sum_{n=0}^{N-1} |e(n)|^2}{\sum_{n=0}^{N-1} |x_{ref}(n)|^2}}$$

Before calculation of the EVM, tracking errors in the measured signal are compensated for if specified by the user. In the ideal reference signal, the tracking errors are always compensated for. Tracking errors include phase (center frequency error + common phase

error), timing (sampling frequency error) and gain errors. I/Q offset and I/Q imbalance errors, however, are not corrected.

The PPDU EVM is not part of the IEEE standard and no limit check is specified. Nevertheless, this commonly used EVM calculation can provide some insight in modulation quality and enables comparisons to other modulation standards.

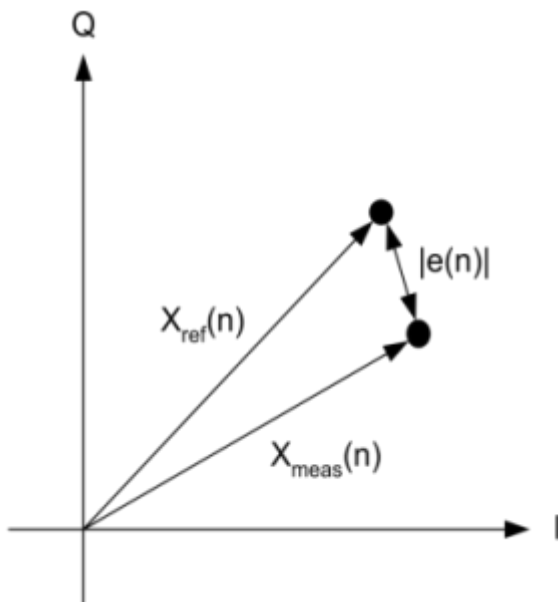

Fig. 3-6: I/Q diagram for EVM calculation

### 3.1.2 Evaluation Methods for Default WLAN Measurements

The captured I/Q data from the WLAN signal can be evaluated using various different methods without having to start a new measurement or sweep. Which results are displayed depends on the selected evaluation.

The selected evaluation method not only affects the result display in a window, but also the results of the trace data query in remote control (see [TRACe<n> \[ :DATA \]](#) on page 177).

All evaluations available for the selected WLAN measurement are displayed in SmartGrid mode.

To activate SmartGrid mode, do one of the following:

- 
  - Select the "SmartGrid" icon from the toolbar.
- Select the "Display Config" button in the configuration "Overview" (see ).
- Press the MEAS CONFIG hardkey and then select the "Display Config" softkey.

To close the SmartGrid mode and restore the previous softkey menu select the  "Close" icon in the righthand corner of the toolbar, or press any key on the front panel.



The WLAN measurements provide the following evaluation methods:

Bitstream.....	17
Constellation.....	17
Constellation vs Carrier.....	18
EVM vs Carrier.....	19
EVM vs Symbol.....	19
FFT Spectrum.....	20
Group Delay.....	21
Magnitude Capture.....	21
PvT Full PPDU.....	22
Result Summary Detailed.....	22
Result Summary Global.....	24
Signal Field.....	24
Spectrum Flatness.....	27

### Bitstream

This result display shows the demodulated payload data stream for all analyzed PPDU's of the currently captured I/Q data as indicated in the "Magnitude Capture" display. The bitstream is derived from the constellation diagram points using the 'constellation bit encoding' from the corresponding WLAN standard. See for example *IEEE Std. 802.11-2012 'Fig. 18-10 BPSK, QPSK, 16-QAM and 64-QAM constellation bit encoding'*. Thus, the bitstream is *NOT* channel-decoded.

The results are grouped by symbol and carrier.

The numeric trace results for this evaluation method are described in [chapter 9.8.4.1, "Bitstream"](#), on page 182.

SCPI command:

LAY:ADD? '1',RIGH, BITS, see [LAYout:ADD\[:WINDow\]?](#) on page 152

or:

CONFigure:BURSt:STATistics:BSTReam[:IMMediate] on page 110

### Constellation

This result display shows the in-phase and quadrature phase results for all payload symbols and all carriers for the analyzed PPDU's of the current capture buffer. The Tracking/Channel Estimation according to the user settings is applied.

The inphase results (I) are displayed on the x-axis, the quadrature phase (Q) results on the y-axis.

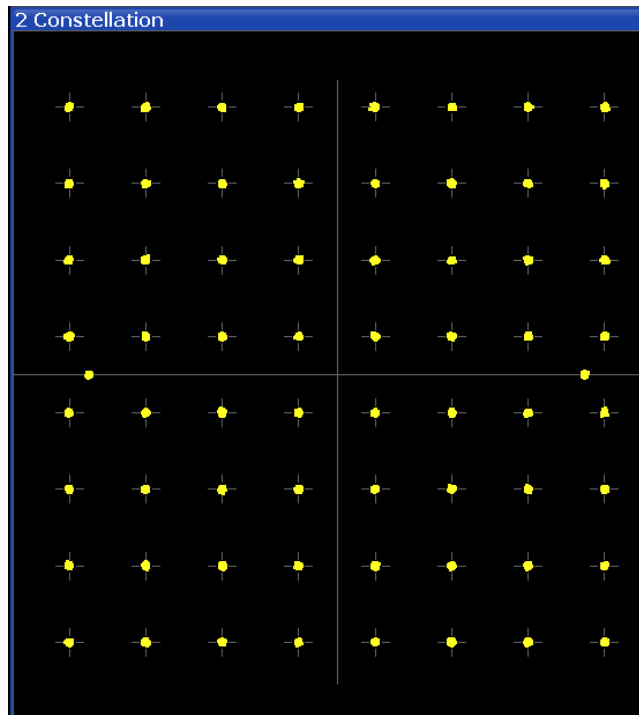

The numeric trace results for this evaluation method are described in [chapter 9.8.4.3, "Constellation"](#), on page 182.

SCPI command:

LAY:ADD? '1', RIGH, CONS, see [LAYout:ADD\[:WINDow\]?](#) on page 152

or:

[CONFigure:BURSt:CONSt:CSYMBOL\[:IMMediate\]](#) on page 109

#### Constellation vs Carrier

This result display shows the in-phase and quadrature phase results for all payload symbols and all carriers for the analyzed PPDU of the current capture buffer. The Tracking/Channel Estimation according to the user settings is applied.

The x-axis represents the carriers. The magnitude of the in-phase and quadrature part is shown on the y-axis, both are displayed as separate traces (I-> trace 1, Q-> trace 2).

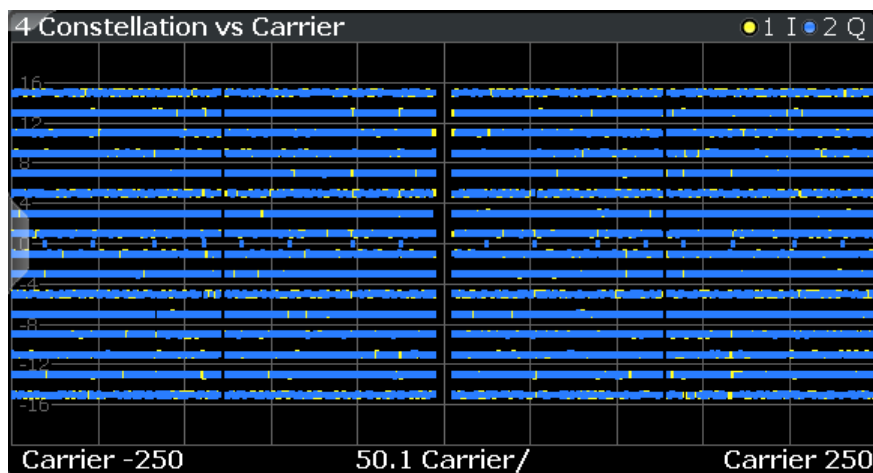

## Default WLAN Measurement (Modulation Accuracy, Flatness and Tolerance)

The numeric trace results for this evaluation method are described in [chapter 9.8.4.4, "Constellation vs Carrier"](#), on page 183.

SCPI command:

LAY:ADD? '1',RIGH, CVC, see [LAYout:ADD\[:WINDow\]?](#) on page 152

or:

[CONFigure:BURSt:CONSt:CCARrier\[:IMMediate\]](#) on page 108

### EVM vs Carrier

This result display shows all EVM values recorded on a per-subcarrier basis over the number of analyzed PPDU's as defined by the "Evaluation Range > Statistics". The Tracking/Channel Estimation according to the user settings is applied (see [chapter 5.3.7, "Tracking and Channel Estimation"](#), on page 74). The Minhold, Average and Maxhold traces are displayed.

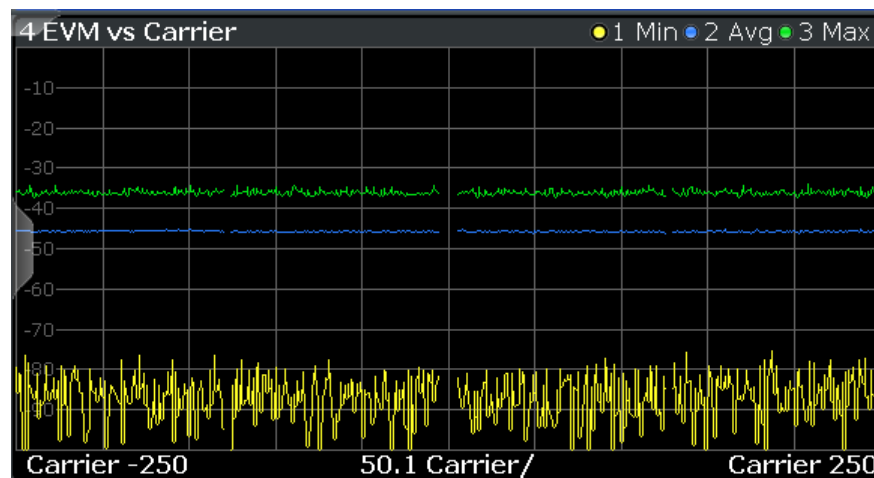

The numeric trace results for this evaluation method are described in [chapter 9.8.4.5, "EVM vs Carrier"](#), on page 184.

SCPI command:

LAY:ADD? '1',RIGH, EVC, see [LAYout:ADD\[:WINDow\]?](#) on page 152

or:

[CONFigure:BURSt:EVM:ECARrier\[:IMMediate\]](#) on page 109

### EVM vs Symbol

This result display shows all EVM values calculated on a per-carrier basis over the number of analyzed PPDU's as defined by the "Evaluation Range > Statistics" settings (see ["PPDU Statistic Count / No of PPDU's to Analyze"](#) on page 83). The Tracking/Channel Estimation according to the user settings is applied (see [chapter 5.3.7, "Tracking and Channel Estimation"](#), on page 74). The MinHold, Maxhold, and Average traces are displayed.

## Default WLAN Measurement (Modulation Accuracy, Flatness and Tolerance)

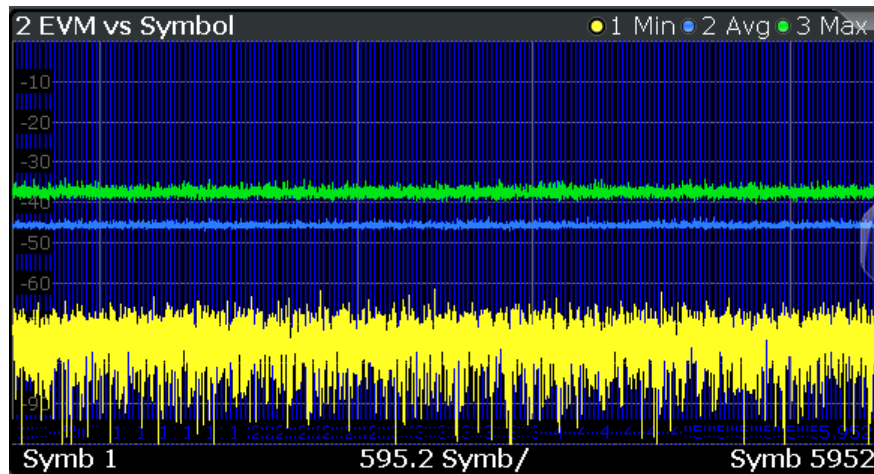

SCPI command:

LAY:ADD? '1',RIGH, EVS, see LAYout:ADD[:WINDow]? on page 152

or:

CONFigure:BURSt:EVM:ESYMBOL[:IMMediate] on page 109

### FFT Spectrum

This result display shows the power vs frequency values obtained from a FFT. The FFT is performed over the complete data in the current capture buffer, without any correction or compensation.

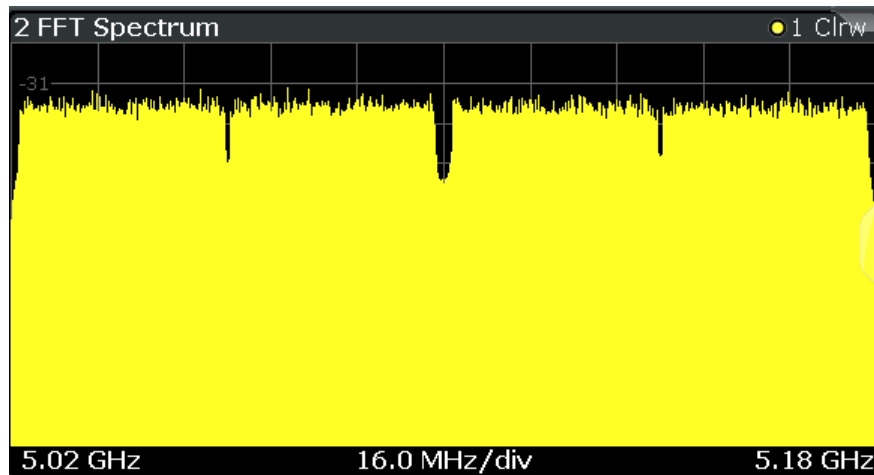

The numeric trace results for this evaluation method are described in [chapter 9.8.4.6, "FFT Spectrum"](#), on page 184.

SCPI command:

LAY:ADD? '1',RIGH, FSP, see LAYout:ADD[:WINDow]? on page 152

or:

CONFigure:BURSt:SPECTrum:FFT[:IMMediate] on page 109

### Group Delay

Displays all Group Delay (GD) values recorded on a per-subcarrier basis - over the number of analyzed PPDU's as defined by the "Evaluation Range > Statistics" settings (see "PPDU Statistic Count / No of PPDU's to Analyze" on page 83).

All 57 carriers are shown, including the unused carrier 0.

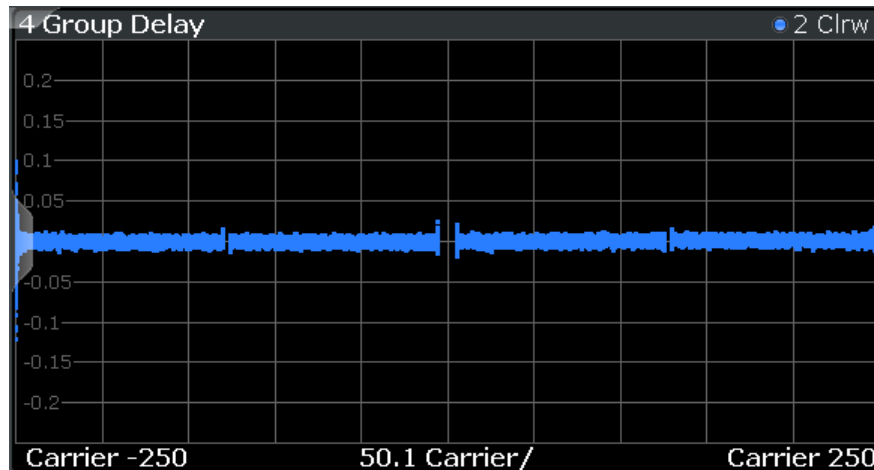

Group delay is a measure of phase distortion and defined as the derivation of phase over frequency.

To calculate the group delay, the estimated channel is upsampled, inactive carriers are interpolated and phases are unwrapped before they are differentiated over the carrier frequencies. Thus, the group delay indicates the time a pulse in the channel is delayed for each carrier frequency. However, not the absolute delay is of interest, but rather the deviation between carriers. Thus, the mean delay over all carriers is deducted.

For an ideal channel, the phase increases linearly, which causes a constant time delay over all carriers. In this case, a horizontal line at the zero value would be the result.

The numeric trace results for this evaluation method are described in [chapter 9.8.4.7, "Group Delay"](#), on page 184.

SCPI command:

LAY:ADD? '1',RIGH, GDEL, see [LAYout:ADD\[:WINDow\]?](#) on page 152

or:

CONF:BURS:SPEC:FLAT:SEL GRD, see [CONFigure:BURSt:SPECTrum:FLATness:SElect](#) on page 109 and

[CONFigure:BURSt:SPECTrum:FLATness\[:IMMediate\]](#) on page 110

### Magnitude Capture

The Magnitude Capture Buffer display shows the complete range of captured data for the last sweep. Green bars at the bottom of the Magnitude Capture Buffer display indicate the positions of the analyzed PPDU's.

## Default WLAN Measurement (Modulation Accuracy, Flatness and Tolerance)

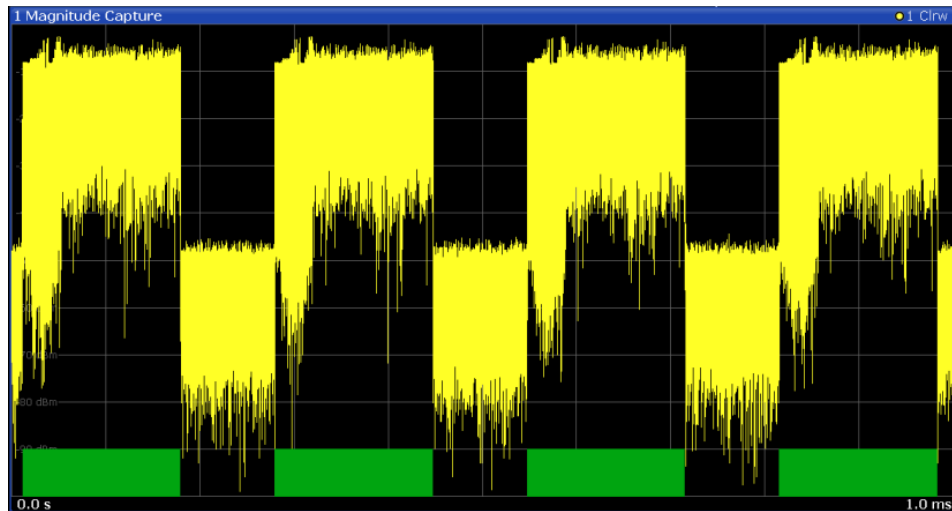

Numeric trace results are not available for this evaluation method.

SCPI command:

LAY:ADD? '1',RIGHT, CMEM, see [LAYout:ADD\[:WINDOW\]? on page 152](#)

### PvT Full PPDU

Displays the Power vs Time diagram for all PPDU.

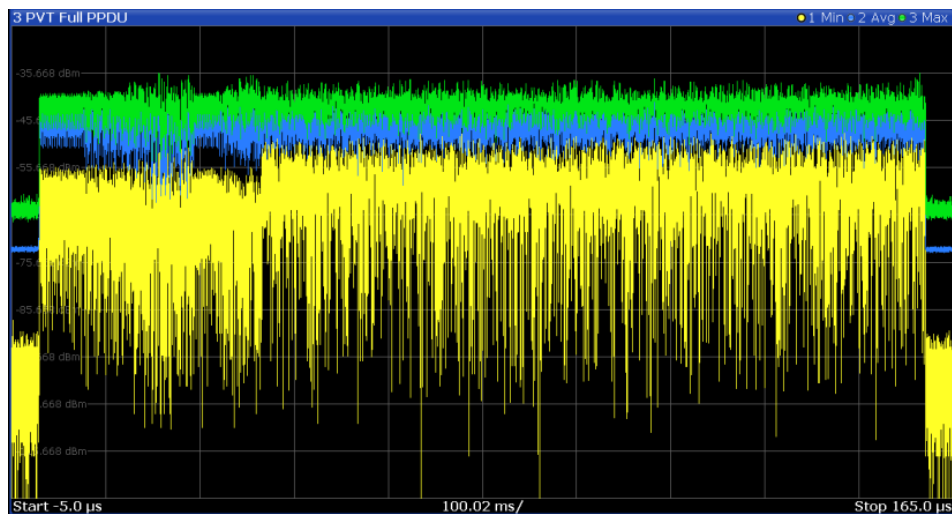

SCPI command:

LAY:ADD:WIND '2',RIGHT,PFPP see [LAYout:ADD\[:WINDOW\]? on page 152](#)

### Result Summary Detailed

The *detailed* result summary contains individual measurement results for the Transmitter and Receiver channels and for the bitstream.

## Default WLAN Measurement (Modulation Accuracy, Flatness and Tolerance)

1 Result Summary Global						
PPDUs:	Min	Mean	Limit	Max	Limit	Unit
Pilot Bit Error Rate	0.00	0.00	0.00	0.00	0.00	%
EVM All Carriers	0.47	0.48	5.62	0.48	5.62	%
	-46.47	-46.41	-25.00	-46.36	-25.00	dB
EVM Data Carriers	0.47	0.48	5.62	0.48	5.62	%
	-46.48	-46.41	-25.00	-46.35	-25.00	dB
EVM Pilot Carriers	0.45	0.47	56.23	0.49	56.23	%
	-46.97	-46.61	-5.00	-46.21	-5.00	dB
Center Frequency Error	-4.74	-1.23	±112000.00	2.23	±112000.00	Hz
Symbol Clock Error	-7.72	-7.71	±20.00	-7.70	±20.00	ppm

The "Result Summary Detailed" contains the following information:

**Note:** You can configure which results are displayed (see [chapter 5.3.10, "Result Configuration"](#), on page 84). However, the results are always calculated, regardless of their visibility.

TX channel ("Tx All"):

- I/Q Offset [dB]
- Gain imbalance [%/dB]
- Quadrature offset [°]
- PPDU power [dBm]
- Crest factor [dB]

Receive channel ("Rx All"):

- PPDU power [dBm]
- Crest factor [dB]

Bitstream ("Stream All"):

- Pilot bit error rate [%]
- EVM all carriers [%/dB]
- EVM data carriers [%/dB]
- EVM pilot carriers [%/dB]

For details on the individual parameters and the summarized values see [chapter 3.1.1, "Modulation Accuracy, Flatness and Tolerance Parameters"](#), on page 11.

SCPI command:

LAY:ADD? '1',RIGH, RSD, see [LAYout:ADD\[:WINDow\]?](#) on page 152

## Default WLAN Measurement (Modulation Accuracy, Flatness and Tolerance)

## Result Summary Global

1 Result Summary Global						
No. of PPDUs - Recognized: 19		Analyzed: 18		Analyzed Physical Channel: 18		
PPDUs:	Min	Mean	Limit	Max	Limit	Unit
Pilot Bit Error Rate	0.00	0.00	0.00	0.00	0.00	%
EVM All Carriers	0.34	0.38	31.62	0.49	31.62	%
	-49.25	-48.46	-10.00	-46.15	-10.00	dB
EVM Data Carriers	0.34	0.38	31.62	0.50	31.62	%
	-49.25	-48.44	-10.00	-46.07	-10.00	dB
EVM Pilot Carriers	0.29	0.34	56.23	0.45	56.23	%
	-50.62	-49.31	-5.00	-46.99	-5.00	dB
Center Frequency Error	-4.34	-0.85	±100000.00	3.55	±100000.00	Hz
Symbol Clock Error	0.02	0.09	±20.00	0.17	±20.00	ppm

The *global* result summary provides measurement results based on the complete signal, consisting of all channels and streams. The observation length is the number of PPDUs to be analyzed as defined by the "Evaluation Range > Statistics" settings. In contrast, the *detailed* result summary provides results for each individual channel and stream.

The "Result Summary Global" contains the following information:

**Note:** You can configure which results are displayed (see [chapter 5.3.10, "Result Configuration"](#), on page 84). However, the results are always calculated, regardless of their visibility.

- Number of recognized PPDUs
- Number of analyzed PPDUs
- Number of analyzed PPDUs in entire physical channel (if available)
- Pilot bit error rate [%]
- EVM all carriers [%/dB]
- EVM data carriers [%/dB]
- EVM pilot carriers [%/dB]
- Center frequency error [Hz]
- Symbol clock error [ppm]

For details on the individual results and the summarized values see [chapter 3.1.1, "Modulation Accuracy, Flatness and Tolerance Parameters"](#), on page 11.

SCPI command:

LAY:ADD? '1',RIGH, RSG, see [LAYout:ADD\[:WINDow\]?](#) on page 152

### Signal Field

This result display shows the decoded data from the "Signal" field of each recognized PDU. This field contains information on the modulation used for transmission.



## Default WLAN Measurement (Modulation Accuracy, Flatness and Tolerance)

Format	MCS	CBW	HT-SIG Len / Sym	SNRA	STBC	GI	Ness	CRC	Tail
HT-MF	0110000 6	1 40	000000000100000 Sig 17 / Est 17	1110	00 0	0 L	00 0	10111001 0x10011101	000000
HT-MF	0110000 6	1 40	000000000100000 Sig 17 / Est 17	1110	00 0	0 L	00 0	10111001 0x10011101	000000
HT-MF	0110000 6	1 40	000000000100000 Sig 17 / Est 17	1110	00 0	0 L	00 0	10111001 0x10011101	000000
HT-MF	0110000 6	1 40	000000000100000 Sig 17 / Est 17	1110	00 0	0 L	00 0	10111001 0x10011101	000000
HT-MF	0110000 6	1 40	000000000100000 Sig 17 / Est 17	1110	00 0	0 L	00 0	10111001 0x10011101	000000

Fig. 3-7: Signal Field display for IEEE 802.11n

The signal field information is provided as a decoded bit sequence and, where appropriate, also in human-readable form, beneath the bit sequence for each PPDU.

The currently applied demodulation settings (as defined by the user, see [chapter 5.3.8, "Demodulation"](#), on page 76) are indicated beneath the table header for reference. Since the demodulation settings define which PPDUs are to be analyzed, this *logical filter* may be the reason if the "Signal Field" display is not as expected.

Table 3-3: Demodulation parameters and results for Signal Field result display (IEEE 802.11a)

Parameter	Description
Format	PPDU format used for measurement (Not part of the IEEE 802.11 a signal field, displayed for convenience; see <a href="#">"PPDU Format to measure"</a> on page 77)
CBW	Channel bandwidth to measure (Not part of the signal field, displayed for convenience)
Rate / Mbit/s	Symbol rate per second
R	Reserved bit
Length / Sym	Human-readable length of payload in OFDM symbols
P	Parity bit
(Signal) Tail	Signal tail (preset to 0)

Table 3-4: Demodulation parameters and results for Signal Field result display (IEEE 802.11n)

Parameter	Description
Format	PPDU format used for measurement (Not part of the IEEE 802.11 signal field, displayed for convenience; see <a href="#">"PPDU Format to measure"</a> on page 77)
MCS	Modulation and Coding Scheme (MCS) index of the PPDU as defined in IEEE Std 802.11-2012 section "20.6 Parameters for HT MCSs"
CBW	Channel bandwidth to measure 0: 20 MHz or 40 MHz upper/lower 1: 40 MHz
HT-SIG Length / Sym	Human-readable length of payload in OFDM symbols The number of octets of data in the PSDU in the range of 0 to 65 535

## Default WLAN Measurement (Modulation Accuracy, Flatness and Tolerance)

Parameter	Description
SNRA	<b>Smoothing/Not Sounding/Reserved/Aggregation:</b> <b>Smoothing:</b> 1: channel estimate smoothing is recommended 0: only per-carrier independent (unsmoothed) channel estimate is recommended <b>Not Sounding:</b> 1: PPDU is not a sounding PPDU 0: PPDU is a sounding PPDU <b>Reserved:</b> Set to 1 <b>Aggregation:</b> 1: PPDU in the data portion of the packet contains an AMPDU 0: otherwise
STBC	Space-Time Block Coding 00: no STBC (NSTS = NSS) ≠0: the difference between the number of spacetime streams (NSTS) and the number of spatial streams (NSS) indicated by the MCS
GI	Guard interval length PPDU must have to be measured 1: short GI used after HT training 0: otherwise
Ness	Number of extension spatial streams ( $N_{ESS}$ , see <a href="#">"Extension Spatial Streams (sounding) (IEEE 802.11 N)"</a> on page 81)
CRC	Cyclic redundancy code of bits 0–23 in HT-SIG1 and bits 0–9 in HT-SIG2
Tail Bits	Used to terminate the trellis of the convolution coder. Set to 0.

**Table 3-5: Demodulation parameters and results for Signal Field result display (IEEE 802.11ac)**

Parameter	Description
Format	PPDU format used for measurement (Not part of the IEEE 802.11 signal field, displayed for convenience; see <a href="#">"PPDU Format to measure"</a> on page 77)
MCS	Modulation and Coding Scheme (MCS) index of the PPDU as defined in IEEE Std 802.11-2012 section "20.6 Parameters for HT MCSs"
BW	Channel bandwidth to measure 0: 20 MHz 1: 40 MHz 2: 80 MHz 3: 80+80 MHz and 160MHz
L-SIG Length / Sym	Human-readable length of payload in OFDM symbols
STBC	Space-Time Block Coding 0: no spatial streams of any user has space time block coding 1: all spatial streams of all users have space time block coding
GI	Guard interval length PPDU must have to be measured 1: short guard interval is used in the Data field 0: short guard interval is not used in the Data field

## Default WLAN Measurement (Modulation Accuracy, Flatness and Tolerance)

Parameter	Description
N <sub>ESS</sub>	Number of extension spatial streams (N <sub>ESS</sub> , see <a href="#">"Extension Spatial Streams (sounding) (IEEE 802.11 N)"</a> on page 81)
CRC	Cyclic redundancy code

The values for the individual demodulation parameters are described in [chapter 5.3.8, "Demodulation"](#), on page 76. The following abbreviations are used in the "Signal Field" table:

**Table 3-6: Abbreviations for demodulation parameters shown in "Signal Field" display**

Abbreviation in "Signal Field" display	Parameter in "Demodulation" settings
A1st	Auto, same type as first PPDU
AI	Auto, individual for each PPDU
M<x>	Meas only the specified PDUs (<x>)
D<x>	Demod all with specified parameter <y>

The Signal Field measurement indicates certain inconsistencies in the signal or discrepancies between the demodulation settings and the signal to be analyzed. In both cases, an appropriate warning is displayed and the results for the PPDU are highlighted orange - both in the "Signal Field" display and the "Magnitude Capture" display. If the signal was analyzed with warnings the results – indicated by a message - also contribute to the overall analysis results.

PDUs detected in the signal that do not pass the logical filter, i.e. are not to be included in analysis, are dismissed. An appropriate message is provided. The corresponding PDU in the capture buffer is not highlighted.

The numeric trace results for this evaluation method are described in [chapter 9.8.4.9, "Signal Field"](#), on page 185.

SCPI command:

LAY:ADD? '1',RIGH, SFI, see [LAYout:ADD\[:WINDow\]?](#) on page 152

or:

[CONFigure:BURSt:STATistics:SFIeld\[:IMMediate\]](#) on page 110

### Spectrum Flatness

The Spectrum Flatness trace is derived from the magnitude of the estimated channel transfer function. Since this estimated channel is calculated from all payload symbols of the PPDU, it represents a carrier-wise mean gain of the channel. Assuming that we have a cable connection between DUT and R&S FSW that adds no residual channel distortion, the "Spectrum Flatness" shows the spectral distortion caused by the DUT (e.g. the transmit filter).

The diagram shows the absolute power per carrier. All 57 carriers are displayed, including the unused carrier 0.

In contrast to the SISO measurements in previous R&S signal and spectrum analyzers, the trace is no longer normalized to 0 dB (scaled by the mean gain of all carriers).

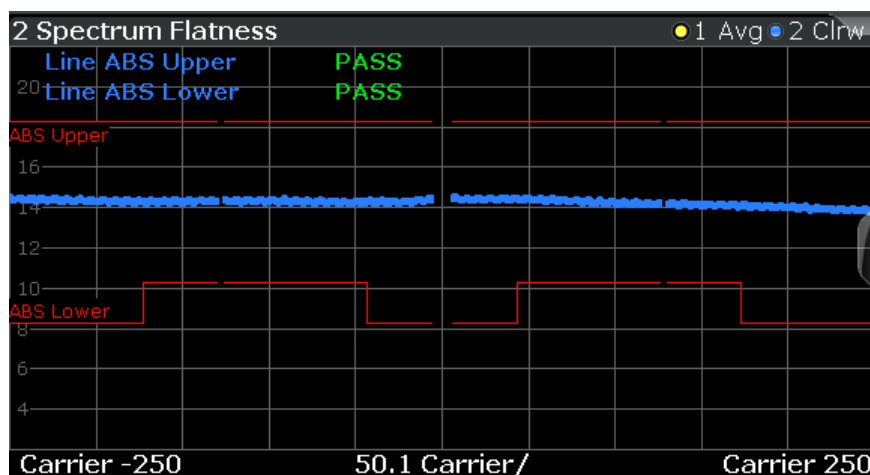

The numeric trace results for this evaluation method are described in [chapter 9.8.4.10, "Spectrum Flatness"](#), on page 185.

SCPI command:

LAY:ADD? '1',RIGHT, SFL, see [LAYout:ADD\[:WINDow\]?](#) on page 152

or:

CONF:BURS:SPEC:FLAT:SEL FLAT (see [CONFigure:BURSt:SPECtrum:FLATness:SElect](#) on page 109) and

[CONFigure:BURSt:SPECtrum:FLATness\[:IMMediate\]](#) on page 110

## 3.2 Measurements on RF Data

As described above, the default WLAN measurement captures the I/Q data from the WLAN signal using a (nearly rectangular) filter with a relatively large bandwidth. However, some parameters specified in the WLAN 802.11 standard require a better signal-to-noise level or a smaller bandwidth filter than the I/Q measurement provides and must be determined in separate measurements.

Parameters that are common to several digital standards and are often required in signal and spectrum test scenarios can be determined by the standard measurements provided in the R&S FSW base unit (Spectrum application). These measurements are performed using a much narrower bandwidth filter, and they capture only the power level (magnitude, which we refer to as *RF data*) of the signal, as opposed to the two components provided by I/Q data.

Measurements on RF data can tune on a constant frequency ("Zero span measurement") or sweep a frequency range ("Frequency sweep measurement")

The signal cannot be demodulated based on the captured RF data. However, the required power information can be determined much more precisely, as more noise is filtered out of the signal.

The measurements on RF data provided by the R&S FSW WLAN application are identical to the corresponding measurements in the base unit, but are pre-configured according to the requirements of the selected WLAN 802.11 standard.

For details on these measurements see the R&S FSW User Manual.

The R&S FSW WLAN application provides the following measurements on RF data:

### 3.2.1 Measurement Types and Results for RF Data

The R&S FSW WLAN application provides the following pre-configured measurements on RF data:

Channel Power ACLR.....	29
Spectrum Emission Mask.....	29
Occupied Bandwidth.....	30
CCDF.....	31

#### Channel Power ACLR

Channel Power ACLR performs an adjacent channel power (also known as adjacent channel leakage ratio) measurement according to WLAN 802.11 specifications.

The R&S FSW measures the channel power and the relative power of the adjacent channels and of the alternate channels. The results are displayed in the Result Summary.

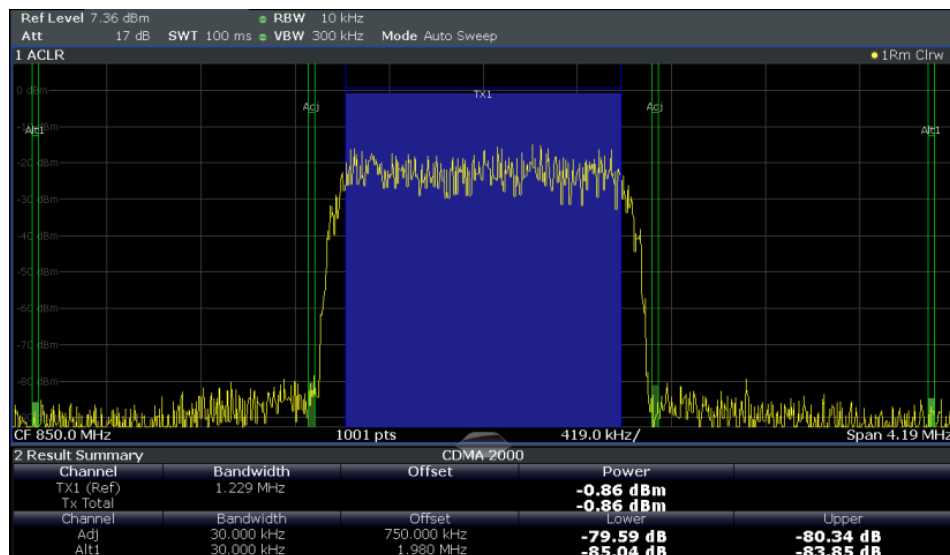

For details see [chapter 5.4.1, "Channel Power \(ACLR\) Measurements"](#), on page 89.

SCPI command:

[CONFigure: BURSt: SPECTrum: ACPR\[: IMMEDIATE\]](#) on page 111

Querying results:

[CALC: MARK: FUNC: POW: RES?](#) ACP, see [CALCulate<n>: MARKer<m>: FUNCtion: POWer: RESult?](#) on page 174

#### Spectrum Emission Mask

The Spectrum Emission Mask (SEM) measurement determines the power of the WLAN signal in defined offsets from the carrier and compares the power values with a spectral mask specified by the WLAN 802.11 specifications. The limits depend on the selected bandclass. Thus, the performance of the DUT can be tested and the emissions and their distance to the limit be identified.

**Note:** The WLAN 802.11 standard does not distinguish between spurious and spectral emissions.

For details see [chapter 5.4.2, "Spectrum Emission Mask"](#), on page 90.

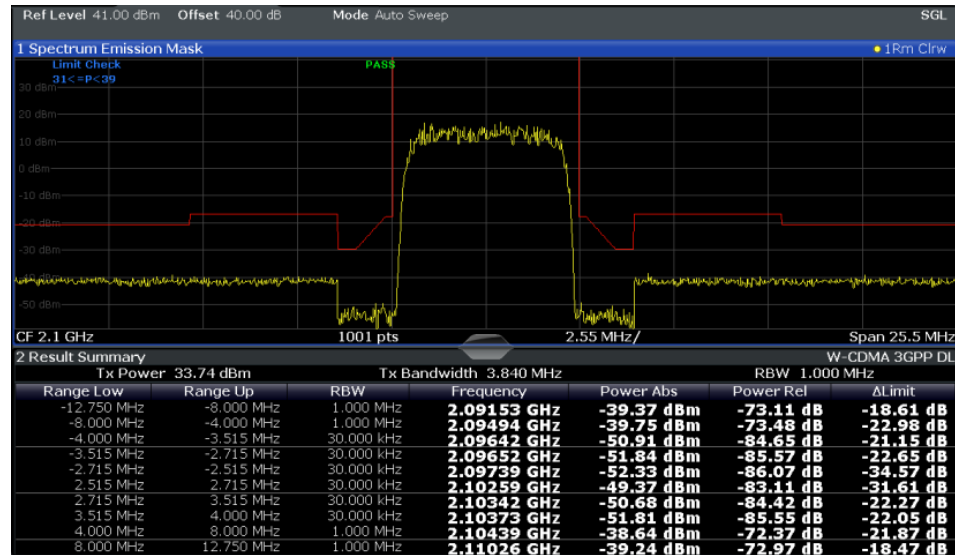

**Fig. 3-8: SEM measurement results**

SCPI command:

[CONFigure: BURSt: SPECTrum: MASK\[: IMMEDIATE\]](#) on page 111

Querying results:

[CALCulate<n>: LIMit<k>: FAIL](#) on page 173

[TRAC: DATA? LIST](#), see [TRACe<n>\[: DATA\]](#) on page 177

### Occupied Bandwidth

The Occupied Bandwidth (OBW) measurement determines the bandwidth in which – in default settings - 99 % of the total signal power is to be found. The percentage of the signal power to be included in the bandwidth measurement can be changed.

The occupied bandwidth is indicated as the "Occ BW" function result in the marker table; the frequency markers used to determine it are also displayed.



For details see [chapter 5.4.3, "Occupied Bandwidth"](#), on page 91.

SCPI command:

`CONFigure:BURSt:SPECTrum:OBWidth[:IMMediate]` on page 111

Querying results:

`CALC:MARK:FUNC:POW:RES? OBW`, see `CALCulate<n>:MARKer<m>:FUNctIon:POWer:RESult?` on page 174

### CCDF

The CCDF (complementary cumulative distribution function) measurement determines the distribution of the signal amplitudes. The measurement captures a user-definable amount of samples and calculates their mean power. As a result, the probability that a sample's power is higher than the calculated mean power + x dB is displayed. The crest factor is displayed in the Result Summary.

For details see [chapter 5.4.4, "CCDF"](#), on page 92.



Fig. 3-9: CCDF measurement results

SCPI command:

[CONFigure:BURSt:STATistics:CCDF\[:IMMediate\]](#) on page 111

Querying results:

[CALCulate<n>:MARKer<m>:Y?](#) on page 187

[CALCulate<n>:STATistics:RESult<t>](#) on page 175

### 3.2.2 Evaluation Methods for Measurements on RF Data

The evaluation methods for measurements on RF data in the R&S FSW WLAN application are identical to those in the R&S FSW base unit (Spectrum application).

<a href="#">Diagram</a> .....	32
<a href="#">Result Summary</a> .....	33
<a href="#">Marker Table</a> .....	33
<a href="#">Marker Peak List</a> .....	33

#### Diagram

Displays a basic level vs. frequency or level vs. time diagram of the measured data to evaluate the results graphically. This is the default evaluation method. Which data is displayed in the diagram depends on the "Trace" settings. Scaling for the y-axis can be configured.



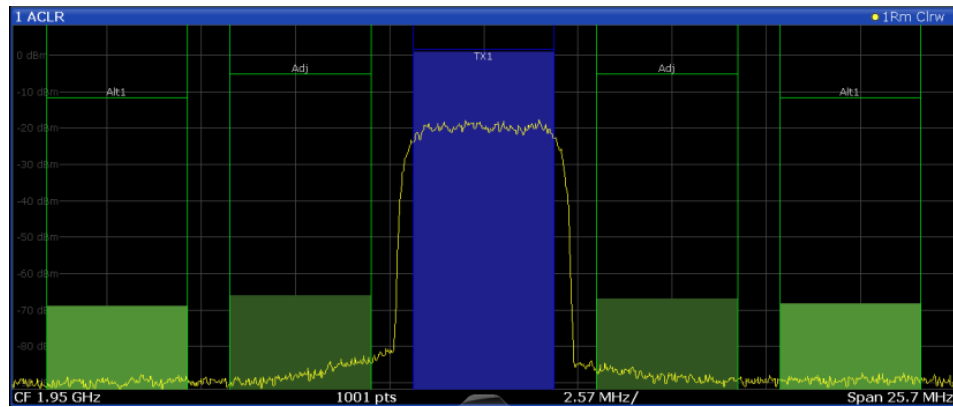

SCPI command:

LAY:ADD? '1',RIGH, DIAG, see LAYout:ADD[:WINDow]? on page 152

### Result Summary

Result summaries provide the results of specific measurement functions in a table for numerical evaluation. The contents of the result summary vary depending on the selected measurement function. See the description of the individual measurement functions for details.

2 Result Summary				
Channel	Bandwidth	Offset	Power	
TX1 (Ref)	1.229 MHz		<b>-0.86 dBm</b>	
Tx Total			<b>-0.86 dBm</b>	
Channel	Bandwidth	Offset	Lower	Upper
Adj	30.000 kHz	750.000 kHz	<b>-79.59 dB</b>	<b>-80.34 dB</b>
Alt1	30.000 kHz	1.960 MHz	<b>-85.04 dB</b>	<b>-83.85 dB</b>

SCPI command:

LAY:ADD? '1',RIGH, RSUM, see LAYout:ADD[:WINDow]? on page 152

### Marker Table

Displays a table with the current marker values for the active markers.

2 Marker						
Type	Ref	Trc	Stimulus	Response	Function	Function Result
N1		1	13.197 GHz	-25.87 dBm	Count	13.19705
D1	N1	1	-7.942 GHz	-49.41 dB		
D2	N1	2	-3.918 GHz	-21.90 dB		
D3	N1	3	4.024 GHz	-21.99 dB		

SCPI command:

LAY:ADD? '1',RIGH, MTAB, see LAYout:ADD[:WINDow]? on page 152

### Marker Peak List

The marker peak list determines the frequencies and levels of peaks in the spectrum or time domain. How many peaks are displayed can be defined, as well as the sort order. In addition, the detected peaks can be indicated in the diagram. The peak list can also be exported to a file for analysis in an external application.

2 Marker Peak List		
No	Stimulus	Response
1	64.400000 MHz	-30.352 dBm
2	128.400000 MHz	-51.896 dBm
3	192.300000 MHz	-40.227 dBm
4	257.200000 MHz	-60.699 dBm
5	320.200000 MHz	-44.273 dBm
6	384.100000 MHz	-53.494 dBm
7	448.100000 MHz	-47.460 dBm
8	513.000000 MHz	-55.603 dBm

SCPI command:

LAY:ADD? '1',RIGH, PEAK, see LAYout:ADD[:WINDow]? on page 152

## 4 Measurement Basics

Some background knowledge on basic terms and principles used in WLAN measurements is provided here for a better understanding of the required configuration settings.

### 4.1 Signal Processing for the IEEE 802.11a Standard

This description gives a rough view of the signal processing when using the R&S FSW WLAN application with the IEEE 802.11a standard. Details are disregarded in order to provide a concept overview.

#### Abbreviations

$a_{l,k}$	symbol at symbol $l$ of subcarrier $k$
$EVM_k$	error vector magnitude of subcarrier $k$
EVM	error vector magnitude of current packet
$g$	signal gain
$\Delta f$	frequency deviation between TX and RX
$l$	symbol index $l = \{1 \dots \text{nof\_Symbols}\}$
nof_symbols	number of symbols of payload
$H_k$	channel transfer function of subcarrier $k$
$k$	channel index $k = \{-31 \dots 32\}$
$K_{\text{mod}}$	modulation-dependent normalization factor
$\xi$	relative clock error of reference oscillator
$r_{l,k}$	subcarrier of symbol $l$

- [Block Diagram Using the IEEE 802.11a Standard](#).....35
- [Literature to the IEEE 802.11a Application](#).....42

#### 4.1.1 Block Diagram Using the IEEE 802.11a Standard

A diagram of the interesting blocks when using the IEEE 802.11a standard in the R&S FSW WLAN application is shown in [figure 4-1](#).

First the RF signal is downconverted to the IF frequency  $f_{IF}$ . The resulting IF signal  $r_{IF}(t)$  is shown on the left-hand side of the figure. After bandpass filtering, the signal is sampled by an analog to digital converter (ADC) at a sampling rate of  $f_{s1}$ . This digital sequence is resampled. Thus, the sampling rate of the downsampled sequence  $r(i)$  is the Nyquist rate of  $f_{s3} = 20$  MHz. Up to this point the digital part is implemented in an ASIC.

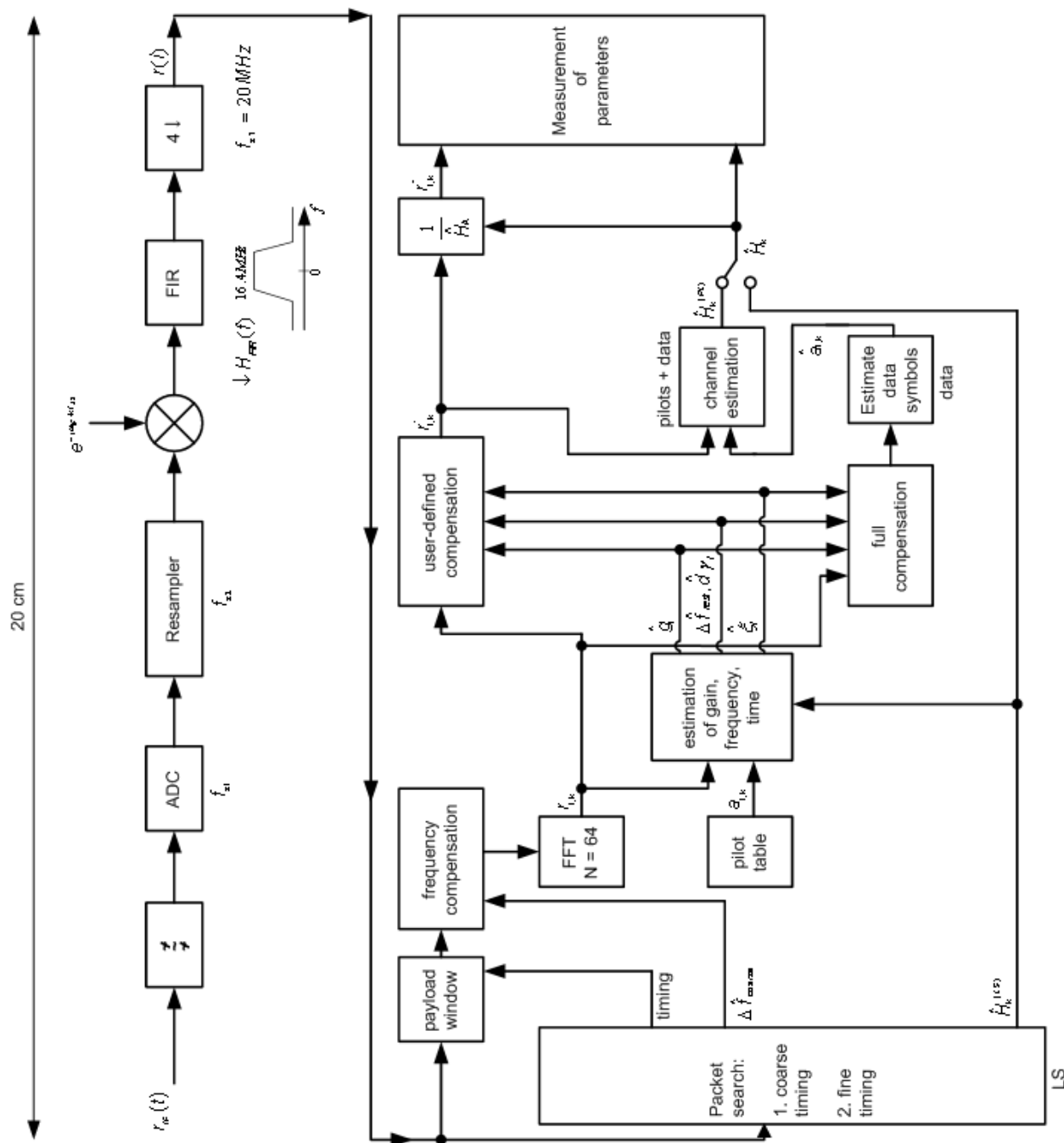

Fig. 4-1: Block diagram for the R&S FSW WLAN application using the IEEE 802.11a standard

In the lower part of the figure the subsequent digital signal processing is shown.

**Packet search and timing detection**

In the first block the **packet search** is performed. This block detects the *long symbol* (LS) and recovers the timing. The **coarse timing** is detected first. This search is implemented in the time domain. The algorithm is based on cyclic repetition within the LS after  $N = 64$  samples. Numerous treatises exist on this subject, e.g. [1] to [3].

Furthermore, a coarse estimate  $\Delta\hat{f}_{\text{coarse}}$  of the Rx-Tx frequency offset  $\Delta f$  is derived from the metric in [6]. (The hat generally indicates an estimate, e.g.  $\hat{x}$  is the estimate of  $x$ .) This can easily be understood because the phase of  $r(i) \cdot \Delta r^*(i + N)$  is determined by the frequency offset. As the frequency deviation  $\Delta f$  can exceed half a bin (distance between neighboring sub-carriers) the preceding *short symbol* (SS) is also analyzed in order to detect the ambiguity.

After the coarse timing calculation the time estimate is improved by the **fine timing** calculation. This is achieved by first estimating the coarse frequency response  $\hat{H}_k^{(LS)}$ , where  $k = \{-26..26\}$  denotes the channel index of the *occupied* sub-carriers. First the FFT of the LS is calculated. After the FFT calculation the known symbol information of the LS sub-carriers is removed by dividing by the symbols. The result is a coarse estimate  $\hat{H}_k$  of the channel transfer function. In the next step, the complex channel impulse response is computed by an IFFT. Then the energy of the windowed impulse response (the window size is equal to the guard period) is calculated for each trial time. Afterwards the trial time of the maximum energy is detected. This trial time is used to adjust the timing.

### Determining the payload window

Now the position of the LS is known and the starting point of the useful part of the first payload symbol can be derived. In the next block this calculated time instant is used to position the **payload window**. Only the payload part is windowed. This is sufficient because the payload is the only subject of the subsequent measurements.

In the next block the windowed sequence is **compensated** by the coarse frequency estimate  $\Delta\hat{f}_{\text{coarse}}$ . This is necessary because otherwise inter-channel interference (ICI) would occur in the frequency domain.

The transition to the frequency domain is achieved by an FFT of length 64. The FFT is performed symbol-wise for each symbol of the payload ("nof\_symbols"). The calculated FFTs are described by  $r_{l,k}$  with:

- $l = \{1 .. \text{nof\_symbols}\}$  as the symbol index
- $k = \{-31 .. 32\}$  as the channel index

In case of an additive white Gaussian noise (AWGN) channel, the FFT is described by [4], [5]

$$r_{l,k} = K_{\text{mod}} \times a_{l,k} \times g_l \times H_k \times e^{j(\text{phase}_l^{(\text{common})} + \text{phase}_{l,k}^{(\text{timing})})} + n_{l,k}$$

FFT (4 - 1)

with:

- $K_{\text{mod}}$ : the modulation-dependant normalization factor
- $a_{l,k}$ : the symbol of sub-carrier  $k$  at symbol  $l$
- $g_l$ : the gain at the symbol  $l$  in relation to the reference gain  $g = 1$  at the long symbol (LS)
- $H_k$ : the channel frequency response at the long symbol (LS)
- $\text{phase}_l^{(\text{common})}$ : the common phase drift phase of all sub-carriers at symbol  $l$  (see [Common phase drift](#))

- $\text{phase}_{l,k}^{(\text{timing})}$ : the phase of sub-carrier k at symbol l caused by the timing drift (see [Common phase drift](#))
- $n_{l,k}$ : the independent Gaussian distributed noise samples

### Phase drift and frequency deviation

The common phase drift in [FFT](#) is given by:

$$\text{phase}_l^{(\text{common})} = 2\pi \times N_s / N \times \Delta f_{\text{rest}} T \times l + d\gamma_l$$

Common phase drift (4 - 2)

with

- $N_s = 80$ : the number of Nyquist samples of the symbol period
- $N = 64$ : the number of Nyquist samples of the useful part of the symbol
- $\Delta f_{\text{rest}}$ : the (not yet compensated) frequency deviation
- $d\gamma_l$ : the phase jitter at the symbol l

In general, the coarse frequency estimate  $\Delta \hat{f}_{\text{coarse}}$  (see [figure 4-1](#)) is not error-free. Therefore the remaining frequency error  $\Delta f_{\text{rest}}$  represents the frequency deviation in  $r_{l,k}$  not yet compensated. Consequently, the overall frequency deviation of the device under test (DUT) is calculated by:

$$\Delta f = \Delta \hat{f}_{\text{coarse}} + \Delta f_{\text{rest}}$$



The common phase drift in [Common phase drift](#) is divided into two parts to calculate the overall frequency deviation of the DUT.

The reason for the phase jitter  $d\gamma_l$  in [Common phase drift](#) may be different. The nonlinear part of the phase jitter may be caused by the phase noise of the DUT oscillator. Another reason for nonlinear phase jitter may be the increase of the DUT amplifier temperature at the beginning of the PPDU. Note that besides the nonlinear part the phase jitter,  $d\gamma_l$  also contains a constant part. This constant part is caused by the frequency deviation  $\Delta f_{\text{rest}}$  not yet compensated. To understand this, keep in mind that the measurement of the phase starts at the first symbol  $l = 1$  of the payload. In contrast, the channel frequency response  $H_k$  in [FFT](#) represents the channel at the long symbol of the preamble. Consequently, the frequency deviation  $\Delta f_{\text{rest}}$  not yet compensated produces a phase drift between the long symbol and the first symbol of the payload. Therefore, this phase drift appears as a constant value ("DC value") in  $d\gamma_l$ .

### Tracking the phase drift, timing jitter and gain

Referring to the IEEE 802.11a measurement standard, chapter 17.3.9.7 "Transmit modulation accuracy test" [6], the common phase drift  $\text{phase}_l^{(\text{common})}$  must be estimated and compensated from the pilots. Therefore this "symbol-wise phase tracking" is activated as the default setting of the R&S FSW WLAN application (see ["Phase Tracking"](#) on page 75).

Furthermore, the timing drift in [FFT](#) is given by:

$$phase_{l,k}^{(\text{timing})} = 2\pi \times N_s / N \times \xi \times k \times l$$

Timing drift (4 - 3)

with  $\xi$ : the relative clock deviation of the reference oscillator

Normally, a symbol-wise timing jitter is negligible and thus not modeled in [Timing drift](#). However, there may be situations where the timing drift has to be taken into account. This is illustrated by an example: In accordance to [6], the allowed clock deviation of the DUT is up to  $\xi_{\text{max}} = 20$  ppm. Furthermore, a long packet with 400 symbols is assumed. The result of [FFT](#) and [Timing drift](#) is that the phase drift of the highest sub-carrier  $k = 26$  in the last symbol  $l = \text{nof\_symbols}$  is 93 degrees. Even in the noise-free case, this would lead to symbol errors. The example shows that it is actually necessary to estimate and compensate the clock deviation, which is accomplished in the next block.

Referring to the IEEE 802.11a measurement standard [6], the timing drift  $phase_{l,k}^{(\text{timing})}$  is not part of the requirements. Therefore the "time tracking" is not activated as the default setting of the R&S FSW WLAN application (see ["Timing Error Tracking"](#) on page 75). The time tracking option should rather be seen as a powerful analyzing option.

In addition, the tracking of the gain  $g_l$  in [FFT](#) is supported for each symbol in relation to the reference gain  $g = 1$  at the time instant of the long symbol (LS). At this time the coarse channel transfer function  $\hat{H}^{(\text{LS})}_k$  is calculated.

This makes sense since the sequence  $r'_{l,k}$  is compensated by the coarse channel transfer function  $\hat{H}^{(\text{LS})}_k$  before estimating the symbols. Consequently, a potential change of the gain at the symbol  $l$  (caused, for example, by the increase of the DUT amplifier temperature) may lead to symbol errors especially for a large symbol alphabet  $M$  of the MQAM transmission. In this case, the estimation and the subsequent compensation of the gain are useful.

Referring to the IEEE 802.11a measurement standard [6], the compensation of the gain  $g_l$  is not part of the requirements. Therefore the "gain tracking" is not activated as the default setting of the R&S FSW WLAN application (see [".Level Error \(Gain\) Tracking"](#) on page 75).

### Determining the error parameters (log likelihood function)

How can the parameters above be calculated? In this application the optimum maximum likelihood algorithm is used. In the first estimation step the symbol-independent parameters  $\Delta f_{\text{rest}}$  and  $\xi$  are estimated. The symbol dependent parameters can be neglected in this step, i.e. the parameters are set to  $g_l = 1$  and  $dy = 0$ . Referring to [FFT](#), the log likelihood function  $L$  must be calculated as a function of the trial parameters  $\Delta \tilde{f}_{\text{rest}}$  and  $\tilde{\xi}$ . (The tilde generally describes a trial parameter. Example:  $\tilde{x}$  is the trial parameter of  $x$ .)

$$L_1(\Delta\tilde{f}_{rest}, \tilde{\xi}) = \sum_{l=1}^{nof\_symbols} \sum_{k=-21,-7,7,21} \left| r_{l,k} - a_{l,k} \times \hat{H}_k^{(LS)} \times e^{j(\tilde{p}hase_l^{(common)} + \tilde{p}hase_l^{(i\ min\ g)})} \right|^2$$

with

$$\tilde{p}hase_l^{(common)} = 2\pi \times N_s / N \times \Delta\tilde{f}_{rest} T \times l$$

$$\tilde{p}hase_l^{(i\ min\ g)} = 2\pi \times N_s / N \times \tilde{\xi} \times k \times l$$

Log likelihood function (step 1) (4 - 4)

The trial parameters leading to the minimum of the log likelihood function are used as estimates  $\Delta\hat{f}_{rest}$  and  $\hat{\xi}$ . In [Log likelihood function \(step 1\)](#) the known pilot symbols  $a_{l,k}$  are read from a table.

In the second step, the log likelihood function is calculated for every symbol  $l$  as a function of the trial parameters  $\tilde{g}_l$  and  $d\tilde{\gamma}_l$ :

$$L_2(\tilde{g}_l, d\tilde{\gamma}_l) = \sum_{k=-21,-7,7,21} \left| r_{l,k} - a_{l,k} \times \tilde{g}_l \times \hat{H}_k^{(LS)} \times e^{j(\tilde{p}hase_l^{(common)} + \tilde{p}hase_l^{(i\ min\ g)})} \right|^2$$

with

$$\tilde{p}hase_l^{(common)} = 2\pi \times N_s / N \times \Delta\hat{f}_{rest} T \times l + d\tilde{\gamma}_l$$

$$\tilde{p}hase_l^{(i\ min\ g)} = 2\pi \times N_s / N \times \hat{\xi} \times k \times l$$

Log likelihood function (step 2) (4 - 5)

Finally, the trial parameters leading to the minimum of the log likelihood function are used as estimates  $\hat{g}_l$  and  $d\hat{\gamma}_l$ .

This robust algorithm works well even at low signal to noise ratios with the Cramer Rao Bound being reached.

### Compensation

After estimation of the parameters, the sequence  $r_{l,k}$  is compensated in the compensation blocks.

In the upper analyzing branch the compensation is user-defined i.e. the user determines which of the parameters are compensated. This is useful in order to extract the influence of these parameters. The resulting output sequence is described by:  $\hat{y}_{\delta,k}$ .

### Data symbol estimation

In the lower compensation branch the full compensation is always performed. This separate compensation is necessary in order to avoid symbol errors. After the full compensation the secure estimation of the data symbols  $\hat{a}_{l,k}$  is performed. From [FFT](#) it is clear that first the channel transfer function  $H_k$  must be removed. This is achieved by dividing the known coarse channel estimate  $\hat{H}_k^{(LS)}$  calculated from the LS. Usually an error free estimation of the data symbols can be assumed.



### Improving the channel estimation

In the next block a better channel estimate  $\hat{H}^{(PL)}_k$  of the data and pilot sub-carriers is calculated by using all "nof\_symbols" symbols of the payload (PL). This can be accomplished at this point because the phase is compensated and the data symbols are known. The long observation interval of nof\_symbols symbols (compared to the short interval of 2 symbols for the estimation of  $\hat{H}^{(LS)}_k$ ) leads to a nearly error-free channel estimate.

In the following equalizer block,  $\hat{H}^{(LS)}_k$  is compensated by the channel estimate. The resulting channel-compensated sequence is described by  $y_{\delta,k}$ . The user may either choose the coarse channel estimate  $\hat{H}^{(LS)}_k$  (from the long symbol) or the nearly error-free channel estimate  $\hat{H}^{(PL)}_k$  (from the payload) for equalization. If the improved estimate  $\hat{H}^{(LS)}_k$  is used, a 2 dB reduction of the subsequent EVM measurement can be expected.

According to the IEEE 802.11a measurement standard [6], the coarse channel estimation  $\hat{H}^{(LS)}_k$  (from the long symbol) has to be used for equalization. Therefore the default setting of the R&S FSW WLAN application is equalization from the coarse channel estimate derived from the long symbol.

### Calculating error parameters

In the last block the parameters of the demodulated signal are calculated. The most important parameter is the error vector magnitude of the sub-carrier "k" of the current packet:

$$\overline{EVM} = \sqrt{\frac{1}{\text{nof\_packets}} \sum_{\text{counter}=1}^{\text{nof\_packets}} EVM^2(\text{counter})}$$

Error vector magnitude of the subcarrier k in current packet (4 - 6)

Furthermore, the packet error vector magnitude is derived by averaging the squared  $EVM_k$  versus k:

$$EVM = \sqrt{\frac{1}{52} \sum_{k=-26(k \neq 0)}^{26} EVM_k^2}$$

Error vector magnitude of the entire packet (4 - 7)

Finally, the average error vector magnitude is calculated by averaging the packet EVM of all nof\_symbols detected packets:

$$EVM_k = \sqrt{\frac{1}{\text{nof\_symbols}} \sum_{l=1}^{\text{nof\_symbols}} |r_{l,k} - K_{\text{mod}} \times a_{l,k}|^2}$$

Average error vector magnitude (4 - 8)

This parameter is equivalent to the "RMS average of all errors":  $\text{Error}_{\text{RMS}}$  of the IEEE 802.11a measurement commandment (see [6]).

### 4.1.2 Literature to the IEEE 802.11a Application

[1]	Speth, Classen, Meyr: "Frame synchronization of OFDM systems in frequency selective fading channels", VTC '97, pp. 1807-1811
[2]	Schmidl, Cox: "Robust Frequency and Timing Synchronization of OFDM", IEEE Trans. on Comm., Dec. 1997, pp. 1613-621
[3]	Minn, Zeng, Bhargava: "On Timing Offset Estimation for OFDM", IEEE Communication Letters, July 2000, pp. 242-244
[4]	Speth, Fechtel, Fock, Meyr: "Optimum Receiver Design for Wireless Broad-Band Systems Using OFDM – Part I", IEEE Trans. On Comm. VOL. 47, NO 11, Nov. 1999
[5]	Speth, Fechtel, Fock, Meyr: "Optimum Receiver Design for Wireless Broad-Band Systems Using OFDM – Part II", IEEE Trans. On Comm. VOL. 49, NO 4, April. 2001
[6]	IEEE 802.11a, Part 11: WLAN Medium Access Control (MAC) and Physical Layer (PHY) specifications

## 4.2 Physical vs Effective Channels

The data transmitted between a sender and the recipient is referred to as a *space-time stream*. Space-time streams contain the coded data that is to be transmitted. (The transmitted, demodulated and decoded data is referred to as a *bitstream*.) In order to transmit the data, one or more antennas are required by the sender, and one or more antennas are required by the receiver.

For each space-time stream, at least one training field is included in every PPDU preamble. Each sender antenna transmits these known training fields. The space-time streams are then mapped to the receiver antennas. The mapping of a space-time stream to a receiver antenna is also referred to as an *effective channel*.

If the spatial mapping is known and the channel matrix is invertible, the mapping of the receiver antenna to the sender antenna for a space-time stream can be determined. This mapping is referred to as a *physical channel*.

While the physical channels cannot always be determined, the effective channel can always be estimated from the known training fields. Thus, for some PPDUs or measurement scenarios, only the results based on the mapping of the space-time stream to the Rx antenna (effective channel) are available, as the mapping of the Rx antennas to the Tx antennas (physical channel) could not be determined.

If the physical channels can be determined, the R&S FSW WLAN application can provide spectral results (channel flatness, group delay, channel phase, channel impulse response and channel singular values) for the physical (Tx and Receiver) channels and the effective channel (stream).

### Channels and carriers

In an OFDM system such as WLAN, the channel is divided into carriers using FFT / IFFT. Depending on the channel bandwidth, the FFT window varies between 64 and 512 (see also [chapter 4.4, "Demodulation Parameters - Logical Filters"](#), on page 43). Some of these carriers can be used (active carriers), others are inactive (e.g. guard carriers at the

edges). The channel can then be determined using the active carriers as known points; inactive carriers are interpolated.

### Channel Display in the Spectrum Analyzer

In the R&S FSW WLAN application, channels are represented by their transmission spectrum, i.e. the gains of the active carriers. In effect, a *physical channel* represents the transmission spectrum sent by a particular sender and received by a particular receiver antenna. An *effective channel*, on the other hand, represents the transmission spectrum of a specific space-time stream received by a particular receiver antenna.

## 4.3 Recognized vs. Analyzed PPDU

A PPDU in a WLAN signal consists of the following parts:

- **Preamble**  
Information required to recognize the PPDU within the signal
- **Signal Field**  
Information on the modulation used for transmission of the useful data
- **Payload**  
The useful data

During signal processing, PPDU are recognized by their preamble symbols. The recognized PPDU and the information on the modulation used for transmission of the useful data are shown in the "Signal Field" result display (see ["Signal Field"](#) on page 24).

Not all of the recognized PPDU must be analyzed. Some are dismissed because the PPDU parameters do not match the user-defined demodulation settings, which act as a *logical filter* (see also [chapter 4.4, "Demodulation Parameters - Logical Filters"](#), on page 43). Others may be dismissed because they contain too many or too few payload symbols (as defined by the standard), or due to other irregularities or inconsistency. Dismissed PPDU are indicated as such in the "Signal Field" result display. Only the remaining, *valid* PPDU are actually analyzed. The PPDU to be analyzed are highlighted in the "Magnitude Capture" buffer display.

Then again, the *physical channel* cannot always be determined for all analyzed PPDU. In this case, results are only available for the *effective channel* (see also [chapter 4.2, "Physical vs Effective Channels"](#), on page 42).

## 4.4 Demodulation Parameters - Logical Filters

The demodulation settings define which PPDU are to be analyzed, thus they define a *logical filter*. They can either be defined using specific values or according to the first measured PPDU.

Which of the WLAN demodulation parameter values are supported depends on the selected digital standard, some are also interdependent.

**Table 4-1: Supported modulation formats, PPDU formats and channel bandwidths depending on standard**

Standard	Modulation formats	PPDU formats	Channel bandwidths
IEEE 802.11a	BPSK (6 & 9 Mbps) QPSK (12 & 18 Mbps) 16QAM (24 & 36 Mbps) 64QAM (48 & 54 Mbps)	HT	5 MHz, 10 MHz, 20 MHz <sup>*)</sup>
IEEE 802.11n	<b>SISO:</b> BPSK (6.5, 7.2, 13.5 & 15 Mbps) QPSK (13, 14.4, 19.5, 21.7, 27, 30, 40.5 & 45 Mbps) 16QAM (26, 28.9, 39, 43.3, 54, 60, 81 & 90 Mbps) 64QAM (52, 57.8, 58.5, 65, 72.2, 108, 121.5, 135, 120, 135 & 150 Mbps) <b>MIMO:</b> depends on the MCS index	HT-MF (Mixed format) HT-GF (Greenfield format)	20 MHz <sup>*)</sup> , 40 MHz <sup>*)</sup>
IEEE 802.11ac	16QAM 64QAM 256QAM	VHT	20 MHz <sup>*)</sup> , 40 MHz <sup>*)</sup> , 80 MHz <sup>*)</sup> , 160 MHz <sup>*)</sup>

<sup>\*)</sup>: requires R&S FSW bandwidth extension option, see [chapter A.1, "Sample Rate and Maximum Usable I/Q Bandwidth for RF Input"](#), on page 201

## 4.5 Receiving Data Input and Providing Data Output

The R&S FSW can analyze signals from different input sources and provide various types of output (such as noise or trigger signals).



Digital Baseband output is only available in the I/Q Analyzer application, and only if the optional Digital Baseband Interface (R&S FSW-B17) is installed.

For details see the R&S FSW I/Q Analyzer User Manual.

### 4.5.1 RF Input Protection

The RF input connector of the R&S FSW must be protected against signal levels that exceed the ranges specified in the data sheet. Therefore, the R&S FSW is equipped with an overload protection mechanism. This mechanism becomes active as soon as the power at the input mixer exceeds the specified limit. It ensures that the connection between RF input and input mixer is cut off.

When the overload protection is activated, an error message is displayed in the status bar ("INPUT OVLD"), and a message box informs you that the RF Input was disconnected.

ted. Furthermore, a status bit (bit 3) in the `STAT:QUES:POW` status register is set. In this case you must decrease the level at the RF input connector and then close the message box. Then measurement is possible again. Reactivating the RF input is also possible via the remote command `INPut:ATTenuation:PROTection:RESet` .

## 4.5.2 Importing and Exporting I/Q Data

Baseband signals mostly occur as so-called complex baseband signals, i.e. a signal representation that consists of two channels; the in phase (I) and the quadrature (Q) channel. Such signals are referred to as I/Q signals. I/Q signals are useful because the specific RF or IF frequencies are not needed. The complete modulation information and even distortion that originates from the RF, IF or baseband domains can be analyzed in the I/Q baseband.

Importing and exporting I/Q signals is useful for various applications:

- Generating and saving I/Q signals in an RF or baseband signal generator or in external software tools to analyze them with the R&S FSW later
- Capturing and saving I/Q signals with an RF or baseband signal analyzer to analyze them with the R&S FSW or an external software tool later

For example, you can capture I/Q data using the I/Q Analyzer application and then perform vector signal analysis on that data using the R&S FSW VSA application, if available.

As opposed to storing trace data, which may be averaged or restricted to peak values, I/Q data is stored as it was captured, without further processing. The data is stored as complex values in 32-bit floating-point format. Multi-channel data is not supported. The I/Q data is stored in a format with the file extension `.iq.tar`. For a detailed description see [chapter A.2, "Reference: I/Q Data File Export Format \(iq.tar\)"](#), on page 203.

## 4.5.3 Input from Noise Sources

The R&S FSW provides a connector (NOISE SOURCE CONTROL) with a voltage supply for an external noise source. By switching the supply voltage for an external noise source on or off in the firmware, you can activate or deactivate the device as required.

External noise sources are useful when you are measuring power levels that fall below the noise floor of the R&S FSW itself, for example when measuring the noise level of an amplifier.

In this case, you can first connect an external noise source (whose noise power level is known in advance) to the R&S FSW and measure the total noise power. From this value you can determine the noise power of the R&S FSW. Then when you measure the power level of the actual DUT, you can deduct the known noise level from the total power to obtain the power level of the DUT.

The noise source is controlled in the "Output" settings, see ["Noise Source"](#) on page 59

#### 4.5.4 Receiving and Providing Trigger Signals

Using one of the variable TRIGGER INPUT/OUTPUT connectors of the R&S FSW, the R&S FSW can use a signal from an external reference as a trigger to capture data. Alternatively, the internal trigger signal used by the R&S FSW can be output for use by other connected devices. Using the same trigger on several devices is useful to synchronize the transmitted and received signals within a measurement.

For details on the connectors see the R&S FSW "Getting Started" manual.

##### External trigger as input

If the trigger signal for the R&S FSW is provided by an external reference, the reference signal source must be connected to the R&S FSW and the trigger source must be defined as "External" on the R&S FSW.

##### Trigger output

The R&S FSW can send output to another device either to pass on the internal trigger signal, or to indicate that the R&S FSW itself is ready to trigger.

The trigger signal can be output by the R&S FSW automatically, or manually by the user. If it is sent automatically, a high signal is output when the R&S FSW has triggered due to a sweep start ("Device Triggered"), or when the R&S FSW is ready to receive a trigger signal after a sweep start ("Trigger Armed").

##### Manual triggering

If the trigger output signal is initiated manually, the length and level (high/low) of the trigger pulse is also user-definable. Note, however, that the trigger pulse level is always opposite to the constant signal level defined by the output "Level" setting, e.g. for "Level = High", a constant high signal is output to the connector until the "Send Trigger" button is selected. Then, a low pulse is sent.



Providing trigger signals as output is described in detail in the R&S FSW User Manual.

---

## 4.6 Preparing the R&S FSW for the Expected Input Signal - Frontend Parameters

On the R&S FSW, the input data can only be processed optimally if the hardware settings match the signal characteristics as closely as possible. On the other hand, the hardware must be protected from powers or frequencies that exceed the allowed limits. Therefore, you must set the hardware so that it is optimally prepared for the expected input signal, without being overloaded. You do this using the *frontend* parameters. Consider the following recommendations:

**Reference level**

Adapt the R&S FSW's hardware to the expected maximum signal level by setting the "Reference Level" to this maximum. Compensate for any external attenuation or gain into consideration by defining a "Reference Level" offset.

**Attenuation**

To optimize the signal-to-noise ratio of the measurement for high signal levels and to protect the R&S FSW from hardware damage, provide for a high attenuation. Use AC coupling for DC input voltage.

**Amplification**

To optimize the signal-to-noise ratio of the measurement for low signal levels, the signal level in the R&S FSW should be as high as possible but without introducing compression, clipping, or overload. Provide for early amplification by the preamplifier and a low attenuation.

**Impedance**

When measuring in a 75  $\Omega$  system, connect an external matching pad to the RF input and adapt the reference impedance for power results. The insertion loss is compensated for numerically.

## 4.7 Triggered measurements

In a basic sweep measurement with default settings, the sweep is started immediately when you start the measurement, for example by pressing the RUN SINGLE key. However, sometimes you want the measurement to start only when a specific condition is fulfilled, for example a signal level is exceeded, or in certain time intervals. For these cases you can define a trigger for the measurement. In FFT sweep mode, the trigger defines when the data acquisition starts for the FFT conversion.

An "Offset" can be defined to delay the measurement after the trigger event, or to include data before the actual trigger event in time domain measurements (pre-trigger offset).

For complex tasks, advanced trigger settings are available:

- Hysteresis to avoid unwanted trigger events caused by noise
- Holdoff to define exactly which trigger event will cause the trigger in a jittering signal

4.7.1	Trigger Offset.....	48
4.7.2	Trigger Hysteresis.....	48
4.7.3	Trigger Drop-Out Time.....	48
4.7.4	Trigger Holdoff.....	49

### 4.7.1 Trigger Offset

An offset can be defined to delay the measurement after the trigger event, or to include data before the actual trigger event in time domain measurements (pre-trigger offset). Pre-trigger offsets are possible because the R&S FSW captures data continuously in the time domain, even before the trigger occurs.

See "[Trigger Offset](#)" on page 71.

### 4.7.2 Trigger Hysteresis

Setting a hysteresis for the trigger helps avoid unwanted trigger events caused by noise, for example. The hysteresis is a threshold to the trigger level that the signal must fall below on a rising slope or rise above on a falling slope before another trigger event occurs.

#### Example:

In the following example, the second possible trigger event is ignored as the signal does not exceed the hysteresis (threshold) before it reaches the trigger level again on the rising edge. On the falling edge, however, two trigger events occur as the signal exceeds the hysteresis before it falls to the trigger level the second time.

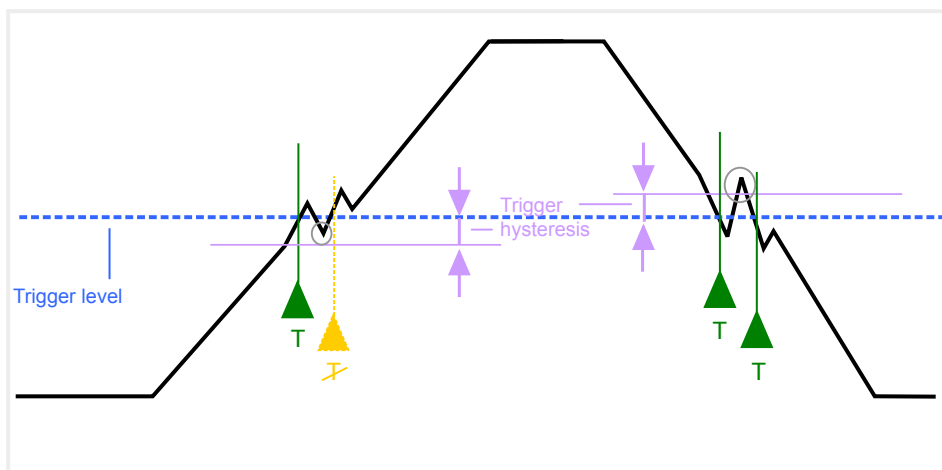

*Fig. 4-2: Effects of the trigger hysteresis*

See "[Hysteresis](#)" on page 71

### 4.7.3 Trigger Drop-Out Time

If a modulated signal is instable and produces occasional "drop-outs" during a burst, you can define a minimum duration that the input signal must stay below the trigger level before triggering again. This is called the "drop-out" time. Defining a dropout time helps you stabilize triggering when the analyzer is triggering on undesired events.



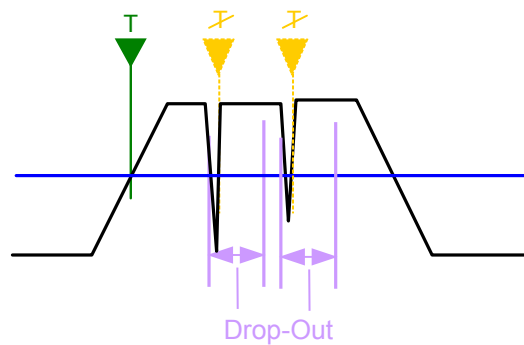

Fig. 4-3: Effect of the trigger drop-out time

See "Drop-Out Time" on page 71.

#### 4.7.4 Trigger Holdoff

The trigger holdoff defines a waiting period before the next trigger after the current one will be recognized.

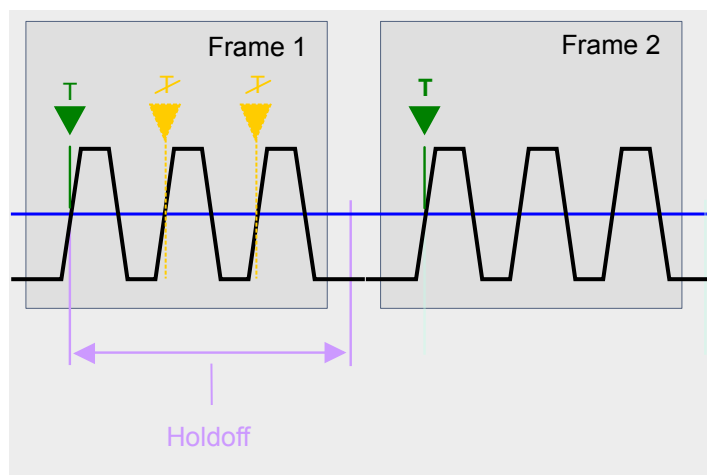

Fig. 4-4: Effect of the trigger holdoff

See "Trigger Holdoff" on page 72.

## 5 Configuration

The default WLAN measurement captures the I/Q data from the WLAN signal and determines various characteristic signal parameters such as the modulation accuracy, spectrum flatness, center frequency tolerance and symbol clock tolerance in just one measurement (see [chapter 3.1, "Default WLAN Measurement \(Modulation Accuracy, Flatness and Tolerance\)"](#), on page 11)

Other parameters specified in the WLAN 802.11 standard must be determined in separate measurements (see [chapter 5.4, "RF \(Frequency Domain\) Measurements"](#), on page 89).

In settings required to configure each of these measurements are described here.

### Selecting the measurement type

- ▶ To select a different measurement type, do one of the following:
  - Tap the "Overview" softkey. In the "Overview", tap the "Select Measurement" button. Select the required measurement.
  - Press the MEAS key on the front panel. In the "Select Measurement" dialog box, select the required measurement.

• <a href="#">Multiple Measurement Channels and Sequencer Function</a> .....	50
• <a href="#">Display Configuration</a> .....	52
• <a href="#">Default WLAN Measurement (Modulation Accuracy, Flatness, Tolerance...)</a> .....	52
• <a href="#">RF (Frequency Domain) Measurements</a> .....	89

### 5.1 Multiple Measurement Channels and Sequencer Function

When you activate an application, a new measurement channel is created which determines the measurement settings for that application. These settings include the input source, the type of data to be processed (I/Q or RF data), frequency and level settings, measurement functions etc. If you want to perform the same measurement but with different center frequencies, for instance, or process the same input data with different measurement functions, there are two ways to do so:

- Change the settings in the measurement channel for each measurement scenario. In this case the results of each measurement are updated each time you change the settings and you cannot compare them or analyze them together without storing them on an external medium.
- Activate a new measurement channel for the same application. In the latter case, the two measurement scenarios with their different settings are displayed simultaneously in separate tabs, and you can either switch between the tabs or select the "MultiView" tab to compare the results.

For example, you can activate one WLAN measurement channel to perform a WLAN modulation accuracy measurement, and a second channel to perform an SEM measurement using the same WLAN input source.

The number of channels that can be configured at the same time depends on the available memory on the instrument.

Only one measurement can be performed on the R&S FSW at any time. If one measurement is running and you start another, or switch to another channel, the first measurement is stopped. In order to perform the different measurements you configured in multiple channels, you must switch from one tab to another.

However, you can enable a Sequencer function that automatically calls up each activated measurement channel in turn. This means the measurements configured in the channels are performed one after the other in the order of the tabs. The currently active measurement is indicated by a  symbol in the tab label. The result displays of the individual channels are updated in the corresponding tab (as well as the "MultiView") as the measurements are performed. Sequencer operation is independent of the currently *displayed* tab; for example, you can analyze the SEM measurement while the modulation accuracy measurement is being performed by the Sequencer.

For details on the Sequencer function see the R&S FSW User Manual.

The Sequencer functions are only available in the "MultiView" tab.

Sequencer State.....	51
Sequencer Mode.....	51

### Sequencer State

Activates or deactivates the Sequencer. If activated, sequential operation according to the selected Sequencer mode is started immediately.

SCPI command:

`SYSTem:SEQuencer` on page 163

`INITiate:SEQuencer:IMMediate` on page 162

`INITiate:SEQuencer:ABORt` on page 162

### Sequencer Mode

Defines how often which measurements are performed. The currently selected mode softkey is highlighted blue. During an active Sequencer process, the selected mode softkey is highlighted orange.

"Single Sequencer"

Each measurement is performed once, until all measurements in all active channels have been performed.

"Continuous Sequencer"

The measurements in each active channel are performed one after the other, repeatedly, in the same order, until sequential operation is stopped.

This is the default Sequencer mode.

"Channel-defined Sequencer"

First, a single sequence is performed. Then, only channels in continuous sweep mode are repeated.

SCPI command:

`INITiate:SEQuencer:MODE` on page 162

## 5.2 Display Configuration

The measurement results can be displayed using various evaluation methods. All evaluation methods available for the R&S FSW WLAN application are displayed in the evaluation bar in SmartGrid mode when you do one of the following:

- Select the  "SmartGrid" icon from the toolbar.
- Select the "Display Config" button in the "Overview".
- Select the "Display Config" softkey in any WLAN menu.

Then you can drag one or more evaluations to the display area and configure the layout as required.

Up to 16 evaluation methods can be displayed simultaneously in separate windows. The WLAN evaluation methods are described in [chapter 3, "Measurements and Result Displays"](#), on page 11.

To close the SmartGrid mode and restore the previous softkey menu select the  "Close" icon in the righthand corner of the toolbar, or press any key on the front panel.



For details on working with the SmartGrid see the R&S FSW Getting Started manual.

---

## 5.3 Default WLAN Measurement (Modulation Accuracy, Flatness, Tolerance...)

When you activate the WLAN application, a default WLAN measurement of the input signal is started automatically with the default configuration. The "WLAN" menu is displayed and provides access to the most important configuration functions. This menu is also displayed when you press the MEAS CONFIG key on the front panel.



The "Span", "Bandwidth", "Lines", and "Marker Functions" menus are not available for default WLAN measurements.

---

WLAN measurements can be configured easily in the "Overview" dialog box, which is displayed when you select the "Overview" softkey from any menu.

• <a href="#">Default Settings for WLAN Measurements</a> .....	53
• <a href="#">Configuration Overview</a> .....	54
• <a href="#">Signal Description</a> .....	56
• <a href="#">Input and Frontend Settings</a> .....	56
• <a href="#">Signal Capture (Data Acquisition)</a> .....	65
• <a href="#">Synchronization and OFDM Demodulation</a> .....	73
• <a href="#">Tracking and Channel Estimation</a> .....	74
• <a href="#">Demodulation</a> .....	76
• <a href="#">Evaluation Range</a> .....	82
• <a href="#">Result Configuration</a> .....	84
• <a href="#">Automatic Settings</a> .....	85
• <a href="#">Sweep Settings</a> .....	87
• <a href="#">Import/Export Functions</a> .....	88

### 5.3.1 Default Settings for WLAN Measurements

When you activate the WLAN application the first time, a set of parameters is passed on from the currently active application:

- center frequency and frequency offset
- reference level and reference level offset
- attenuation
- input coupling
- YIG filter state

After initial setup, the parameters for the measurement channel are stored upon exiting and restored upon re-entering the channel. Thus, you can switch between applications quickly and easily.

Apart from the settings above, the following default settings are activated directly after the WLAN application is activated, or after selecting [Preset Channel](#):

**Table 5-1: Default settings for WLAN channels**

Parameter	Value
<b>Common WLAN settings</b>	
Digital standard	IEEE 802 11a
Measurement	Default WLAN measurement
Input source	RF input
Attenuation	10.0 dB
Capture time	1.0 ms
Input sample rate	40.0 MHz
Trigger mode	Free run
Channel estimation	Preamble
Tracking	Phase

## Default WLAN Measurement (Modulation Accuracy, Flatness, Tolerance...)

Parameter	Value
Pilot tracking	According to standard
PPDU format	Auto (same type as first PPDU)
Channel bandwidth to measure	Auto (same type as first PPDU)
MCS to use	Auto (same type as first PPDU)
Evaluations	Window 1: Magnitude Capture Window 2: Constellation

### 5.3.2 Configuration Overview



Throughout the measurement channel configuration, an overview of the most important currently defined settings is provided in the "Overview". The "Overview" is displayed when you select the "Overview" icon, which is available at the bottom of all softkey menus.

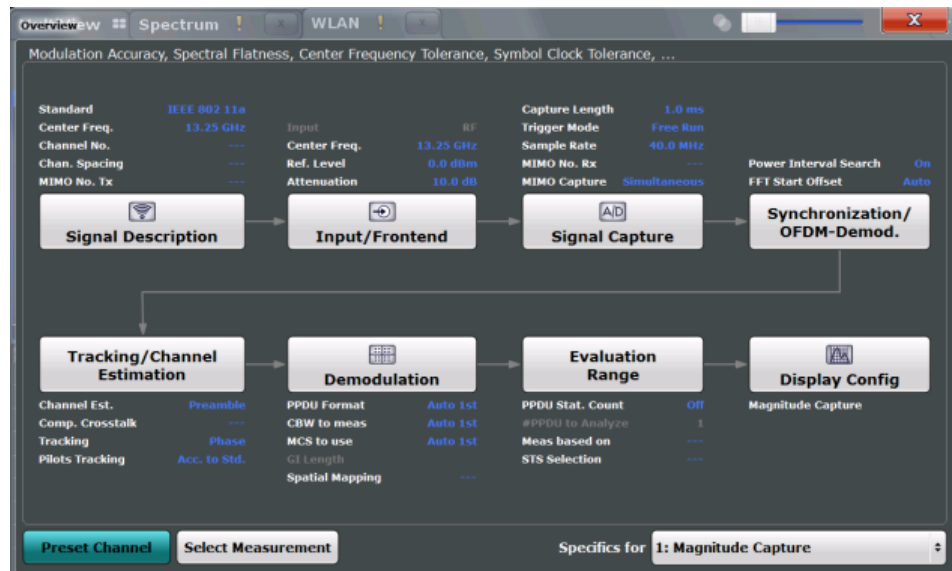

The "Overview" not only shows the main measurement settings, it also provides quick access to the main settings dialog boxes. The indicated signal flow shows which parameters affect which processing stage in the measurement. Thus, you can easily configure an entire measurement channel from input over processing to output and analysis by stepping through the dialog boxes as indicated in the "Overview".



The available settings and functions in the "Overview" vary depending on the currently selected measurement. For RF measurements (in the frequency domain) see [chapter 5.4, "RF \(Frequency Domain\) Measurements"](#), on page 89.

For the default WLAN measurement, the "Overview" provides quick access to the following configuration dialog boxes (listed in the recommended order of processing):

1. "Select Measurement"

## Default WLAN Measurement (Modulation Accuracy, Flatness, Tolerance...)

- See ["Selecting the measurement type"](#) on page 50
- 2. "Signal Description"  
See [chapter 5.3.3, "Signal Description"](#), on page 56
- 3. "Input/ Frontend"  
See and [chapter 5.3.4, "Input and Frontend Settings"](#), on page 56
- 4. "Signal Capture"  
See [chapter 5.3.5, "Signal Capture \(Data Acquisition\)"](#), on page 65
- 5. "Synchronization / OFDM demodulation"  
See [chapter 5.3.6, "Synchronization and OFDM Demodulation"](#), on page 73
- 6. "Tracking / Channel Estimation"  
See [chapter 5.3.7, "Tracking and Channel Estimation"](#), on page 74
- 7. "Demodulation"  
See [chapter 5.3.8, "Demodulation"](#), on page 76
- 8. "Evaluation Range"  
See [chapter 5.3.9, "Evaluation Range"](#), on page 82
- 9. "Display Configuration"  
See [chapter 5.2, "Display Configuration"](#), on page 52

**To configure settings**

- ▶ Select any button in the "Overview" to open the corresponding dialog box.  
Select a setting in the channel bar (at the top of the measurement channel tab) to change a specific setting.

**Preset Channel**

Select the "Preset Channel" button in the lower lefthand corner of the "Overview" to restore all measurement settings **in the current channel** to their default values.

Note that the PRESET key on the front panel restores all measurements **in all measurement channels** on the R&S FSW to their default values!

See [chapter 5.3.1, "Default Settings for WLAN Measurements"](#), on page 53 for details.

SCPI command:

`SYSTem:PRESet:CHANnel[:EXECute]` on page 107

**Select Measurement**

Selects a measurement to be performed.

See ["Selecting the measurement type"](#) on page 50.

**Specifics for**

The measurement channel may contain several windows for different results. Thus, the settings indicated in the "Overview" and configured in the dialog boxes vary depending on the selected window.

Select an active window from the "Specifics for" selection list that is displayed in the "Overview" and in all window-specific configuration dialog boxes.

The "Overview" and dialog boxes are updated to indicate the settings for the selected window.

### 5.3.3 Signal Description

The signal description provides information on the expected input signal.

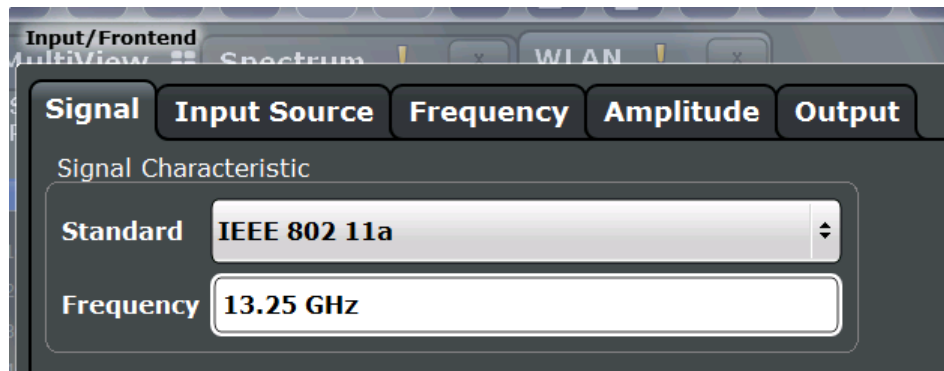

Standard.....56  
 Frequency.....56

#### Standard

Defines the WLAN standard. The measurements are performed according to the specified standard with the correct limit values and limit lines.

Many other WLAN measurement settings depend on the selected standard (see [chapter 4.4, "Demodulation Parameters - Logical Filters"](#), on page 43).

SCPI command:

`CONFigure:STANdard` on page 112

#### Frequency

Specifies the center frequency of the signal to be measured.

SCPI command:

`[SENSe:] FREQuency:CENTer` on page 115

### 5.3.4 Input and Frontend Settings

The R&S FSW can analyze signals from different input sources and provide various types of output (such as noise or trigger signals).



#### Importing and Exporting I/Q Data

The I/Q data to be analyzed for WLAN 802.11 can not only be measured by the WLAN application itself, it can also be imported to the application, provided it has the correct format. Furthermore, the analyzed I/Q data from the WLAN application can be exported for further analysis in external applications.

See [chapter 4.5.2, "Importing and Exporting I/Q Data"](#), on page 45.



Frequency, amplitude and y-axis scaling settings represent the "frontend" of the measurement setup.

For more information on the use and effects of these settings, see [chapter 4.6, "Preparing the R&S FSW for the Expected Input Signal - Frontend Parameters"](#), on page 46.

- [Input Settings](#).....57
- [Data Output](#).....59
- [Frequency Settings](#).....61
- [Amplitude Settings](#).....62

### 5.3.4.1 Input Settings

The input signal determines which data the R&S FSW will analyze.

Input settings can be configured via the INPUT/OUTPUT key, in the "Input" dialog box.

Some settings are also available in the "Amplitude" tab of the "Amplitude" dialog box.



The Digital I/Q input source is currently not available in the R&S FSW WLAN application.

- [Radio Frequency Input](#).....57

#### Radio Frequency Input

The default input source for the R&S FSW is "Radio Frequency", i.e. the signal at the RF INPUT connector on the front panel of the R&S FSW. If no additional options are installed, this is the only available input source.

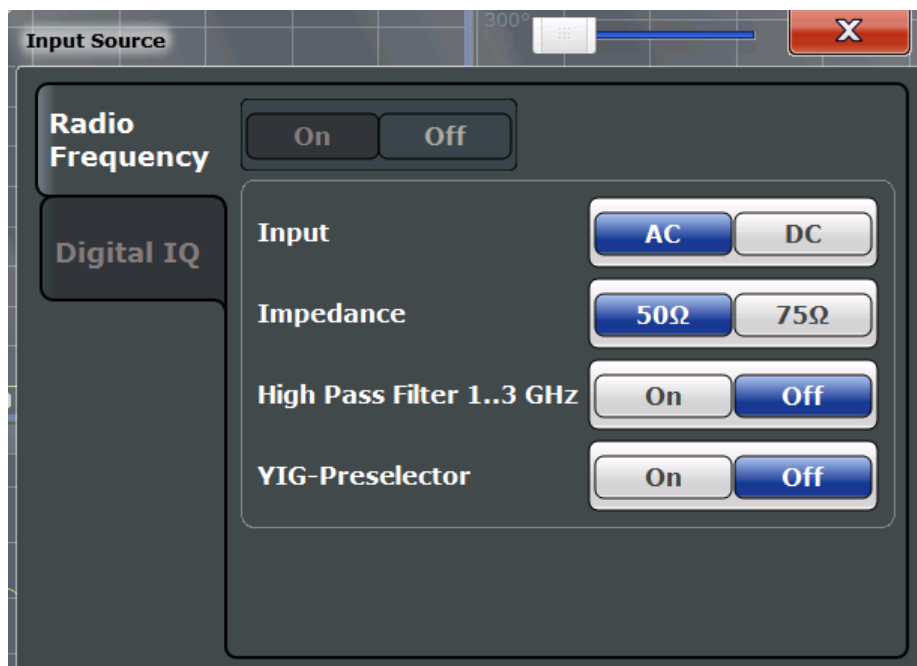

Radio Frequency State.....	58
Input Coupling.....	58
Impedance.....	58
High-Pass Filter 1...3 GHz.....	58
YIG-Preselector.....	58

### Radio Frequency State

Activates input from the RF INPUT connector.

SCPI command:

`INPut:SElect` on page 114

### Input Coupling

The RF input of the R&S FSW can be coupled by alternating current (AC) or direct current (DC).

AC coupling blocks any DC voltage from the input signal. This is the default setting to prevent damage to the instrument. Very low frequencies in the input signal may be distorted.

However, some specifications require DC coupling. In this case, you must protect the instrument from damaging DC input voltages manually. For details, refer to the data sheet.

SCPI command:

`INPut:COUpling` on page 113

### Impedance

The reference impedance for the measured levels of the R&S FSW can be set to 50  $\Omega$  or 75  $\Omega$ .

75  $\Omega$  should be selected if the 50  $\Omega$  input impedance is transformed to a higher impedance using a 75  $\Omega$  adapter of the RAZ type (= 25  $\Omega$  in series to the input impedance of the instrument). The correction value in this case is 1.76 dB = 10 log (75 $\Omega$ /50 $\Omega$ ).

SCPI command:

`INPut:IMPedance` on page 114

### High-Pass Filter 1...3 GHz

Activates an additional internal high-pass filter for RF input signals from 1 GHz to 3 GHz. This filter is used to remove the harmonics of the R&S FSW in order to measure the harmonics for a DUT, for example.

This function requires option R&S FSW-B13.

(Note: for RF input signals outside the specified range, the high-pass filter has no effect. For signals with a frequency of approximately 4 GHz upwards, the harmonics are suppressed sufficiently by the YIG filter.)

SCPI command:

`INPut:FILTer:HPASs[:STATe]` on page 113

### YIG-Preselector

Activates or deactivates the YIG-preselector.

An internal YIG-preselector at the input of the R&S FSW ensures that image frequencies are rejected. However, the YIG filter may limit the bandwidth of the I/Q data and will add some magnitude and phase distortions. You can check the impact in the Spectrum Flatness and Group Delay result displays.

Note that the YIG-preselector is active only on frequencies greater than 8 GHz. Therefore, switching the YIG-preselector on or off has no effect if the frequency is below that value.

[INPut:FILTer:YIG\[:STATe\]](#) on page 113

### 5.3.4.2 Data Output

The R&S FSW can provide output to special connectors for other devices.

For details on connectors refer to the R&S FSW Getting Started manual, "Front / Rear Panel View" chapters.



How to provide trigger signals as output is described in detail in the R&S FSW User Manual.

Output settings can be configured via the INPUT/OUTPUT key or in the "Outputs" dialog box.

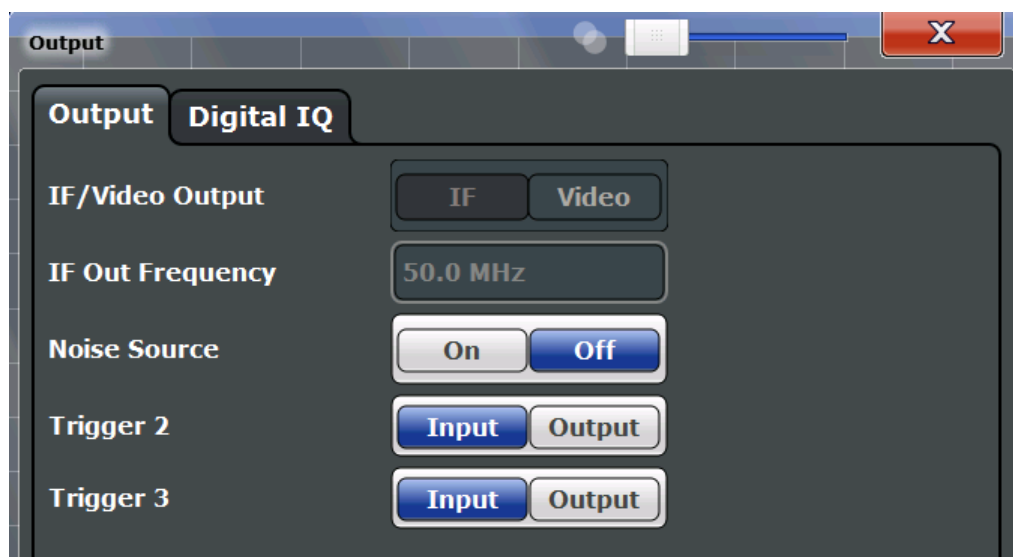

Noise Source.....	59
Trigger 2/3.....	60
L Output Type.....	60
L Level.....	60
L Pulse Length.....	61
L Send Trigger.....	61

#### Noise Source

Switches the supply voltage for an external noise source on or off.

## Default WLAN Measurement (Modulation Accuracy, Flatness, Tolerance...)

External noise sources are useful when you are measuring power levels that fall below the noise floor of the R&S FSW itself, for example when measuring the noise level of a DUT.

For details see [chapter 4.5.3, "Input from Noise Sources"](#), on page 45

SCPI command:

[DIAGnostic<n>:SERvice:NSource](#) on page 115

**Trigger 2/3**

Defines the usage of the variable TRIGGER INPUT/OUTPUT connectors, where:

"Trigger 2": TRIGGER INPUT/OUTPUT connector on the front panel

"Trigger 3": TRIGGER 3 INPUT/ OUTPUT connector on the rear panel

(Trigger 1 is INPUT only.)

**Note:** Providing trigger signals as output is described in detail in the R&S FSW User Manual.

"Input"                    The signal at the connector is used as an external trigger source by the R&S FSW. No further trigger parameters are available for the connector.

"Output"                   The R&S FSW sends a trigger signal to the output connector to be used by connected devices.  
Further trigger parameters are available for the connector.

SCPI command:

[OUTPut:TRIGger<port>:LEVel](#) on page 128

[OUTPut:TRIGger<port>:DIRection](#) on page 128

**Output Type ← Trigger 2/3**

Type of signal to be sent to the output

"Device Triggered"      (Default) Sends a trigger when the R&S FSW triggers.

"Trigger Armed"                Sends a (high level) trigger when the R&S FSW is in "Ready for trigger" state.  
This state is indicated by a status bit in the `STATUS:OPERation` register (bit 5), as well as by a low level signal at the AUX port (pin 9).

"User Defined"                Sends a trigger when user selects "Send Trigger" button.  
In this case, further parameters are available for the output signal.

SCPI command:

[OUTPut:TRIGger<port>:OTYPe](#) on page 129

**Level ← Output Type ← Trigger 2/3**

Defines whether a constant high (1) or low (0) signal is sent to the output connector.

SCPI command:

[OUTPut:TRIGger<port>:LEVel](#) on page 128

**Pulse Length ← Output Type ← Trigger 2/3**

Defines the length of the pulse sent as a trigger to the output connector.

SCPI command:

[OUTPut:TRIGger<port>:PULSe:LENGth](#) on page 130

**Send Trigger ← Output Type ← Trigger 2/3**

Sends a user-defined trigger to the output connector immediately. Note that the trigger pulse level is always opposite to the constant signal level defined by the output "Level" setting, e.g. for "Level = High", a constant high signal is output to the connector until the "Send Trigger" button is selected. Then, a low pulse is sent.

Which pulse level will be sent is indicated by a graphic on the button.

SCPI command:

[OUTPut:TRIGger<port>:PULSe:IMMediate](#) on page 129

**5.3.4.3 Frequency Settings**

Frequency settings for the input signal can be configured via the "Frequency" dialog box, which is displayed when you do one of the following:

- Select the **FREQ** key and then the "Frequency Config" softkey.
- Select "Input/Frontend" from the "Overview" and then switch to the "Frequency" tab.

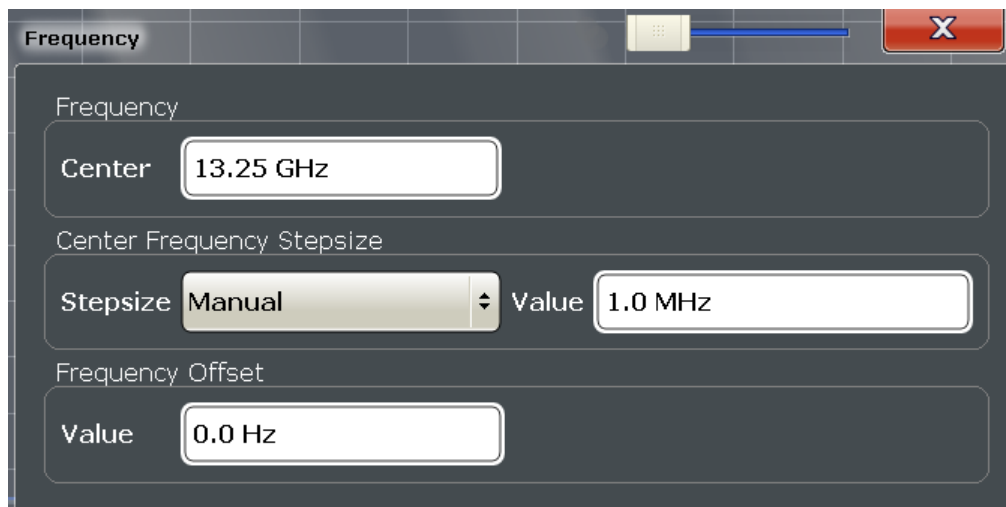

[Center](#).....61  
[Center Frequency Stepsize](#).....62  
[Frequency Offset](#).....62

**Center**

Defines the normal center frequency of the signal. The allowed range of values for the center frequency depends on the frequency span.

$f_{max}$  and  $span_{min}$  are specified in the data sheet.

SCPI command:

[\[SENSe:\] FREQuency:CENTer](#) on page 115

**Center Frequency Stepsize**

Defines the step size by which the center frequency is increased or decreased when the arrow keys are pressed. When you use the rotary knob the center frequency changes in steps of only 1/10 of the "Center Frequency Stepsize".

The step size can be coupled to another value or it can be manually set to a fixed value.

"= Center" Sets the step size to the value of the center frequency. The used value is indicated in the "Value" field.

"Manual" Defines a fixed step size for the center frequency. Enter the step size in the "Value" field.

SCPI command:

[\[SENSe:\] FREQuency:CENTer:STEP](#) on page 116

**Frequency Offset**

Shifts the displayed frequency range along the x-axis by the defined offset.

This parameter has no effect on the R&S FSW hardware, or on the captured data or on data processing. It is simply a manipulation of the final results in which absolute frequency values are displayed. Thus, the x-axis of a spectrum display is shifted by a constant offset if it shows absolute frequencies, but not if it shows frequencies relative to the signal's center frequency.

A frequency offset can be used to correct the display of a signal that is slightly distorted by the measurement setup, for example.

The allowed values range from -100 GHz to 100 GHz. The default setting is 0 Hz.

SCPI command:

[\[SENSe:\] FREQuency:OFFSet](#) on page 117

**5.3.4.4 Amplitude Settings**

Amplitude settings determine how the R&S FSW must process or display the expected input power levels.

**To configure the amplitude settings**

Amplitude settings can be configured via the AMPT key or in the "Amplitude" dialog box.

- ▶ To display the "Amplitude" dialog box, do one of the following:
  - Select "Input/Frontend" from the "Overview" and then switch to the "Amplitude" tab.
  - Select the AMPT key and then the "Amplitude Config" softkey.

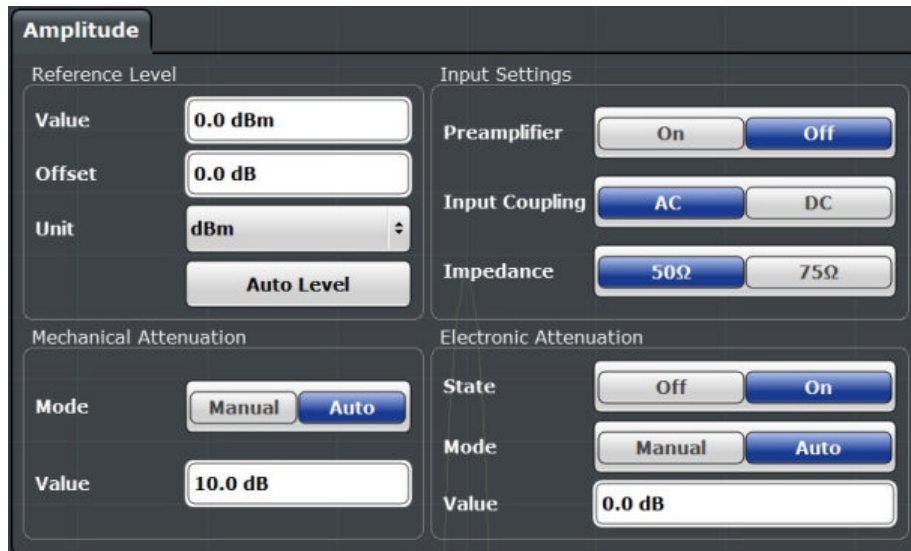

Reference Level.....63

- └ Shifting the Display (Offset).....63
- └ Setting the Reference Level Automatically (Auto Level).....64

RF Attenuation.....64

- └ Attenuation Mode / Value.....64

Using Electronic Attenuation (Option B25).....64

Input Settings.....65

- └ Preamplifier (option B24).....65

**Reference Level**

Defines the expected maximum reference level. Signal levels above this value may not be measured correctly, which is indicated by the "IFOVL" status display.

The reference level is also used to scale power diagrams; the reference level is then used as the maximum on the y-axis.

Since the R&S FSW hardware is adapted according to this value, it is recommended that you set the reference level close above the expected maximum signal level to ensure an optimum measurement (no compression, good signal-to-noise ratio).

Note that the "Reference Level" value ignores the [Shifting the Display \(Offset\)](#). It is important to know the actual power level the R&S FSW must handle.

Check the trace in the Magnitude Capture display to determine the suitable reference level. Look for the maximum instantaneous level of the strongest PPDU in the RF input signal.

SCPI command:

[DISPlay\[:WINDow<n>\]:TRACe:Y\[:SCALE\]:RLEVel](#) on page 117

**Shifting the Display (Offset) ← Reference Level**

Defines an arithmetic level offset. This offset is added to the measured level irrespective of the selected unit. The scaling of the y-axis is changed accordingly.

Define an offset if the signal is attenuated or amplified before it is fed into the R&S FSW so the application shows correct power results. All displayed power level results will be shifted by this value.

## Default WLAN Measurement (Modulation Accuracy, Flatness, Tolerance...)

Note, however, that the [Reference Level](#) value ignores the "Reference Level Offset". It is important to know the actual power level the R&S FSW must handle.

To determine the required offset, consider the external attenuation or gain applied to the input signal. A positive value indicates that an attenuation took place (R&S FSW increases the displayed power values), a negative value indicates an external gain (R&S FSW decreases the displayed power values).

The setting range is  $\pm 200$  dB in 0.01 dB steps.

SCPI command:

[DISPlay\[:WINDow<n>\]:TRACe:Y\[:SCALE\]:RLEVEL:OFFSet](#) on page 118

### Setting the Reference Level Automatically (Auto Level) ← Reference Level

Automatically determines the optimal reference level for the current input data. At the same time, the internal attenuators and the preamplifier are adjusted so the signal-to-noise ratio is optimized, while signal compression, clipping and overload conditions are minimized.

In order to do so, a level measurement is performed to determine the optimal reference level.

You can change the measurement time for the level measurement if necessary (see ["Changing the Automatic Measurement Time \(Meastime Manual\)"](#) on page 86).

SCPI command:

[\[SENSe:\]ADJust:LEVel](#) on page 149

### RF Attenuation

Defines the attenuation applied to the RF input.

#### Attenuation Mode / Value ← RF Attenuation

The RF attenuation can be set automatically as a function of the selected reference level (Auto mode). This ensures that the optimum RF attenuation is always used. It is the default setting. By default and when [Using Electronic Attenuation \(Option B25\)](#) is not available, mechanical attenuation is applied.

In "Manual" mode, you can set the RF attenuation in 1 dB steps (down to 0 dB, also using the rotary knob). Other entries are rounded to the next integer value. The range is specified in the data sheet. If the defined reference level cannot be set for the defined RF attenuation, the reference level is adjusted accordingly and the warning "Limit reached" is displayed.

**NOTICE!** Risk of hardware damage due to high power levels. When decreasing the attenuation manually, ensure that the power level does not exceed the maximum level allowed at the RF input, as an overload may lead to hardware damage.

SCPI command:

[INPut:ATTenuation](#) on page 118

[INPut:ATTenuation:AUTO](#) on page 118

#### Using Electronic Attenuation (Option B25)

If option R&S FSW-B25 is installed, you can also activate an electronic attenuator.

In "Auto" mode, the settings are defined automatically; in "Manual" mode, you can define the mechanical and electronic attenuation separately.



**Note:** Electronic attenuation is not available for stop frequencies (or center frequencies in zero span) >13.6 GHz.

In "Auto" mode, RF attenuation is provided by the electronic attenuator as much as possible to reduce the amount of mechanical switching required. Mechanical attenuation may provide a better signal-to-noise ratio, however.

When you switch off electronic attenuation, the RF attenuation is automatically set to the same mode (auto/manual) as the electronic attenuation was set to. Thus, the RF attenuation may be set to automatic mode, and the full attenuation is provided by the mechanical attenuator, if possible.

Both the electronic and the mechanical attenuation can be varied in 1 dB steps. Other entries are rounded to the next lower integer value.

If the defined reference level cannot be set for the given attenuation, the reference level is adjusted accordingly and the warning "Limit reached" is displayed in the status bar.

SCPI command:

[INPut:EATT:STATe](#) on page 119

[INPut:EATT:AUTO](#) on page 119

[INPut:EATT](#) on page 119

### Input Settings

Some input settings affect the measured amplitude of the signal, as well.

The parameters "Input Coupling" and "Impedance" are identical to those in the "Input" settings, see [chapter 5.3.4.1, "Input Settings"](#), on page 57.

### Preamplifier (option B24) ← Input Settings

If option R&S FSW-B24 is installed, a preamplifier can be activated for the RF input signal.

For R&S FSW 26 models, the input signal is amplified by 30 dB if the preamplifier is activated.

For R&S FSW 8 or 13 models, the following settings are available:

- |         |  |
|---------|--|
| "Off"   | Deactivates the preamplifier.                    |
| "15 dB" | The RF input signal is amplified by about 15 dB. |
| "30 dB" | The RF input signal is amplified by about 30 dB. |

SCPI command:

[INPut:GAIN:STATe](#) on page 120

[INPut:GAIN\[:VALue\]](#) on page 120

## 5.3.5 Signal Capture (Data Acquisition)

You can define how much and how data is captured from the input signal.

- [General Capture Settings](#).....66
- [Trigger Settings](#).....67

### 5.3.5.1 General Capture Settings

The general capture settings define how much and which data is to be captured during the default WLAN measurement.

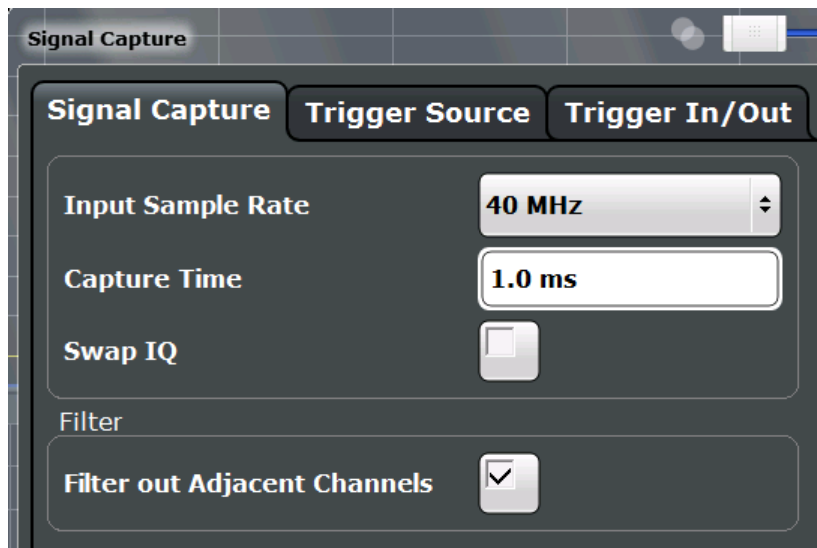

Input Sample Rate.....	66
Capture Time.....	66
Swap IQ.....	66
Suppressing (Filter out) Adjacent Channels.....	67

#### Input Sample Rate

This is the sample rate the R&S FSW WLAN application expects the I/Q input data to have. If necessary, the R&S FSW has to resample the data.

During data processing in the R&S FSW, the sample rate usually changes (decreases). The RF input is captured by the R&S FSW using a high sample rate, and is resampled before it is processed by the R&S FSW WLAN application.

SCPI command:

[TRACe: IQ: SRATe](#) on page 122

#### Capture Time

Specifies the duration (and therefore the amount of data) to be captured in the capture buffer. If the capture time is too short, demodulation will fail.

SCPI command:

[\[SENSe:\] SWEep: TIME](#) on page 122

#### Swap IQ

Activates or deactivates the inverted I/Q modulation. If the DUT interchanged the I and Q parts of the signal, the FSW can do the same to compensate for it.

## Default WLAN Measurement (Modulation Accuracy, Flatness, Tolerance...)

On	I and Q signals are interchanged Inverted sideband, $Q+j*I$
Off	I and Q signals are not interchanged Normal sideband, $I+j*Q$

SCPI command:

[\[SENSe:\]SWAPiq](#) on page 121

### Suppressing (Filter out) Adjacent Channels

If activated (default), only the useful signal is analyzed, all signal data in adjacent channels is removed by the filter.

This setting improves the signal to noise ratio and thus the EVM results for signals with strong or a large number of adjacent channels. However, for some measurements information on the effects of adjacent channels on the measured signal may be of interest.

SCPI command:

[\[SENSe:\]BANDwidth\[:RESolution\]:FILTer\[:STATe\]](#) on page 121

### 5.3.5.2 Trigger Settings

Trigger settings determine when the R&S FSW starts to capture the input signal.

Trigger settings can be configured via the TRIG key or in the "Trigger" dialog box, which is displayed when you select the "Trigger" button in the "Overview".

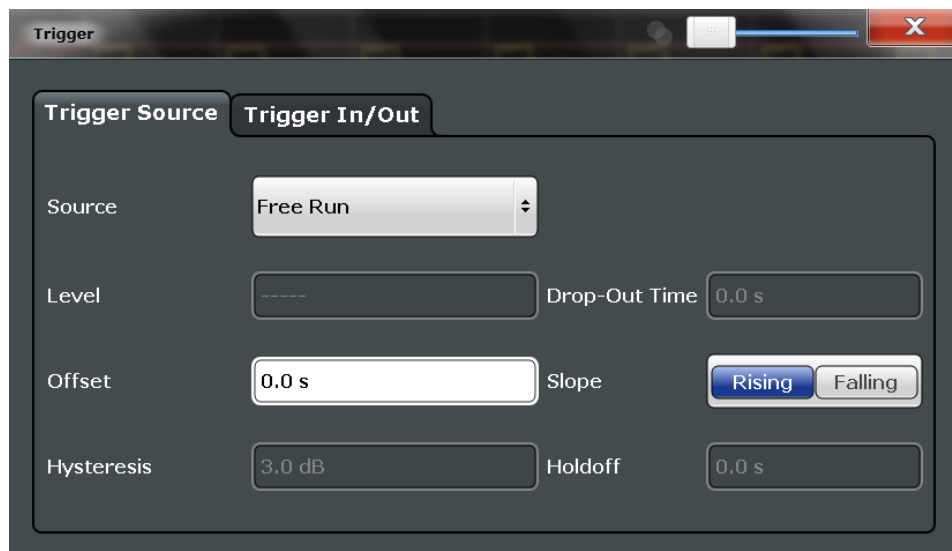

External triggers from one of the TRIGGER INPUT/OUTPUT connectors on the R&S FSW are configured in a separate tab of the dialog box.

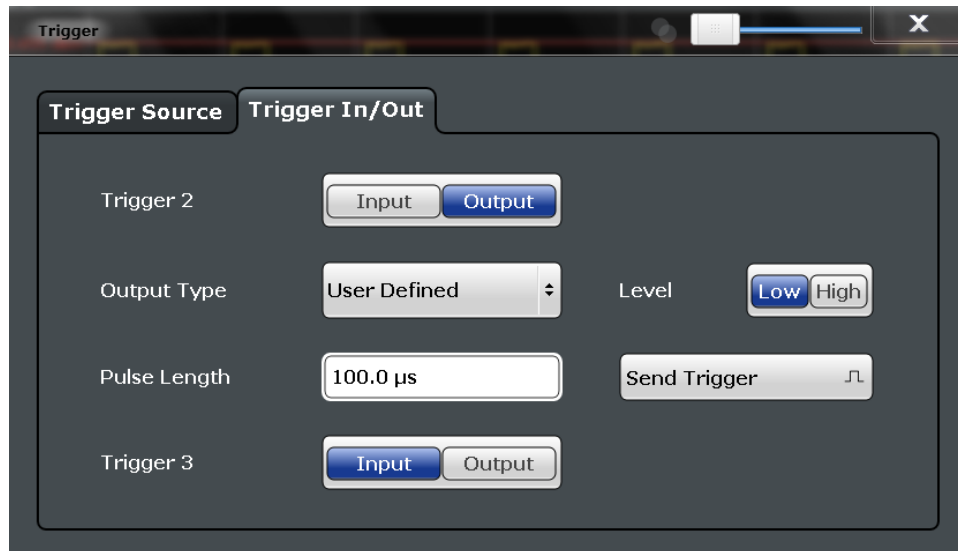

For more information on trigger settings and step-by-step instructions on configuring triggered measurements, see the R&S FSW User Manual.

- Trigger Source Settings..... 68
  - L Trigger Source..... 69
    - L Free Run..... 69
    - L External Trigger 1/2/3..... 69
    - L IF Power..... 69
    - L IQ Power..... 70
    - L RF Power..... 70
    - L Power Sensor..... 70
    - L Time..... 70
  - L Trigger Level..... 71
  - L Repetition Interval..... 71
  - L Drop-Out Time..... 71
  - L Trigger Offset..... 71
  - L Hysteresis..... 71
  - L Trigger Holdoff..... 72
  - L Slope..... 72
- Trigger 2/3..... 72
  - L Output Type..... 72
    - L Level..... 73
    - L Pulse Length..... 73
    - L Send Trigger..... 73

**Trigger Source Settings**

The Trigger Source settings define when data is captured.

**Trigger Source ← Trigger Source Settings**

Defines whether a trigger is to be considered at all and if so, which signal (IF, RF, power sensor, external signal etc.) will provide the trigger signal. If a trigger source other than "Free Run" is set, "TRG" is displayed in the channel bar and the trigger source is indicated.

SCPI command:

[TRIGger \[:SEquence\] :SOURce](#) on page 126

**Free Run ← Trigger Source ← Trigger Source Settings**

No trigger source is considered. Data acquisition is started manually or automatically and continues until stopped explicitly.

SCPI command:

TRIG:SOUR IMM, see [TRIGger \[:SEquence\] :SOURce](#) on page 126

**External Trigger 1/2/3 ← Trigger Source ← Trigger Source Settings**

Data acquisition starts when the TTL signal fed into the specified input connector (on the front or rear panel) meets or exceeds the specified trigger level.

(See "[Trigger Level](#)" on page 71).

**Note:** The "External Trigger 1" softkey automatically selects the trigger signal from the TRIGGER INPUT connector on the front panel.

For details see the "Instrument Tour" chapter in the R&S FSW Getting Started manual.

"External Trigger 1"

Trigger signal from the TRIGGER INPUT connector on the front panel.

"External Trigger 2"

Trigger signal from the TRIGGER INPUT/OUTPUT connector on the front panel.

Note: Connector must be configured for "Input" in the "Outputs" configuration (see "[Trigger 2/3](#)" on page 60).

"External Trigger 3"

Trigger signal from the TRIGGER 3 INPUT/ OUTPUT connector on the rear panel.

Note: Connector must be configured for "Input" in the "Outputs" configuration (see "[Trigger 2/3](#)" on page 60).

SCPI command:

TRIG:SOUR EXT, TRIG:SOUR EXT2, TRIG:SOUR EXT3

See [TRIGger \[:SEquence\] :SOURce](#) on page 126

**IF Power ← Trigger Source ← Trigger Source Settings**

The R&S FSW starts capturing data as soon as the trigger threshold is exceeded around the third intermediate frequency.

For frequency sweeps, the third IF represents the start frequency. The trigger bandwidth at the third IF depends on the RBW and sweep type.

For measurements on a fixed frequency (e.g. zero span or I/Q measurements), the third IF represents the center frequency.

## Default WLAN Measurement (Modulation Accuracy, Flatness, Tolerance...)

The trigger threshold depends on the defined trigger level, as well as on the RF attenuation and preamplification. For details on available trigger levels and trigger bandwidths see the data sheet.

This trigger source is only available for RF input.

SCPI command:

TRIG:SOUR IFP, see TRIGger[:SEquence]:SOURce on page 126

**IQ Power ← Trigger Source ← Trigger Source Settings**

Triggers the measurement when the magnitude of the sampled I/Q data exceeds the trigger threshold.

The trigger bandwidth corresponds to the "Usable I/Q Bandwidth", which depends on the sample rate of the captured I/Q data (see "Input Sample Rate" on page 66 and [chapter A.1, "Sample Rate and Maximum Usable I/Q Bandwidth for RF Input"](#), on page 201).

SCPI command:

TRIG:SOUR IQP, see TRIGger[:SEquence]:SOURce on page 126

**RF Power ← Trigger Source ← Trigger Source Settings**

Defines triggering of the measurement via signals which are outside the displayed measurement range.

For this purpose the instrument uses a level detector at the first intermediate frequency. The input signal must be in the frequency range between 500 MHz and 8 GHz. The resulting trigger level at the RF input depends on the RF attenuation and preamplification. For details on available trigger levels see the data sheet.

**Note:** If the input signal contains frequencies outside of this range (e.g. for fullspan measurements), the sweep may be aborted and a message indicating the allowed input frequencies is displayed in the status bar.

A "Trigger Offset", "Trigger Polarity" and "Trigger Holdoff" (to improve the trigger stability) can be defined for the RF trigger, but no "Hysteresis".

SCPI command:

TRIG:SOUR RFP, see TRIGger[:SEquence]:SOURce on page 126

**Power Sensor ← Trigger Source ← Trigger Source Settings**

Uses an external power sensor as a trigger source. This option is only available if a power sensor is connected and configured.

**Note:** For R&S power sensors, the "Gate Mode" *Lvl* is not supported. The signal sent by these sensors merely reflects the instant the level is first exceeded, rather than a time period. However, only time periods can be used for gating in level mode. Thus, the trigger impulse from the sensors is not long enough for a fully gated measurement; the measurement cannot be completed.

SCPI command:

TRIG:SOUR PSE, see TRIGger[:SEquence]:SOURce on page 126

**Time ← Trigger Source ← Trigger Source Settings**

Triggers in a specified repetition interval.

SCPI command:

TRIG:SOUR TIME, see TRIGger[:SEquence]:SOURce on page 126

**Trigger Level ← Trigger Source Settings**

Defines the trigger level for the specified trigger source.

For details on supported trigger levels, see the data sheet.

SCPI command:

[TRIGger\[:SEquence\]:LEVel:IFPower](#) on page 125

[TRIGger\[:SEquence\]:LEVel:IQPower](#) on page 125

[TRIGger\[:SEquence\]:LEVel\[:EXternal<port>\]](#) on page 124

[TRIGger\[:SEquence\]:LEVel:RFPower](#) on page 125

**Repetition Interval ← Trigger Source Settings**

Defines the repetition interval for a time trigger. The shortest interval is 2 ms.

The repetition interval should be set to the exact pulse period, burst length, frame length or other repetitive signal characteristic.

SCPI command:

[TRIGger\[:SEquence\]:TIME:RINterval](#) on page 127

**Drop-Out Time ← Trigger Source Settings**

Defines the time the input signal must stay below the trigger level before triggering again.

For more information on the drop-out time see [chapter 4.7.3, "Trigger Drop-Out Time"](#), on page 48.

SCPI command:

[TRIGger\[:SEquence\]:DTIME](#) on page 123

**Trigger Offset ← Trigger Source Settings**

Defines the time offset between the trigger event and the start of the sweep.

For more information see [chapter 4.7.1, "Trigger Offset"](#), on page 48.

offset > 0:	Start of the sweep is delayed
offset < 0:	Sweep starts earlier (pre-trigger)

SCPI command:

[TRIGger\[:SEquence\]:HOLDoff\[:TIME\]](#) on page 123

**Hysteresis ← Trigger Source Settings**

Defines the distance in dB to the trigger level that the trigger source must exceed before a trigger event occurs. Setting a hysteresis avoids unwanted trigger events caused by noise oscillation around the trigger level.

This setting is only available for "IF Power" trigger sources. The range of the value is between 3 dB and 50 dB with a step width of 1 dB.

For more information see [chapter 4.7.2, "Trigger Hysteresis"](#), on page 48.

SCPI command:

[TRIGger\[:SEquence\]:IFPower:HYSteresis](#) on page 124

**Trigger Holdoff ← Trigger Source Settings**

Defines the minimum time (in seconds) that must pass between two trigger events. Trigger events that occur during the holdoff time are ignored.

For more information see [chapter 4.7.4, "Trigger Holdoff"](#), on page 49.

SCPI command:

[TRIGger\[:SEquence\]:IFPower:HOLDoFF](#) on page 123

**Slope ← Trigger Source Settings**

For all trigger sources except time you can define whether triggering occurs when the signal rises to the trigger level or falls down to it.

SCPI command:

[TRIGger\[:SEquence\]:SLOPe](#) on page 126

**Trigger 2/3**

Defines the usage of the variable TRIGGER INPUT/OUTPUT connectors, where:

"Trigger 2": TRIGGER INPUT/OUTPUT connector on the front panel

"Trigger 3": TRIGGER 3 INPUT/ OUTPUT connector on the rear panel

(Trigger 1 is INPUT only.)

**Note:** Providing trigger signals as output is described in detail in the R&S FSW User Manual.

"Input"                    The signal at the connector is used as an external trigger source by the R&S FSW. No further trigger parameters are available for the connector.

"Output"                   The R&S FSW sends a trigger signal to the output connector to be used by connected devices.  
Further trigger parameters are available for the connector.

SCPI command:

[OUTPut:TRIGger<port>:LEVel](#) on page 128

[OUTPut:TRIGger<port>:DIRection](#) on page 128

**Output Type ← Trigger 2/3**

Type of signal to be sent to the output

"Device Triggered"      (Default) Sends a trigger when the R&S FSW triggers.

"Trigger Armed"           Sends a (high level) trigger when the R&S FSW is in "Ready for trigger" state.  
This state is indicated by a status bit in the `STATUS:OPERation` register (bit 5), as well as by a low level signal at the AUX port (pin 9).

"User Defined"           Sends a trigger when user selects "Send Trigger" button.  
In this case, further parameters are available for the output signal.

SCPI command:

[OUTPut:TRIGger<port>:OTYPe](#) on page 129



**Level ← Output Type ← Trigger 2/3**

Defines whether a constant high (1) or low (0) signal is sent to the output connector.

SCPI command:

[OUTPut:TRIGger<port>:LEVel](#) on page 128

**Pulse Length ← Output Type ← Trigger 2/3**

Defines the length of the pulse sent as a trigger to the output connector.

SCPI command:

[OUTPut:TRIGger<port>:PULSe:LENGth](#) on page 130

**Send Trigger ← Output Type ← Trigger 2/3**

Sends a user-defined trigger to the output connector immediately. Note that the trigger pulse level is always opposite to the constant signal level defined by the output "Level" setting, e.g. for "Level = High", a constant high signal is output to the connector until the "Send Trigger" button is selected. Then, a low pulse is sent.

Which pulse level will be sent is indicated by a graphic on the button.

SCPI command:

[OUTPut:TRIGger<port>:PULSe:IMMediate](#) on page 129

### 5.3.6 Synchronization and OFDM Demodulation

Synchronization settings have an effect on which parts of the input signal are processed during the WLAN measurement.

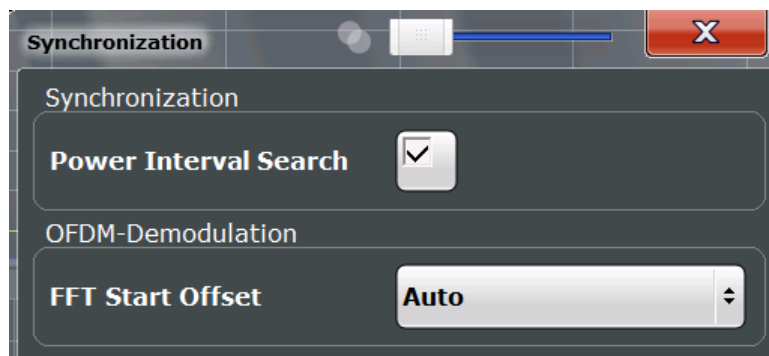

<a href="#">Power Interval Search</a> .....	73
<a href="#">FFT Start Offset</a> .....	74

**Power Interval Search**

If enabled, the R&S FSW WLAN application initially performs a coarse burst search on the input signal in which increases in the power vs time trace are detected. Further time-consuming processing is then only performed where bursts are assumed. This improves the measurement speed for signals with low duty cycle rates.

However, for signals in which the PPDU power levels differ significantly, this option should be disabled as otherwise some PPDUs may not be detected.

SCPI command:

[\[SENSe:\] DEMod:TXARea](#) on page 130

**FFT Start Offset**

This command specifies the start offset of the FFT for OFDM demodulation (not for the FFT Spectrum display).

"AUTO"

The FFT start offset is automatically chosen to minimize the intersymbol interference.

"Guard Interval Cntr"

Guard Interval Center: The FFT start offset is placed to the center of the guard interval.

"Peak"

The peak of the fine timing metric is used to determine the FFT start offset.

SCPI command:

[SENSe:]DEMod:FFT:OFFSet on page 130

### 5.3.7 Tracking and Channel Estimation

The channel estimation settings determine which channels are assumed in the input signal. Tracking settings allow for compensation of some transmission effects in the signal (see "Tracking the phase drift, timing jitter and gain" on page 38).

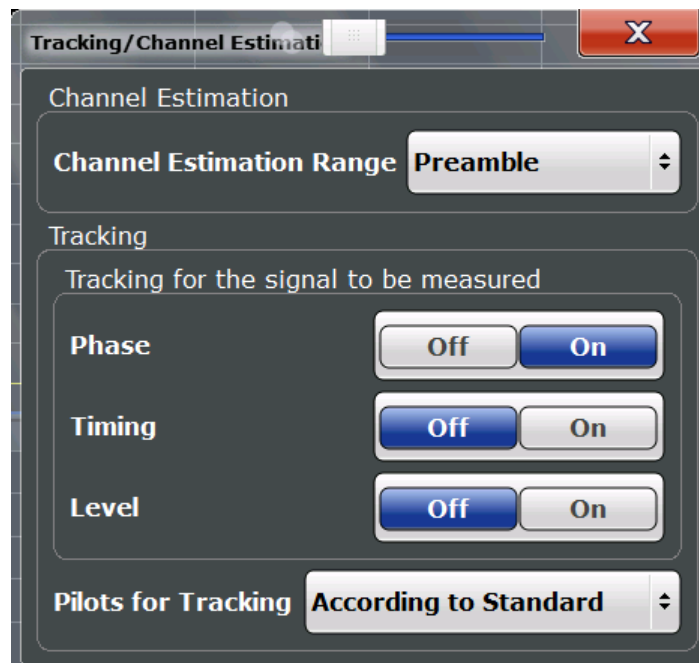

Channel Estimation Range.....	75
Phase Tracking.....	75
Timing Error Tracking.....	75
Level Error (Gain) Tracking.....	75
Pilots for Tracking.....	75

**Channel Estimation Range**

Specifies the signal range used to estimate the channels.

"Preamble" The channel estimation is performed in the preamble as required in the standard.

"Payload" The channel estimation is performed in the preamble and the payload. The EVM results can be calculated more accurately.

SCPI command:

[\[SENSe:\]DEMod:CESTimation](#) on page 131

**Phase Tracking**

Activates or deactivates the compensation for phase drifts. If activated, the measurement results are compensated for phase drifts on a per-symbol basis.

SCPI command:

[\[SENSe:\]TRACking:PHASe](#) on page 132

**Timing Error Tracking**

Activates or deactivates the compensation for timing drift. If activated, the measurement results are compensated for timing error on a per-symbol basis.

SCPI command:

[\[SENSe:\]TRACking:TIME](#) on page 132

**Level Error (Gain) Tracking**

Activates or deactivates the compensation for level drifts within a single PPDU. If activated, the measurement results are compensated for level error on a per-symbol basis.

SCPI command:

[\[SENSe:\]TRACking:LEVel](#) on page 131

**Pilots for Tracking**

In case tracking is used, the used pilot sequence has an effect on the measurement results.

"According to standard"

The pilot sequence is determined according to the corresponding WLAN standard. In case the pilot generation algorithm of the device under test (DUT) has a problem, the non-standard-conform pilot sequence might affect the measurement results, or the WLAN application might not synchronize at all onto the signal generated by the DUT.

"Detected"

The pilot sequence detected in the WLAN signal to be analyzed is used by the WLAN application. In case the pilot generation algorithm of the device under test (DUT) has a problem, the non-standard-conform pilot sequence will not affect the measurement results. In case the pilot sequence generated by the DUT is correct, it is recommended that you use the "According to Standard" setting because it generates more accurate measurement results.

SCPI command:

[\[SENSe:\]TRACking:PILots](#) on page 132

### 5.3.8 Demodulation

The demodulation settings define which PPDUs are to be analyzed, thus they define a *logical filter*.

The available demodulation settings vary depending on the selected digital standard in the "Signal Description" (see "Standard" on page 56).

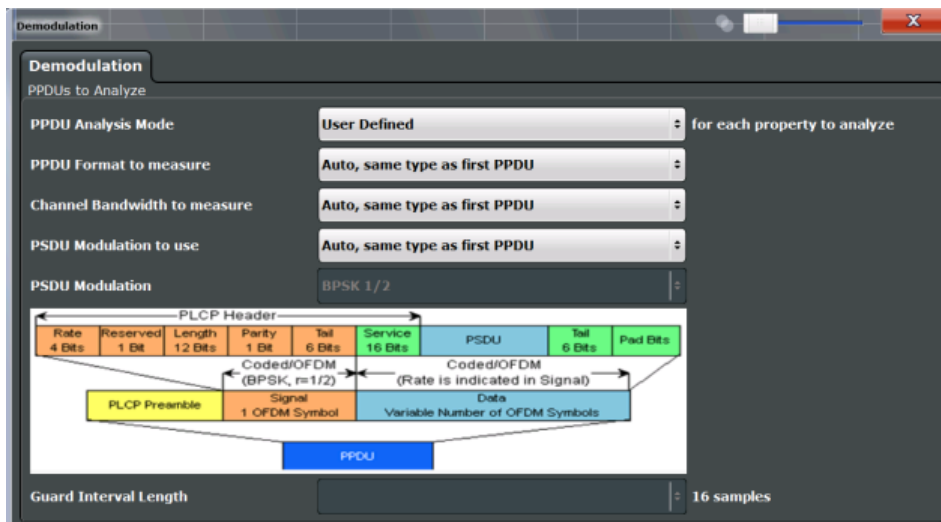

Fig. 5-1: Demodulation settings for IEEE 802.11a standard

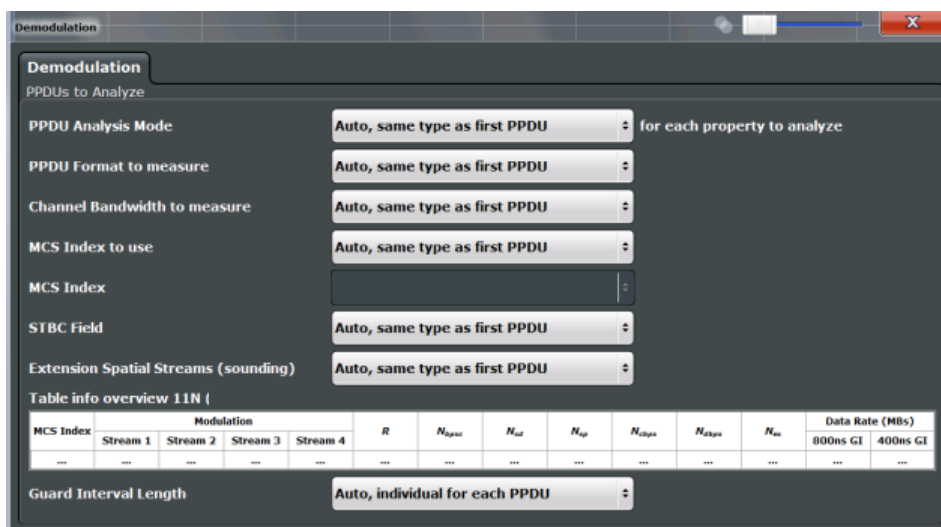

Fig. 5-2: Demodulation settings for IEEE 802.11n standard

PPDU Analysis Mode.....77

PPDU Format to measure.....77

Channel Bandwidth to measure (CBW).....78

PSDU Modulation to use (IEEE 802.11 A).....78

PSDU Modulation (IEEE 802.11 A).....79

MCS Index to use (IEEE 802.11 N, AC).....79

MCS Index (IEEE 802.11 N, AC).....79

## Default WLAN Measurement (Modulation Accuracy, Flatness, Tolerance...)

Nsts to use (IEEE 802.11 AC).....	79
Nsts (IEEE 802.11 AC).....	80
STBC Field (IEEE 802.11 AC,N).....	80
Extension Spatial Streams (sounding) (IEEE 802.11 N).....	81
Table info overview (IEEE 802.11 N, AC).....	81
Guard Interval Length (IEEE 802.11 N, AC).....	81

**PPDU Analysis Mode**

Defines whether all or only specific PPDU are to be analyzed.

"Auto, same type as first PPDU"

The signal symbol field, i.e. the PLCP header field, of the first recognized PPDU is analyzed to determine the details of the PPDU. All PPDU identical to the first recognized PPDU are analyzed. All subsequent settings are set to "Auto" mode.

"Auto, individually for each PPDU"

All PPDU are analyzed

"User-defined"

User-defined settings define which PPDU are analyzed. This setting is automatically selected when any of the subsequent settings are changed to a value other than "Auto".

SCPI command:

[SENSe:] DEMod: FORMat [: BCONtent] : AUTO on page 139

**PPDU Format to measure**

Defines which PPDU formats are to be included in the analysis. Depending on which standards the communicating devices are using, different formats of PPDU are available. Thus you can restrict analysis to the supported formats.

**Note:** The PPDU format determines the available channel bandwidths.

For details on supported PPDU formats and channel bandwidths depending on the standard see [table 4-1](#).

**Note:** The terms in brackets in the following description indicate how the setting is referred to in the Signal Field result display ("Format" column, see ["Signal Field"](#) on page 24).

"Auto, same type as first PPDU" ("A1st")

The format of the first valid PPDU is detected and subsequent PPDU are analyzed only if they have the same format.

"Auto, individually for each PPDU" ("AI")

All PPDU are analyzed regardless of their format

"Meas only ..." ("M ...")

Only PPDU with the specified format are analyzed

"Demod all as ..." ("D ...")

All PPDU are assumed to have the specified PPDU format

SCPI command:

[SENSe:] DEMod: FORMat: BANalyze: BTYPE: AUTO: TYPE on page 138

[SENSe:] DEMod: FORMat: BANalyze on page 138

## Default WLAN Measurement (Modulation Accuracy, Flatness, Tolerance...)

**Channel Bandwidth to measure (CBW)**

Defines the channel bandwidth of the PPDU's taking part in the analysis. Depending on which standards the communicating devices are using, different PPDU formats and channel bandwidths are supported.

For details on supported PPDU formats and channel bandwidths depending on the standard see [table 4-1](#).

**Note:** The terms in brackets in the following description indicate how the setting is referred to in the Signal Field result display ("CBW" column, see ["Signal Field"](#) on page 24).

"Auto, same type as first PPDU""(A1st)"	The channel bandwidth of the first valid PPDU is detected and subsequent PPDU's are analyzed only if they have the same channel bandwidth.
"Auto, individually for each PPDU""(AI)"	All PPDU's are analyzed regardless of their channel bandwidth
"Meas only ... signal""(M ...)"	Only PPDU's with the specified channel bandwidth are analyzed
"Demod all as ... signal""(D ...)"	All PPDU's are assumed to have the specified channel bandwidth

SCPI command:

[\[SENSe:\]BANDwidth:CHANnel:AUTO:TYPE](#) on page 136

**PSDU Modulation to use (IEEE 802.11 A)**

Specifies which PSDUs are to be analyzed depending on their modulation. Only PSDUs using the selected modulation are considered in measurement analysis.

For details on supported modulation depending on the standard see [table 4-1](#).

"Auto, same type as first PPDU""(A1st)"	All PSDUs using the same modulation as the first recognized PPDU are analyzed.
"Auto, individually for each PPDU""(AI)"	All PSDUs are analyzed
"Meas only the specified PSDU Modulation""(M ...)"	Only PSDUs with the modulation specified by the "PSDU Modulation" setting are analyzed
"Demod all with specified PSDU modulation""(D ...)"	The PSDU modulation of the "PSDU Modulation" setting is used for all PSDUs.

SCPI command:

[\[SENSe:\]DEMod:FORMat:BANalyze:BTYPe:AUTO:TYPE](#) on page 138

[\[SENSe:\]DEMod:FORMat:BANalyze](#) on page 138

**PSDU Modulation (IEEE 802.11 A)**

If analysis is restricted to PSDU with a particular modulation type (see [PSDU Modulation to use \(IEEE 802.11 A\)](#)), this setting defines which type.

For details on supported modulation depending on the standard see [table 4-1](#).

SCPI command:

[\[SENSe:\]DEMod:FORMat:BANalyze](#) on page 138

**MCS Index to use (IEEE 802.11 N, AC)**

Defines the PPDU's taking part in the analysis depending on their Modulation and Coding Scheme (MCS) index.

**Note:** The terms in brackets in the following description indicate how the setting is referred to in the Signal Field result display ("MCS" column, see ["Signal Field"](#) on page 24).

"Auto, same type as first PDU:"(A1st)" All PPDU's using the MCS index identical to the first recognized PDU are analyzed.

" Auto, individually for each PDU:"(AI)" All PPDU's are analyzed

"Meas only the specified MCS:"(M ...)" Only PPDU's with the MCS index specified for the [MCS Index \(IEEE 802.11 N, AC\)](#) setting are analyzed

"Demod all with specified MCS:"(D ...)" The [MCS Index \(IEEE 802.11 N, AC\)](#) setting is used for all PPDU's.

SCPI command:

[\[SENSe:\]DEMod:FORMat:MCSindex:MODE](#) on page 140

**MCS Index (IEEE 802.11 N, AC)**

Defines the MCS index of the PPDU's taking part in the analysis manually. This field is enabled for "MCS index to use" = "Meas only the specified MCS" or "Demod all with specified MCS".

SCPI command:

[\[SENSe:\]DEMod:FORMat:MCSindex](#) on page 140

**Nsts to use (IEEE 802.11 AC)**

Defines the the PPDU's taking part in the analysis depending on their Nsts.

**Note:** The terms in brackets in the following description indicate how the setting is referred to in the "Signal Field" result display ("NSTS" column, see ["Signal Field"](#) on page 24).

"Auto, same type as first PDU:"(A1st)" All PPDU's using the Nsts identical to the first recognized PDU are analyzed.

" Auto, individually for each PDU:"(AI)" All PPDU's are analyzed

## Default WLAN Measurement (Modulation Accuracy, Flatness, Tolerance...)

"Meas only the specified Nsts""(M ...)" Only PPDUs with the Nsts specified for the [Nsts \(IEEE 802.11 AC\)](#) setting are analyzed

"Demod all with specified Nsts""(D ...)" The [Nsts \(IEEE 802.11 AC\)](#) setting is used for all PPDUs.

SCPI command:

[\[SENSe:\]DEMod:FORMat:NSTSiNdex:MODE](#) on page 141

### Nsts (IEEE 802.11 AC)

Defines the Nsts of the PPDUs taking part in the analysis. This field is enabled for [Nsts to use \(IEEE 802.11 AC\)](#) = "Meas only the specified Nsts" or "Demod all with specified Nsts".

SCPI command:

[\[SENSe:\]DEMod:FORMat:NSTSiNdex](#) on page 141

### STBC Field (IEEE 802.11 AC,N)

Defines the PPDUs taking part in the analysis according to the Space-Time Block Coding (STBC) field content.

**Note:** The terms in brackets in the following description indicate how the setting is referred to in the Signal Field result display ("STBC" column, see ["Signal Field"](#) on page 24).

"Auto, same type as first PDU""(A1st)" All PPDUs using a STBC field content identical to the first recognized PDU are analyzed.

"Auto, individually for each PDU""(AI)" All PPDUs are analyzed.

"Meas only if STBC field = 1 (+1 Stream)""(M1)" (IEEE 802.11N) Only PPDUs with the specified STBC field content are analyzed.

"Meas only if STBC field = 2 (+2 Stream)""(M2)" (IEEE 802.11N) Only PPDUs with the specified STBC field content are analyzed.

"Demod all as STBC field = 1""(D1)"(IEEE 802.11N) All PPDUs are analyzed assuming the specified STBC field content.



## Default WLAN Measurement (Modulation Accuracy, Flatness, Tolerance...)

"Demod all as STBC field = 2""(D2)"(IEEE 802.11N) All PPDUs are analyzed assuming the specified STBC field content.

"Meas only if STBC = 1 (Nsts = 2Nss)""(M1)"(IEEE 802.11AC) Only PPDUs with the specified STBC field content are analyzed.

"Demod all as STBC = 1 (Nsts = 2Nss)""(D1)"(IEEE 802.11AC) All PPDUs are analyzed assuming the specified STBC field content.

SCPI command:

[CONFigure:WLAN:STBC:AUTO:TYPE](#) on page 136

**Extension Spatial Streams (sounding) (IEEE 802.11 N)**

Defines the PPDUs taking part in the analysis according to the Ness field content.

**Note:** The terms in brackets in the following description indicate how the setting is referred to in the Signal Field result display ("NESS" column, see ["Signal Field"](#) on page 24).

"Auto, same type as first PDU""(A1st)" All PPDUs using a Ness value identical to the first recognized PDU are analyzed.

"Auto, individually for each PDU""(AI)" All PPDUs are analyzed.

"Meas only if Ness = <x>""(M ...)" Only PPDUs with the specified Ness value are analyzed.

"Demod all as Ness = <x>" All PPDUs are analyzed assuming the specified Ness value.

SCPI command:

[CONFigure:WLAN:EXTension:AUTO:TYPE](#) on page 133

**Table info overview (IEEE 802.11 N, AC)**

Depending on the selected channel bandwidth, MCS index or NSS (STBC), the relevant information from the modulation and coding scheme (MCS) as defined in the WLAN 802.11 standard is displayed here. This information is for reference only, for example so you can determine the required data rate.

**Guard Interval Length (IEEE 802.11 N, AC)**

Defines the PPDUs taking part in the analysis depending on the guard interval length.

## Default WLAN Measurement (Modulation Accuracy, Flatness, Tolerance...)

**Note:** The terms in brackets in the following description indicate how the setting is referred to in the Signal Field result display ("GI" column, see "Signal Field" on page 24).

"Auto, same type as first PDU""(A1st)" All PPDUs using the guard interval length identical to the first recognized PDU are analyzed.

"Auto, individually for each PDU""(AI)" All PPDUs are analyzed.

"Meas only Short""(MS)" Only PPDUs with short guard interval length are analyzed.

"Meas only Long""(ML)" Only PPDUs with long guard interval length are analyzed.

"Demod all as short""(DS)" All PPDUs are demodulated assuming short guard interval length.

"Demod all as long""(DL)" All PPDUs are demodulated assuming long guard interval length.

SCPI command:

[CONFigure:WLAN:GTIME:AUTO](#) on page 134

[CONFigure:WLAN:GTIME:AUTO:TYPE](#) on page 134

[CONFigure:WLAN:GTIME:SElect](#) on page 135

### 5.3.9 Evaluation Range

The evaluation range defines which objects the result displays are based on.

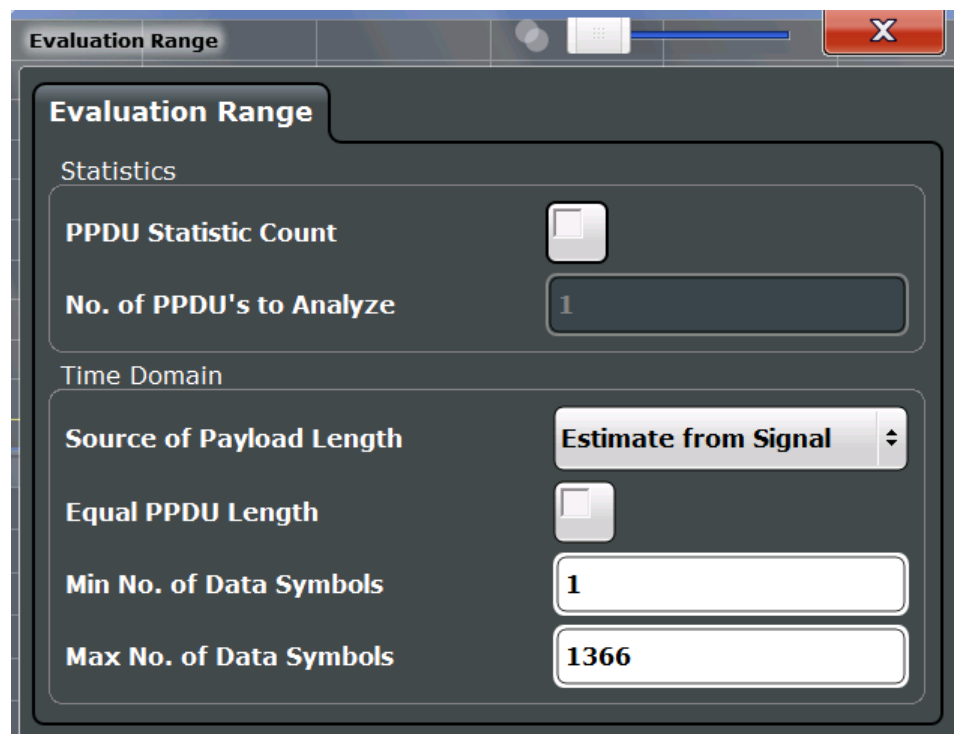

## Default WLAN Measurement (Modulation Accuracy, Flatness, Tolerance...)

PPDU Statistic Count / No of PPDU's to Analyze.....	83
Source of Payload Length (IEEE811.02 AC, N).....	83
Equal PPDU Length.....	83
No. of Data Symbols.....	83

**PPDU Statistic Count / No of PPDU's to Analyze**

If the statistic count is enabled, the specified number of PPDU's is taken into consideration for the statistical evaluation (maximally the number of PPDU's detected in the current capture buffer).

If disabled, all valid PPDU's in the current capture buffer are considered. Note that in this case, the number of PPDU's contributing to the current results may vary extremely.

SCPI command:

[SENSe:]BURSt:COUNT:STATe on page 143

[SENSe:]BURSt:COUNT on page 143

**Source of Payload Length (IEEE811.02 AC, N)**

Defines which signal source is used to determine the payload length of a PPDU.

"L-Signal"(IEEE811.02 AC)

Determines the length of the L signal

"HT-Signal"(IEEE811.02 N)

Determines the length of the HT signal

"Estimate from signal"

Uses an estimated length

SCPI command:

CONFigure:WLAN:PAYLoad:LENGth:SRC on page 142

**Equal PPDU Length**

If enabled, only PPDU's with the specified [No. of Data Symbols](#) are considered for measurement analysis.

If disabled, a maximum and minimum [No. of Data Symbols](#) can be defined and all PPDU's whose length is within this range are considered.

SCPI command:

[SENSe:]DEMod:FORMat:BANalyze:SYMBols:EQUal on page 144

**No. of Data Symbols**

If the [Equal PPDU Length](#) setting is enabled, the number of data symbols defines the exact length a PPDU must have to be considered for analysis.

If the [Equal PPDU Length](#) setting is disabled, you can define the minimum and maximum number of data symbols a PPDU must contain to be considered in measurement analysis.

SCPI command:

[SENSe:]DEMod:FORMat:BANalyze:SYMBols:MIN on page 144

[SENSe:]DEMod:FORMat:BANalyze:SYMBols:MAX on page 144

### 5.3.10 Result Configuration

You can configure which results are displayed in Result Summary displays (see "[Result Summary Detailed](#)" on page 22 and "[Result Summary Global](#)" on page 24). However, the results are always *calculated*, regardless of their visibility on the screen.

The "Result Configuration" softkey in the main WLAN menu opens the "Result Configuration" dialog box. This softkey is only available if a window with a "Result Summary Detailed" or "Result Summary Global" result display is displayed. This window must be focused or you must select it from the "Specifics for" selection list in the "Overview".

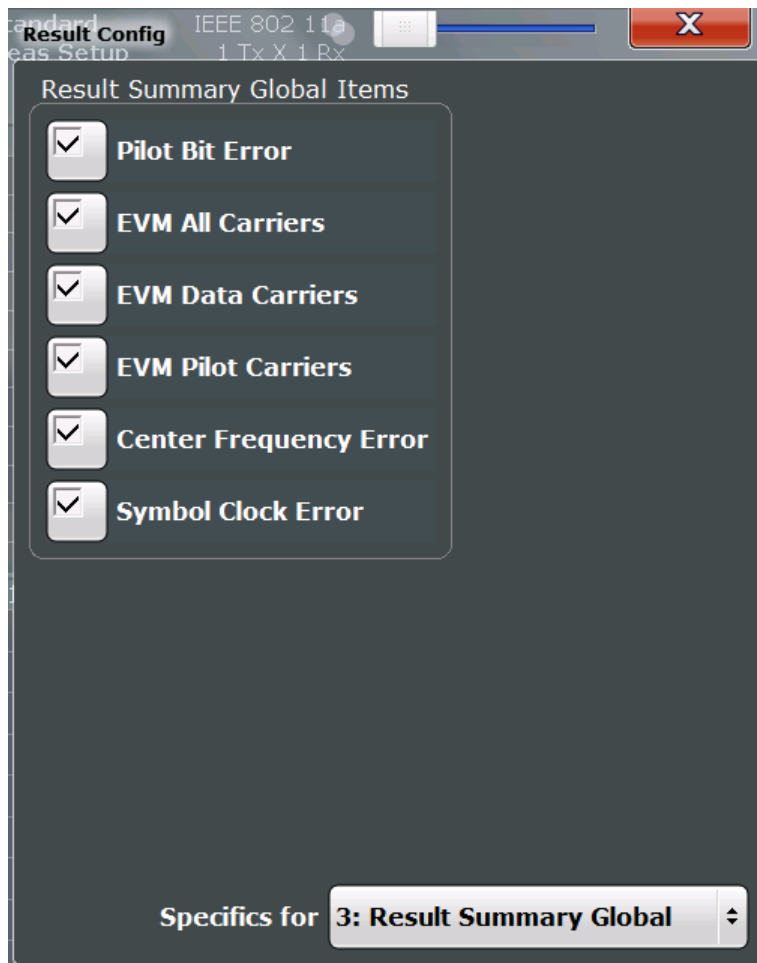

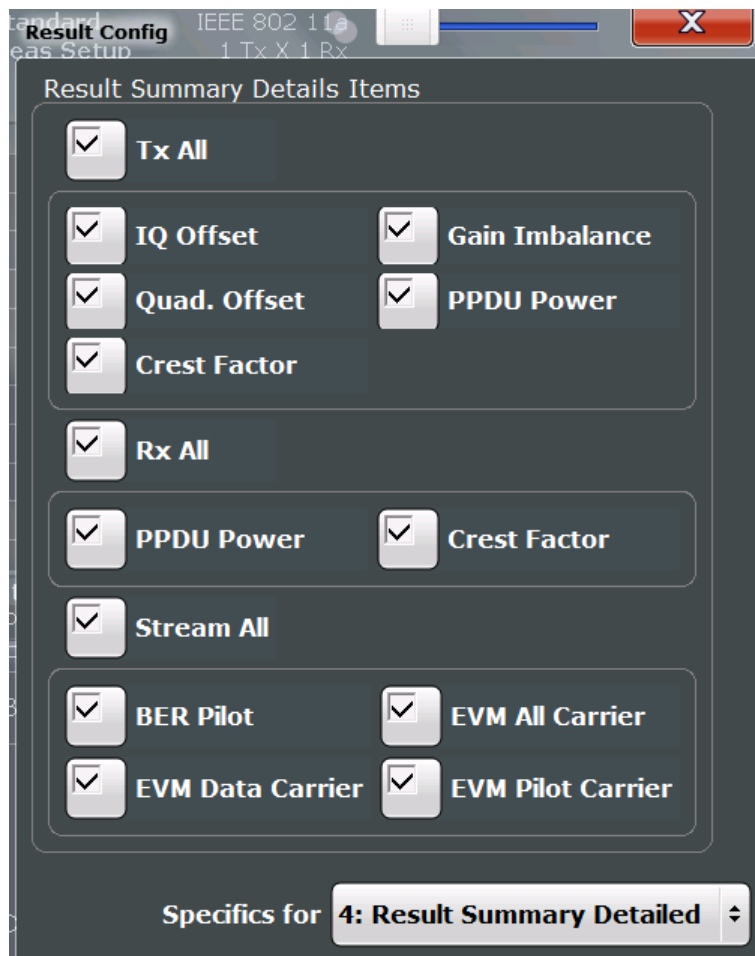
**SCPI command:**

`DISPlay[:WINDow<n>]:TABLE:ITEM` on page 158

**5.3.11 Automatic Settings**

Some settings can be adjusted by the R&S FSW automatically according to the current measurement settings and signal characteristics.

To activate the automatic adjustment of a setting, select the corresponding function in the AUTO SET menu or in the configuration dialog box for the setting, where available.

<a href="#">Setting the Reference Level Automatically (Auto Level)</a> .....	86
<a href="#">Resetting the Automatic Measurement Time (Meastime Auto)</a> .....	86
<a href="#">Changing the Automatic Measurement Time (Meastime Manual)</a> .....	86
<a href="#">Upper Level Hysteresis</a> .....	86
<a href="#">Lower Level Hysteresis</a> .....	86

**Setting the Reference Level Automatically (Auto Level)**

Automatically determines the optimal reference level for the current input data. At the same time, the internal attenuators and the preamplifier are adjusted so the signal-to-noise ratio is optimized, while signal compression, clipping and overload conditions are minimized.

In order to do so, a level measurement is performed to determine the optimal reference level.

You can change the measurement time for the level measurement if necessary (see "[Changing the Automatic Measurement Time \(Meastime Manual\)](#)" on page 86).

SCPI command:

`[SENSe:]ADJust:LEVel` on page 149

**Resetting the Automatic Measurement Time (Meastime Auto)**

Resets the measurement duration for automatic settings to the default value.

SCPI command:

`[SENSe:]ADJust:CONFigure:DURation:MODE` on page 148

**Changing the Automatic Measurement Time (Meastime Manual)**

This function allows you to change the measurement duration for automatic setting adjustments. Enter the value in seconds.

SCPI command:

`[SENSe:]ADJust:CONFigure:DURation:MODE` on page 148

`[SENSe:]ADJust:CONFigure:DURation` on page 148

**Upper Level Hysteresis**

When the reference level is adjusted automatically using the [Setting the Reference Level Automatically \(Auto Level\)](#) function, the internal attenuators and the preamplifier are also adjusted. In order to avoid frequent adaptation due to small changes in the input signal, you can define a hysteresis. This setting defines an upper threshold the signal must exceed (compared to the last measurement) before the reference level is adapted automatically.

SCPI command:

`[SENSe:]ADJust:CONFigure:HYSTeresis:UPPer` on page 149

**Lower Level Hysteresis**

When the reference level is adjusted automatically using the [Setting the Reference Level Automatically \(Auto Level\)](#) function, the internal attenuators and the preamplifier are also adjusted. In order to avoid frequent adaptation due to small changes in the input signal, you can define a hysteresis. This setting defines a lower threshold the signal must fall below (compared to the last measurement) before the reference level is adapted automatically.

SCPI command:

`[SENSe:]ADJust:CONFigure:HYSTeresis:LOWer` on page 149

### 5.3.12 Sweep Settings

The sweep settings define how the data is measured.

Sweep Count.....	87
Continuous Sweep/RUN CONT.....	87
Single Sweep/ RUN SINGLE.....	87
Continue Single Sweep.....	88

#### Sweep Count

This setting is currently ignored. For statistical evaluation see "[PPDU Statistic Count / No of PPDUs to Analyze](#)" on page 83.

#### Continuous Sweep/RUN CONT

While the measurement is running, the "Continuous Sweep" softkey and the RUN CONT key are highlighted. The running measurement can be aborted by selecting the highlighted softkey or key again. The results are not deleted until a new measurement is started.

**Note:** Sequencer. If the Sequencer is active, the "Continuous Sweep" softkey only controls the sweep mode for the currently selected channel; however, the sweep mode only has an effect the next time the Sequencer activates that channel, and only for a channel-defined sequence. In this case, a channel in continuous sweep mode is swept repeatedly. Furthermore, the RUN CONT key on the front panel controls the Sequencer, not individual sweeps. RUN CONT starts the Sequencer in continuous mode.

SCPI command:

[INITiate:CONTInuous](#) on page 161

#### Single Sweep/ RUN SINGLE

While the measurement is running, the "Single Sweep" softkey and the RUN SINGLE key are highlighted. The running measurement can be aborted by selecting the highlighted softkey or key again.

**Note:** Sequencer. If the Sequencer is active, the "Single Sweep" softkey only controls the sweep mode for the currently selected channel; however, the sweep mode only has an effect the next time the Sequencer activates that channel, and only for a channel-defined sequence. In this case, a channel in single sweep mode is swept only once by the Sequencer.

Furthermore, the RUN SINGLE key on the front panel controls the Sequencer, not individual sweeps. RUN SINGLE starts the Sequencer in single mode.

If the Sequencer is off, only the evaluation for the currently displayed measurement channel is updated.

SCPI command:

[INITiate\[:IMMEDIATE\]](#) on page 161

**Continue Single Sweep**

While the measurement is running, the "Continue Single Sweep" softkey and the RUN SINGLE key are highlighted. The running measurement can be aborted by selecting the highlighted softkey or key again.

SCPI command:

`INITiate:CONMeas` on page 160

**5.3.13 Import/Export Functions**

The following import and export functions are available via softkeys in the "Save/Recall" menu which is displayed when you select the "Save" or "Open" icon in the toolbar.



For a description of the other functions in the "Save/Recall" menu see the R&S FSW User Manual.

Export.....	88
L IQ Export.....	88
Import.....	88
L IQ Import.....	88

**Export**

Opens a submenu to configure data export.

**IQ Export ← Export**

Opens a file selection dialog box to select an export file to which the IQ data will be stored. This function is only available in single sweep mode, and only in applications that process I/Q data, such as the I/Q Analyzer or optional applications.

For details see [chapter 4.5.2, "Importing and Exporting I/Q Data"](#), on page 45.

SCPI command:

`MMEMemory:STORe:IQ:STATe` on page 186

**Import**

Provides functions to import data.

**IQ Import ← Import**

Opens a file selection dialog box to select an import file that contains IQ data. This function is only available in single sweep mode and only in applications that process I/Q data, such as the I/Q Analyzer or optional applications.

Note that the I/Q data must have a specific format as described in [chapter A.2, "Reference: I/Q Data File Export Format \(iq.tar\)"](#), on page 203.

For details see [chapter 4.5.2, "Importing and Exporting I/Q Data"](#), on page 45.

SCPI command:

`MMEMemory:LOAD:IQ:STATe` on page 186



## 5.4 RF (Frequency Domain) Measurements

When you activate a measurement channel in WLAN mode, a default WLAN measurement of the input signal is started automatically (see [chapter 3.1, "Default WLAN Measurement \(Modulation Accuracy, Flatness and Tolerance\)"](#), on page 11). However, some parameters specified in the WLAN 802.11 standard require a better signal-to-noise level or a smaller bandwidth filter than the default measurement on I/Q data provides and must be determined in separate measurements based on RF data (see [chapter 3.2, "Measurements on RF Data"](#), on page 28). In these measurements, demodulation is not performed.

### Selecting the measurement type

WLAN measurements require a special operating mode on the R&S FSW, which you activate using the MODE key on the front panel.

- ▶ To select an RF measurement type, do one of the following:
  - Tap the "Overview" softkey. In the "Overview", tap the "Select Measurement" button. Select the required measurement.
  - Press the MEAS key on the front panel. In the "Select Measurement" dialog box, select the required measurement.

The R&S FSW WLAN application uses the functionality of the FSW base system (Spectrum application) to perform the WLAN measurements on RF data. Some parameters are set automatically according to the WLAN 802.11 standard the first time a measurement is selected (since the last PRESET operation). These parameters can be changed, but are not reset automatically the next time you re-enter the measurement. Refer to the description of each measurement type for details.

The main measurement configuration menus for the WLAN measurements on RF data are identical to the Spectrum application.

For details refer to "Measurements" in the R&S FSW User Manual.

The measurement-specific settings for the following measurements are available via the "Overview".

- [Channel Power \(ACLR\) Measurements](#).....89
- [Spectrum Emission Mask](#).....90
- [Occupied Bandwidth](#).....91
- [CCDF](#).....92

### 5.4.1 Channel Power (ACLR) Measurements

The Adjacent Channel Power measurement analyzes the power of the TX channel and the power of adjacent and alternate channels on the left and right side of the TX channel. The number of TX channels and adjacent channels can be modified as well as the band class. The bandwidth and power of the TX channel and the bandwidth, spacing and power of the adjacent and alternate channels are displayed in the Result Summary.

Channel Power ACLR measurements are performed as in the Spectrum application with the following predefined settings according to WLAN specifications (adjacent channel leakage ratio).

**Table 5-2: Predefined settings for WLAN ACLR Channel Power measurements**

Setting	Default value
ACLR Standard	same as defined in WLAN signal description (see "Standard" on page 56)
Number of adjacent channels	3
Reference channel	Max power Tx channel
Channel bandwidth	20 MHz

For further details about the ACLR measurements refer to "Measuring Channel Power and Adjacent-Channel Power" in the R&S FSW User Manual.

To restore adapted measurement parameters, the following parameters are saved on exiting and are restored on re-entering this measurement:

- Reference level and reference level offset
- RBW, VBW
- Sweep time
- Span
- Number of adjacent channels
- Fast ACLR mode

The main measurement menus for the RF measurements are identical to the Spectrum application.

## 5.4.2 Spectrum Emission Mask

The Spectrum Emission Mask measurement shows the quality of the measured signal by comparing the power values in the frequency range near the carrier against a spectral mask that is defined by the WLAN 802.11 specifications. The limits depend on the selected power class. Thus, the performance of the DUT can be tested and the emissions and their distance to the limit are identified.



Note that the WLAN standard does not distinguish between spurious and spectral emissions.

The Result Summary contains a peak list with the values for the largest spectral emissions including their frequency and power.

The WLAN application performs the SEM measurement as in the Spectrum application with the following settings:

**Table 5-3: Predefined settings for WLAN SEM measurements**

Setting	Default value
Number of ranges	3
Frequency Span	+/- 12.75 MHz
Fast SEM	OFF
Sweep time	140 $\mu$ s
RBW	30 kHz
Power reference type	Channel Power
Tx Bandwidth	3.84 MHz
Number of power classes	1

For further details about the Spectrum Emission Mask measurements refer to "Spectrum Emission Mask Measurement" in the R&S FSW User Manual.

To restore adapted measurement parameters, the following parameters are saved on exiting and are restored on re-entering this measurement:

- Reference level and reference level offset
- Sweep time
- Span

The main measurement menus for the RF measurements are identical to the Spectrum application.

### 5.4.3 Occupied Bandwidth

The Occupied Bandwidth measurement is performed as in the Spectrum application with default settings.

**Table 5-4: Predefined settings for WLAN OBW measurements**

Setting	Default value
% Power Bandwidth	99 %
Channel bandwidth	3.84 MHz

The Occupied Bandwidth measurement determines the bandwidth that the signal occupies. The occupied bandwidth is defined as the bandwidth in which – in default settings – 99 % of the total signal power is to be found. The percentage of the signal power to be included in the bandwidth measurement can be changed.

For further details about the Occupied Bandwidth measurements refer to "Measuring the Occupied Bandwidth" in the R&S FSW User Manual.

To restore adapted measurement parameters, the following parameters are saved on exiting and are restored on re-entering this measurement:

- Reference level and reference level offset
- RBW, VBW

- Sweep time
- Span

#### 5.4.4 CCDF

The CCDF measurement determines the distribution of the signal amplitudes (complementary cumulative distribution function). The CCDF and the Crest factor are displayed. For the purposes of this measurement, a signal section of user-definable length is recorded continuously in zero span, and the distribution of the signal amplitudes is evaluated.

The measurement is useful to determine errors of linear amplifiers. The crest factor is defined as the ratio of the peak power and the mean power. The Result Summary displays the number of included samples, the mean and peak power and the crest factor.

The CCDF measurement is performed as in the Spectrum application with the following settings:

**Table 5-5: Predefined settings for WLAN CCDF measurements**

Setting	Default value
CCDF	Active on trace 1
Analysis bandwidth	10 MHz
Number of samples	62500
Detector	Sample

For further details about the CCDF measurements refer to "Statistical Measurements" in the R&S FSW User Manual.

To restore adapted measurement parameters, the following parameters are saved on exiting and are restored on re-entering this measurement:

- Reference level and reference level offset
- Analysis bandwidth
- Number of samples

## 6 Analysis

General result analysis settings concerning the trace and markers etc. are currently not available for the standard WLAN measurements. Only one (Clear/Write) trace and one marker are available for these measurements.



### Analysis of RF Measurements

General result analysis settings concerning the trace, markers, lines etc. for RF measurements are identical to the analysis functions in the Spectrum application except for some special marker functions and spectrograms, which are not available in the WLAN application.

For details see the "Common Analysis and Display Functions" chapter in the R&S FSW User Manual.

---

The remote commands required to perform these tasks are described in [chapter 9.9, "Analysis"](#), on page 187.

## 7 How to Perform Measurements in the WLAN Application

The following step-by-step instructions demonstrate how to perform measurements in the R&S FSW WLAN application. The following tasks are described:

- ["How to determine modulation accuracy, flatness and tolerance parameters for WLAN signals"](#) on page 94
- ["How to determine the OBW, SEM, ACLR or CCDF for WLAN signals"](#) on page 95

### How to determine modulation accuracy, flatness and tolerance parameters for WLAN signals

1. Press the MODE key on the front panel of the R&S FSW.  
A dialog box opens that contains all operating modes and applications currently available on your R&S FSW.

2. Select the "WLAN" item.



The R&S FSW opens a new measurement channel for the WLAN application.

3. Select the "Overview" softkey to display the "Overview" for a WLAN measurement.
4. Select the "Signal Description" button to define the digital standard to be used.
5. Select the "Input/Frontend" button and then the "Frequency" tab to define the input signal's center frequency.  
The reference level is adapted automatically.
6. Select the "Signal Capture" button to define how much and which data to capture from the input signal.
7. To define a particular starting point for the FFT or to improve the measurement speed for signals with a low duty cycle, select the "Synchronization/OFDM-Demod." button and set the required parameters.
8. Select the "Tracking/Channel Estimation" button to define how the data channels are to be estimated and which distortions will be compensated for.
9. Select the "Demod" button to provide information on the modulated signal and how the PPDU's detected in the capture buffer are to be demodulated.
10. Select the "Evaluation Range" button to define which data in the capture buffer you want to analyze.
11. Select the "Display Config" button and select the displays that are of interest to you (up to 16).

Arrange them on the display to suit your preferences.

12. Exit the SmartGrid mode.
13. Start a new sweep with the defined settings.
  - To perform a single sweep measurement, press the RUN SINGLE hardkey.
  - To perform a continuous sweep measurement, press the RUN CONT hardkey.

Measurement results are updated once the measurement has completed.

#### **How to determine the OBW, SEM, ACLR or CCDF for WLAN signals**

1. Press the MODE key on the front panel and select the "WLAN" application.  
The R&S FSW opens a new measurement channel for the WLAN application. I/Q data acquisition is performed by default.
2. Select the required measurement:
  - a) Press the MEAS key on the front panel.
  - b) In the "Select Measurement" dialog box, select the required measurement.The selected measurement is activated with the default settings for WLAN immediately.
3. If necessary, adapt the settings as described for the individual measurements in the R&S FSW User Manual.
4. Select the "Display Config" button and select the evaluation methods that are of interest to you.  
Arrange them on the display to suit your preferences.
5. Exit the SmartGrid mode and select the "Overview" softkey to display the "Overview" again.
6. Select the "Analysis" button in the "Overview" to make use of the advanced analysis functions in the result displays.
  - Configure a trace to display the average over a series of sweeps; if necessary, increase the "Sweep Count" in the "Sweep" settings.
  - Configure markers and delta markers to determine deviations and offsets within the evaluated signal.
  - Use special marker functions to calculate noise or a peak list.
  - Configure a limit check to detect excessive deviations.
7. Optionally, export the trace data of the graphical evaluation results to a file.
  - a) In the "Traces" tab of the "Analysis" dialog box, switch to the "Trace Export" tab.
  - b) Select "Export Trace to ASCII File".
  - c) Define a file name and storage location and select "OK".

## 8 Optimizing and Troubleshooting the Measurement

- [Optimizing the Measurement Results](#).....96
- [Error Messages and Warnings](#).....97

### 8.1 Optimizing the Measurement Results

If the results do not meet your expectations, try the following methods to optimize the measurement.

- [Improving Performance](#) .....96
- [Improving Channel Estimation and EVM Accuracy](#).....96

#### 8.1.1 Improving Performance

##### Performing a coarse burst search

For signals with **low duty cycle rates**, enable the "Power Interval Search" for synchronization (see "[Power Interval Search](#)" on page 73). In this case, the R&S FSW WLAN application initially performs a coarse burst search on the input signal in which increases in the power vs time trace are detected. Further time-consuming processing is then only performed where bursts are assumed. This improves the measurement speed.

However, for signals in which the PPDU power levels differ significantly, this option should be disabled as otherwise some PPDUs may not be detected.

#### 8.1.2 Improving Channel Estimation and EVM Accuracy

The channels in the WLAN signal are estimated based on the expected input signal description and the information provided by the PPDUs themselves. The more accurate the channel estimation, the more accurate the EVM based on these channels can be calculated.

##### Increasing the basis for channel estimation

The more information that can be used to estimate the channels, the more accurate the results. For measurements that need not be performed strictly according to the WLAN 802.11 standard, set the "Channel Estimation Range" to "Payload" (see "[Channel Estimation Range](#)" on page 75).

The channel estimation is performed in the preamble and the payload. The EVM results can be calculated more accurately.



### Accounting for phase drift in the EVM

According to the WLAN 802.11 standards, the common phase drift must be estimated and compensated from the pilots. Thus, these deviations are not included in the EVM. To include the phase drift, disable "Phase Tracking" (see ["Phase Tracking"](#) on page 75).

### Analyzing time jitter

Normally, a symbol-wise timing jitter is negligible and not required by the IEEE 802.11a measurement standard [6], and thus not considered in channel estimation. However, there may be situations where the timing drift has to be taken into account.

However, to analyze the time jitter per symbol, enable "Timing Tracking" (see ["Timing Error Tracking"](#) on page 75).

### Compensating for non-standard-conform pilot sequences

In case the pilot generation algorithm of the device under test (DUT) has a problem, the non-standard-conform pilot sequence might affect the measurement results, or the WLAN application might not synchronize at all onto the signal generated by the DUT.

In this case, set the "Pilots for Tracking" to "Detected" (see ["Pilots for Tracking"](#) on page 75), so that the pilot sequence detected in the signal is used instead of the sequence defined by the standard.

However, if the pilot sequence generated by the DUT is correct, it is recommended that you use the "According to Standard" setting because it generates more accurate measurement results.

## 8.2 Error Messages and Warnings

The following messages are displayed in the status bar in case of errors.

### Results contribute to overall results despite inconsistencies:

#### **"Info: Comparison between HT-SIG Payload Length and Estimated Payload Length not performed due to insufficient SNR"**

The R&S FSW-K91 application compares the HT-SIG length against the length estimated from the PPDU power profile. If the two values do not match, the corresponding entry is highlighted orange. If the signal quality is very bad, this comparison is suppressed and the message above is shown.

#### **"Warning: HT-SIG of PPDU was not evaluated"**

Decoding of the HT-SIG was not possible because there was not enough data in the Capture Memory (potential PPDU truncation).

#### **"Warning: Mismatch between HT-SIG and estimated (SNR+Power) PPDU length"**

The HT-SIG length and the length estimated by the R&S FSW application (from the PPDU power profile) are different.

**"Warning: Physical Channel estimation impossible / Phy Chan results not available  
Possible reasons: channel matrix not square or singular to working precision"**

The Physical Channel results could not be calculated for one or both of the following reasons:

- The spatial mapping can not be applied due to a rectangular mapping matrix (the number of space time streams is not equal to the number of transmit antennas).
- The spatial mapping matrices are singular to working precision.

**PPDUs are dismissed due to inconsistencies****"Hint: PPDU requires at least one payload symbol"**

Currently at least one payload symbol is required in order to successfully analyze the PPDU. Null data packet (NDP) sounding PPDUs will generate this message.

**"Hint: PPDU dismissed due to a mismatch with the PPDU format to be analyzed"**

The properties causing the mismatches for this PPDU are highlighted.

**"Hint: PPDU dismissed due to truncation"**

The first or the last PPDU was truncated during the signal capture process, for example.

**"Hint: PPDU dismissed due to HT-SIG inconsistencies"**

One or more of the following HT-SIG decoding results are outside of specified range: MCS index, Number of additional STBC streams, Number of space time streams (derived from MCS and STBC), CRC Check failed, Non zero tail bits.

**"Hint: PPDU dismissed because payload channel estimation was not possible"**

The payload based channel estimation was not possible because the channel matrix is singular to working precision.

**"Hint: Channel matrix singular to working precision"**

Channel equalizing (for PPDU Length Detection, fully and user compensated measurement signal) is not possible because the estimated channel matrix is singular to working precision.

## 9 Remote Commands for WLAN Measurements

The following commands are required to perform measurements in the R&S FSW WLAN application in a remote environment. It assumes that the R&S FSW has already been set up for remote operation in a network as described in the base unit manual (*How to Set Up a Network and Remote Control*).

### Common Suffixes

For the description of the remote commands in the WLAN application, the following common suffixes are used:

**Table 9-1: Common suffixes for WLAN measurements on I/Q data**

Suffix	Value range	Description
<n>	1..16	Window
<k>	1..8	Limit
<t>	1	Trace
<m>	1..4	Marker

**Table 9-2: Common suffixes for measurements on RF data**

Suffix	Value range	Description
<n>	1..16	Window
<t>	1..6	Trace
<m>	1..16	Marker
<ch>	1..18 (TX channel) 1..11 (ALternate or ADJacent channel)	Channel
<k>	1..8	Limit line



Note that basic tasks that are independent of the application are not described here. For a description of such tasks, see the R&S FSW User Manual.

In particular, this includes:

- Managing Settings and Results, i.e. storing and loading settings and result data
- Basic instrument configuration, e.g. checking the system configuration, customizing the screen layout, or configuring networks and remote operation
- Using the common status registers

After an introduction to SCPI commands, the following tasks specific to the WLAN application are described here:

• Introduction.....	100
• Activating WLAN Measurements.....	104
• Selecting a Measurement.....	107
• Configuring the Default WLAN Measurement (Modulation Accuracy, Flatness and Tolerance).....	111
• Configuring Measurements on RF Data from WLAN Signals.....	150
• Configuring the Result Display.....	150
• Starting a Measurement.....	159
• Retrieving Results.....	164
• Analysis.....	187
• Status Registers.....	190
• Commands for Compatibility.....	194
• Programming Examples (R&S FSW-K91).....	196

## 9.1 Introduction

Commands are program messages that a controller (e.g. a PC) sends to the instrument or software. They operate its functions ('setting commands' or 'events') and request information ('query commands'). Some commands can only be used in one way, others work in two ways (setting and query). If not indicated otherwise, the commands can be used for settings and queries.

The syntax of a SCPI command consists of a header and, in most cases, one or more parameters. To use a command as a query, you have to append a question mark after the last header element, even if the command contains a parameter.

A header contains one or more keywords, separated by a colon. Header and parameters are separated by a "white space" (ASCII code 0 to 9, 11 to 32 decimal, e.g. blank). If there is more than one parameter for a command, these are separated by a comma from one another.

Only the most important characteristics that you need to know when working with SCPI commands are described here. For a more complete description, refer to the User Manual of the R&S FSW.



### Remote command examples

Note that some remote command examples mentioned in this general introduction may not be supported by this particular application.

### 9.1.1 Long and Short Form

The keywords have a long and a short form. You can use either the long or the short form, but no other abbreviations of the keywords.

The short form is emphasized in upper case letters. Note however, that this emphasis only serves the purpose to distinguish the short from the long form in the manual. For the instrument, the case does not matter.

**Example:**

`SENSe:FREQuency:CENTer` is the same as `SENS:FREQ:CENT`.

### 9.1.2 Numeric Suffixes

Some keywords have a numeric suffix if the command can be applied to multiple instances of an object. In that case, the suffix selects a particular instance (e.g. a measurement window).

Numeric suffixes are indicated by angular brackets (<n>) next to the keyword.

If you don't quote a suffix for keywords that support one, a 1 is assumed.

**Example:**

`DISPlay[:WINDow<1...4>]:ZOOM:STATe` enables the zoom in a particular measurement window, selected by the suffix at `WINDow`.

`DISPlay:WINDow4:ZOOM:STATe ON` refers to window 4.

### 9.1.3 Optional Keywords

Some keywords are optional and are only part of the syntax because of SCPI compliance. You can include them in the header or not.

Note that if an optional keyword has a numeric suffix and you need to use the suffix, you have to include the optional keyword. Otherwise, the suffix of the missing keyword is assumed to be the value 1.

Optional keywords are emphasized with square brackets.

**Example:**

Without a numeric suffix in the optional keyword:

`[SENSe:]FREQuency:CENTer` is the same as `FREQuency:CENTer`

With a numeric suffix in the optional keyword:

`DISPlay[:WINDow<1...4>]:ZOOM:STATe`

`DISPlay:ZOOM:STATe ON` enables the zoom in window 1 (no suffix).

`DISPlay:WINDow4:ZOOM:STATe ON` enables the zoom in window 4.

### 9.1.4 Alternative Keywords

A vertical stroke indicates alternatives for a specific keyword. You can use both keywords to the same effect.

**Example:**

```
[SENSe:]BANDwidth|BWIDth[:RESolution]
```

In the short form without optional keywords, `BAND 1MHZ` would have the same effect as `BWID 1MHZ`.

## 9.1.5 SCPI Parameters

Many commands feature one or more parameters.

If a command supports more than one parameter, these are separated by a comma.

**Example:**

```
LAYout:ADD:WINDow Spectrum,LEFT,MTABLE
```

Parameters may have different forms of values.

- [Numeric Values](#).....102
- [Boolean](#).....103
- [Character Data](#).....103
- [Character Strings](#).....104
- [Block Data](#).....104

### 9.1.5.1 Numeric Values

Numeric values can be entered in any form, i.e. with sign, decimal point or exponent. In case of physical quantities, you can also add the unit. If the unit is missing, the command uses the basic unit.

**Example:**

with unit: `SENSe:FREQuency:CENTer 1GHZ`

without unit: `SENSe:FREQuency:CENTer 1E9` would also set a frequency of 1 GHz.

Values exceeding the resolution of the instrument are rounded up or down.

If the number you have entered is not supported (e.g. in case of discrete steps), the command returns an error.

Instead of a number, you can also set numeric values with a text parameter in special cases.

- **MIN/MAX**  
Defines the minimum or maximum numeric value that is supported.
- **DEF**  
Defines the default value.
- **UP/DOWN**  
Increases or decreases the numeric value by one step. The step size depends on the setting. In some cases you can customize the step size with a corresponding command.

### Querying numeric values

When you query numeric values, the system returns a number. In case of physical quantities, it applies the basic unit (e.g. Hz in case of frequencies). The number of digits after the decimal point depends on the type of numeric value.

#### Example:

Setting: `SENSe:FREQuency:CENTer 1GHZ`

Query: `SENSe:FREQuency:CENTer?` would return `1E9`

In some cases, numeric values may be returned as text.

- `INF/NINF`  
Infinity or negative infinity. Represents the numeric values `9.9E37` or `-9.9E37`.
- `NAN`  
Not a number. Represents the numeric value `9.91E37`. `NAN` is returned in case of errors.

### 9.1.5.2 Boolean

Boolean parameters represent two states. The "ON" state (logically true) is represented by "ON" or a numeric value 1. The "OFF" state (logically untrue) is represented by "OFF" or the numeric value 0.

#### Querying boolean parameters

When you query boolean parameters, the system returns either the value 1 ("ON") or the value 0 ("OFF").

#### Example:

Setting: `DISPlay:WINDow:ZOOM:STATe ON`

Query: `DISPlay:WINDow:ZOOM:STATe?` would return `1`

### 9.1.5.3 Character Data

Character data follows the syntactic rules of keywords. You can enter text using a short or a long form. For more information see [chapter 9.1.1, "Long and Short Form"](#), on page 100.

#### Querying text parameters

When you query text parameters, the system returns its short form.

#### Example:

Setting: `SENSe:BANDwidth:RESolution:TYPE NORMal`

Query: `SENSe:BANDwidth:RESolution:TYPE?` would return `NORM`

### 9.1.5.4 Character Strings

Strings are alphanumeric characters. They have to be in straight quotation marks. You can use a single quotation mark ( ' ) or a double quotation mark ( " ).

**Example:**

```
INSTRument:DELeTe 'Spectrum'
```

### 9.1.5.5 Block Data

Block data is a format which is suitable for the transmission of large amounts of data.

The ASCII character # introduces the data block. The next number indicates how many of the following digits describe the length of the data block. In the example the 4 following digits indicate the length to be 5168 bytes. The data bytes follow. During the transmission of these data bytes all end or other control signs are ignored until all bytes are transmitted. #0 specifies a data block of indefinite length. The use of the indefinite format requires a NL^END message to terminate the data block. This format is useful when the length of the transmission is not known or if speed or other considerations prevent segmentation of the data into blocks of definite length.

## 9.2 Activating WLAN Measurements

WLAN measurements require a special application on the R&S FSW (R&S FSW-K91). The measurement is started immediately with the default settings.



These are basic R&S FSW commands, listed here for your convenience.

INSTRument:CREate[:NEW].....	104
INSTRument:CREate:REPLace.....	105
INSTRument:DELeTe.....	105
INSTRument:LIST?.....	105
INSTRument:REName .....	106
INSTRument[:SELeCt].....	107
SYSTem:PRESet:CHANnel[:EXECute].....	107

### **INSTRument:CREate[:NEW] <ChannelType>, <ChannelName>**

This command adds an additional measurement channel. The number of measurement channels you can configure at the same time depends on available memory.

**Parameters:**

<ChannelType> Channel type of the new channel.  
For a list of available channel types see [table 9-3](#).



<ChannelName> String containing the name of the channel. The channel name is displayed as the tab label for the measurement channel.  
 Note: If the specified name for a new channel already exists, the default name, extended by a sequential number, is used for the new channel (see [table 9-3](#)).

**Example:** `INST:CRE SAN, 'Spectrum 2'`  
 Adds an additional spectrum display named "Spectrum 2".

#### **INSTrument:CREate:REPLace** <ChannelName1>,<ChannelType>,<ChannelName2>

This command replaces a measurement channel with another one.

##### **Parameters:**

<ChannelName1> String containing the name of the measurement channel you want to replace.

<ChannelType> Channel type of the new channel.  
 For a list of available channel types see [table 9-3](#).

<ChannelName2> String containing the name of the new channel.  
 Note: If the specified name for a new channel already exists, the default name, extended by a sequential number, is used for the new channel (see [table 9-3](#)).

**Example:** `INST:CRE:REPL 'Spectrum2', IQ, 'IQAnalyzer'`  
 Replaces the channel named 'Spectrum2' by a new measurement channel of type 'IQ Analyzer' named 'IQAnalyzer'.

#### **INSTrument:DELeTe** <ChannelName>

This command deletes a measurement channel. If you delete the last measurement channel, the default "Spectrum" channel is activated.

##### **Parameters:**

<ChannelName> String containing the name of the channel you want to delete.  
 A measurement channel must exist in order to be able delete it.

**Example:** `INST:DEL 'Spectrum4'`  
 Deletes the spectrum channel with the name 'Spectrum4'.

#### **INSTrument:LIST?**

This command queries all active measurement channels. This is useful in order to obtain the names of the existing measurement channels, which are required in order to replace or delete the channels.

##### **Return values:**

<ChannelType>,  
 <ChannelName> For each channel, the command returns the channel type and channel name (see [table 9-3](#)).

Tip: to change the channel name, use the [INSTrument:REName](#) command.

**Example:** `INST:LIST?`  
 Result for 3 measurement channels:  
 'ADEM', 'Analog Demod', 'IQ', 'IQ  
 Analyzer', 'SANALYZER', 'Spectrum'

**Usage:** Query only

**Table 9-3: Available measurement channel types and default channel names**

Application	<ChannelType> Parameter	Default Channel Name*)
Spectrum	SANALYZER	Spectrum
I/Q Analyzer	IQ	IQ Analyzer
Pulse (R&S FSW-K6)	PULSE	Pulse
Analog Demodulation (R&S FSW-K7)	ADEM	Analog Demod
GSM (R&S FSW-K10)	GSM	GSM
Multi-Carrier Group Delay (R&S FSW-K17)	MCGD	MC Group Delay
Noise (R&S FSW-K30)	NOISE	Noise
Phase Noise (R&S FSW-K40)	PNOISE	Phase Noise
VSA (R&S FSW-K70)	DDEM	VSA
3GPP FDD BTS (R&S FSW-K72)	BWCD	3G FDD BTS
3GPP FDD UE (R&S FSW-K73)	MWCD	3G FDD UE
cdma2000 BTS (R&S FSW-K82)	BC2K	CDMA2000 BTS
cdma2000 MS (R&S FSW-K83)	MC2K	CDMA2000 MS
1xEV-DO BTS (R&S FSW-K84)	BDO	1xEV-DO BTS
1xEV-DO MS (R&S FSW-K85)	MDO	1xEV-DO MS
WLAN (R&S FSW-K91)	WLAN	WLAN
LTE (R&S FSW-K10x)	LTE	LTE

Note: the default channel name is also listed in the table. If the specified name for a new channel already exists, the default name, extended by a sequential number, is used for the new channel.

**INSTrument:REName** <ChannelName1>, <ChannelName2>

This command renames a measurement channel.

**Parameters:**

<ChannelName1> String containing the name of the channel you want to rename.

<ChannelName2> String containing the new channel name.  
Note that you can not assign an existing channel name to a new channel; this will cause an error.

**Example:** `INST:REN 'Spectrum2', 'Spectrum3'`  
Renames the channel with the name 'Spectrum2' to 'Spectrum3'.

#### **INSTrument[:SElect] <ChannelType> | <ChannelName>**

This command activates a new measurement channel with the defined channel type, or selects an existing measurement channel with the specified name.

See also `INSTrument:CREate[:NEW]` on page 104.

For a list of available channel types see `INSTrument:LIST?` on page 105.

#### **Parameters:**

<ChannelType> Channel type of the new channel.  
For a list of available channel types see [table 9-3](#).

#### **WLAN**

WLAN option, R&S FSW-K91

<ChannelName> String containing the name of the channel.

**Example:** `INST WLAN`  
Activates a measurement channel for the WLAN application.  
`INST 'WLAN'`  
Selects the measurement channel named 'WLAN' (for example before executing further commands for that channel).

#### **SYSTem:PRESet:CHANnel[:EXECute]**

This command restores the default instrument settings in the current channel.

Use `INST:SEL` to select the channel.

**Example:** `INST 'Spectrum2'`  
Selects the channel for "Spectrum2".  
`SYST:PRES:CHAN:EXEC`  
Restores the factory default settings to the "Spectrum2" channel.

**Usage:** Event

**Manual control:** See ["Preset Channel"](#) on page 55

## 9.3 Selecting a Measurement

The following commands are required to define the measurement type in a remote environment. The selected measurement must be started explicitly (see [chapter 9.7, "Starting a Measurement"](#), on page 159)!

For details on available measurements see [chapter 3, "Measurements and Result Displays"](#), on page 11.



The default WLAN measurement captures the I/Q data from the WLAN signal using a (nearly rectangular) filter with a relatively large bandwidth. This measurement is selected when the WLAN measurement channel is activated. The commands to select a different measurement or return to the default WLAN measurement are described here.

Note that the `CONF:BURSt:<ResultType>:IMM` commands change the screen layout to display the Magnitude Capture buffer in window 1 at the top of the screen and the selected result type in window 2 below that.

Use the `LAYout` commands to change the display (see [chapter 9.6, "Configuring the Result Display"](#), on page 150).

- [Selecting the Default WLAN Measurement \(Modulation Accuracy, Flatness and Tolerance\)](#).....108
- [Selecting a Common RF Measurement for WLAN Signals](#).....110

### 9.3.1 Selecting the Default WLAN Measurement (Modulation Accuracy, Flatness and Tolerance)

Any of the following commands can be used to return to the default WLAN measurement. Each of these results are automatically determined when the default WLAN measurement is performed.



The selected measurement must be started explicitly (see [chapter 9.7, "Starting a Measurement"](#), on page 159)!

<code>CONFigure:BURSt:CONSt:CCARrier[:IMMEDIATE]</code> .....	108
<code>CONFigure:BURSt:CONSt:CSYMBOL[:IMMEDIATE]</code> .....	109
<code>CONFigure:BURSt:EVM:ECARrier[:IMMEDIATE]</code> .....	109
<code>CONFigure:BURSt:EVM:ESYMBOL[:IMMEDIATE]</code> .....	109
<code>CONFigure:BURSt:SPECTrum:FFT[:IMMEDIATE]</code> .....	109
<code>CONFigure:BURSt:SPECTrum:FLATness:SElect</code> .....	109
<code>CONFigure:BURSt:SPECTrum:FLATness[:IMMEDIATE]</code> .....	110
<code>CONFigure:BURSt:STATistics:BSTReam[:IMMEDIATE]</code> .....	110
<code>CONFigure:BURSt:STATistics:SField[:IMMEDIATE]</code> .....	110

#### **CONFigure:BURSt:CONSt:CCARrier[:IMMEDIATE]**

This remote control command configures the result display type of window 2 to be Constellation vs Carrier. Results are only displayed after a measurement is executed, e.g. using the `INITiate[:IMMEDIATE]` command.

**Manual control:** See ["Constellation vs Carrier"](#) on page 18

**CONFigure:BURSt:CONSt:CSYMBOL[:IMMEDIATE]**

This remote control command configures the result display type of window 2 to be Constellation vs Symbol. Results are only displayed after a measurement is executed, e.g. using the `INITiate[:IMMEDIATE]` command

**Manual control:** See "[Constellation](#)" on page 17

**CONFigure:BURSt:EVM:ECARrier[:IMMEDIATE]**

This remote control command configures the result display type of window 2 to be EVM vs Carrier. Results are only displayed after a measurement is executed, e.g. using the `INITiate[:IMMEDIATE]` command.

**Manual control:** See "[EVM vs Carrier](#)" on page 19

**CONFigure:BURSt:EVM:ESYMBOL[:IMMEDIATE]**

This remote control command configures the measurement type to be EVM vs Symbol. Results are only displayed after a measurement is executed, e.g. using the `INITiate[:IMMEDIATE]` command.

**Manual control:** See "[EVM vs Symbol](#)" on page 19

**CONFigure:BURSt:SPECTrum:FFT[:IMMEDIATE]**

This remote control command configures the result display type of window 2 to be FFT Spectrum. Results are only displayed after a measurement is executed, e.g. using the `INITiate[:IMMEDIATE]` command.

**Manual control:** See "[FFT Spectrum](#)" on page 20

**CONFigure:BURSt:SPECTrum:FLATness:SElect <MeasType>**

This remote control command configures result display type of window 2 to be either Spectrum Flatness or Group Delay. Results are only displayed after a measurement is executed, e.g. using the `INITiate[:IMMEDIATE]` command.

**Parameters:**

<MeasType> FLATness | GRDelay

**Example:**

```
CONF: BURS: SPEC: FLAT: SEL FLAT
```

Configures the result display of window 2 to be Spectrum Flatness.

```
CONF: BURS: SPEC: FLAT: IMM
```

Performs a default WLAN measurement. When the measurement is completed, the Spectrum Flatness results are displayed.

**Manual control:** See "[Group Delay](#)" on page 21  
See "[Spectrum Flatness](#)" on page 27

**CONFigure:BURSt:SPECTrum:FLATness[:IMMEDIATE]**

This remote control command configures the result display in window 2 to be Spectrum Flatness or Group Delay, depending on which result display was selected last using [CONFigure:BURSt:SPECTrum:FLATness:SElect](#) on page 109. Results are only displayed after a measurement is executed, e.g. using the [INITiate\[:IMMEDIATE\]](#) command.

**Example:** `CONF: BURS: SPEC: FLAT: SEL FLAT`  
 Configures the result display of window 2 to be Spectrum Flatness.  
`CONF: BURS: SPEC: FLAT: IMM`  
 Performs a default WLAN measurement. When the measurement is completed, the Spectrum Flatness results are displayed.

**Manual control:** See ["Group Delay"](#) on page 21  
 See ["Spectrum Flatness"](#) on page 27

**CONFigure:BURSt:STATistics:BSTream[:IMMEDIATE]**

This remote control command configures the result display type of window 2 to be Bitstream. Results are only displayed after a measurement is executed, e.g. using the [INITiate\[:IMMEDIATE\]](#) command.

**Manual control:** See ["Bitstream"](#) on page 17

**CONFigure:BURSt:STATistics:SField[:IMMEDIATE]**

This remote control command configures the result display type of window 2 to be Signal Field. Results are only displayed after a measurement is executed, e.g. using the [INITiate\[:IMMEDIATE\]](#) command.

**Manual control:** See ["Signal Field"](#) on page 24

### 9.3.2 Selecting a Common RF Measurement for WLAN Signals

The following commands are required to select a common RF measurement for WLAN signals in a remote environment.

For details on available measurements see [chapter 3.2, "Measurements on RF Data"](#), on page 28.



The selected measurement must be started explicitly (see [chapter 9.7, "Starting a Measurement"](#), on page 159)!

<a href="#">CONFigure:BURSt:SPECTrum:ACPR[:IMMEDIATE]</a> .....	111
<a href="#">CONFigure:BURSt:SPECTrum:MASK[:IMMEDIATE]</a> .....	111
<a href="#">CONFigure:BURSt:SPECTrum:OBWidth[:IMMEDIATE]</a> .....	111
<a href="#">CONFigure:BURSt:STATistics:CCDF[:IMMEDIATE]</a> .....	111

## Configuring the Default WLAN Measurement (Modulation Accuracy, Flatness and Tolerance)

**CONFigure:BURSt:SPECtrum:ACPR[:IMMEDIATE]**

This remote control command configures the result display in window 2 to be ACPR (adjacent channel power relative). Results are only displayed after a measurement is executed, e.g. using the `INITiate[:IMMEDIATE]` command.

**Manual control:** See "Channel Power ACLR" on page 29

**CONFigure:BURSt:SPECtrum:MASK[:IMMEDIATE]**

This remote control command configures the result display in window 2 to be Spectrum Mask. Results are only displayed after a measurement is executed, e.g. using the `INITiate[:IMMEDIATE]` command

**Manual control:** See "Spectrum Emission Mask" on page 29

**CONFigure:BURSt:SPECtrum:OBWidth[:IMMEDIATE]**

This remote control command configures the result display in window 2 to be ACPR (adjacent channel power relative). Results are only displayed after a measurement is executed, e.g. using the `INITiate[:IMMEDIATE]` command.

**Manual control:** See "Occupied Bandwidth" on page 30

**CONFigure:BURSt:STATistics:CCDF[:IMMEDIATE]**

This remote control command configures the result display in window 2 to be CCDF (conditional cumulative distribution function). Results are only displayed after a measurement is executed, e.g. using the `INITiate[:IMMEDIATE]` command.

**Manual control:** See "CCDF" on page 31

## 9.4 Configuring the Default WLAN Measurement (Modulation Accuracy, Flatness and Tolerance)

The following commands are required to configure the default WLAN measurement described in [chapter 3.1, "Default WLAN Measurement \(Modulation Accuracy, Flatness and Tolerance\)"](#), on page 11.

- [Signal Description](#).....112
- [Configuring the Data Input and Output](#).....112
- [Frontend Configuration](#).....115
- [Signal Capturing](#).....121
- [Synchronization and OFDM Demodulation](#).....130
- [Tracking and Channel Estimation](#).....131
- [Demodulation](#).....133
- [Evaluation Range](#).....142

Configuring the Default WLAN Measurement (Modulation Accuracy, Flatness and Tolerance)

- [Limits](#).....145
- [Automatic Settings](#).....148
- [Sweep Settings](#).....150

### 9.4.1 Signal Description

The signal description provides information on the expected input signal.

Useful commands for describing the WLAN signal described elsewhere:

- [\[SENSe:\]FREQuency:CENTer](#) on page 115

**Remote commands exclusive to describing the WLAN signal:**

- [CONFigure:STANdard](#).....112

---

#### **CONFigure:STANdard** <Standard>

This remote control command specifies which WLAN standard the option is configured to measure.

The availability of many commands depends on the selected standard!

#### **Parameters:**

<Standard>	0   6   8
<b>0</b>	IEEE 802.11a
<b>6</b>	IEEE 802.11n
<b>8</b>	IEEE 802.11ac
*RST:	0

**Manual control:** See "[Standard](#)" on page 56

### 9.4.2 Configuring the Data Input and Output

- [RF Input](#).....112
- [Configuring the Outputs](#).....115

#### 9.4.2.1 RF Input

- [INPut:ATTenuation:PROTection:RESet](#) .....113
- [INPut:COUPLing](#).....113
- [INPut:FILTer:HPASs\[:STATe\]](#).....113
- [INPut:FILTer:YIG\[:STATe\]](#).....113
- [INPut:IMPedance](#).....114
- [INPut:SELEct](#).....114



**INPut:ATTenuation:PROTection:RESet**

This command resets the attenuator and reconnects the RF input with the input mixer after an overload condition occurred and the protection mechanism intervened. The error status bit (bit 3 in the `STAT:QUES:POW` status register) and the `INPUT_OVLD` message in the status bar are cleared.

The command works only if the overload condition has been eliminated first.

For details on the protection mechanism see [chapter 4.5.1, "RF Input Protection"](#), on page 44.

**Usage:** Event

**INPut:COUPling <CouplingType>**

This command selects the coupling type of the RF input.

**Parameters:**

<CouplingType>      **AC**  
                          AC coupling  
                          **DC**  
                          DC coupling  
                          \*RST: AC

**Example:** `INP:COUP:DC`

**Usage:** SCPI confirmed

**Manual control:** See "[Input Coupling](#)" on page 58

**INPut:FILTer:HPASs[:STATe] <State>**

Activates an additional internal high-pass filter for RF input signals from 1 GHz to 3 GHz. This filter is used to remove the harmonics of the R&S FSW in order to measure the harmonics for a DUT, for example.

This function requires option R&S FSW-B13.

(Note: for RF input signals outside the specified range, the high-pass filter has no effect. For signals with a frequency of approximately 4 GHz upwards, the harmonics are suppressed sufficiently by the YIG filter.)

**Parameters:**

<State>                ON | OFF  
                          \*RST: OFF

**Usage:** SCPI confirmed

**Manual control:** See "[High-Pass Filter 1...3 GHz](#)" on page 58

**INPut:FILTer:YIG[:STATe] <State>**

This command turns the YIG-preselector on and off.

## Configuring the Default WLAN Measurement (Modulation Accuracy, Flatness and Tolerance)

Note the special conditions and restrictions for the YIG filter described in "[YIG-Preselector](#)" on page 58.

**Parameters:**

<State> ON | OFF  
 \*RST: ON (OFF for I/Q Analyzer, GSM and MC Group Delay measurements)

**Example:**

INP:FILT:YIG OFF  
 Deactivates the YIG-preselector.

**Manual control:**

See "[YIG-Preselector](#)" on page 58

**INPut:IMPedance** <Impedance>

This command selects the nominal input impedance of the RF input.

75  $\Omega$  should be selected if the 50  $\Omega$  input impedance is transformed to a higher impedance using a matching pad of the RAZ type (= 25  $\Omega$  in series to the input impedance of the instrument). The power loss correction value in this case is 1.76 dB = 10 log (75 $\Omega$ /50 $\Omega$ ).

**Parameters:**

<Impedance> 50 | 75  
 \*RST: 50  $\Omega$

**Example:**

INP:IMP 75

**Usage:**

SCPI confirmed

**Manual control:**

See "[Impedance](#)" on page 58

**INPut:SElect** <Source>

This command selects the signal source for measurements, i.e. it defines which connector is used to input data to the R&S FSW. If no additional options are installed, only RF input is supported.

Tip: The I/Q data to be analyzed for WLAN 802.11 can not only be measured by the WLAN application itself, it can also be imported to the application, provided it has the correct format. Furthermore, the analyzed I/Q data from the WLAN application can be exported for further analysis in external applications. See [chapter 4.5.2, "Importing and Exporting I/Q Data"](#), on page 45.

**Parameters:**

<Source> **RF**  
 Radio Frequency ("RF INPUT" connector)  
 \*RST: RF

**Manual control:**

See "[Radio Frequency State](#)" on page 58

Configuring the Default WLAN Measurement (Modulation Accuracy, Flatness and Tolerance)

### 9.4.2.2 Configuring the Outputs



Configuring trigger input/output is described in "[Configuring the Trigger Output](#)" on page 128.

[DIAGnostic<n>:SERVice:NSOource](#).....115

#### **DIAGnostic<n>:SERVice:NSOource <State>**

This command turns the 28 V supply of the BNC connector labeled NOISE SOURCE CONTROL on the front panel on and off.

For details see [chapter 4.5.3, "Input from Noise Sources"](#), on page 45.

#### **Parameters:**

<State>                    ON | OFF  
\*RST:                    OFF

**Example:**                DIAG:SERV:NSO ON

**Manual control:**        See "[Noise Source](#)" on page 59

### 9.4.3 Frontend Configuration

The following commands configure frequency, amplitude and y-axis scaling settings, which represent the "frontend" of the measurement setup.

- [Frequency](#).....115
- [Amplitude Settings](#).....117

#### 9.4.3.1 Frequency

[\[SENSe:\]FREQuency:CENTer](#).....115  
[\[SENSe:\]FREQuency:CENTer:STEP](#).....116  
[\[SENSe:\]FREQuency:CENTer:STEP:AUTO](#).....116  
[\[SENSe:\]FREQuency:OFFSet](#).....117

#### **[SENSe:]FREQuency:CENTer <Frequency>**

This command defines the center frequency.

## Configuring the Default WLAN Measurement (Modulation Accuracy, Flatness and Tolerance)

**Parameters:**

&lt;Frequency&gt;

The allowed range and  $f_{\max}$  is specified in the data sheet.**UP**Increases the center frequency by the step defined using the `[SENSe:]FREQuency:CENTer:STEP` command.**DOWN**Decreases the center frequency by the step defined using the `[SENSe:]FREQuency:CENTer:STEP` command.\*RST:  $f_{\max}/2$ 

Default unit: Hz

**Example:**

FREQ:CENT 100 MHz

FREQ:CENT:STEP 10 MHz

FREQ:CENT UP

Sets the center frequency to 110 MHz.

**Usage:**

SCPI confirmed

**Manual control:**

See "Frequency" on page 56

See "Center" on page 61

**[SENSe:]FREQuency:CENTer:STEP <StepSize>**

This command defines the center frequency step size.

You can increase or decrease the center frequency quickly in fixed steps using the `SENS:FREQ UP` AND `SENS:FREQ DOWN` commands, see `[SENSe:]FREQuency:CENTer` on page 115.

**Parameters:**

&lt;StepSize&gt;

 $f_{\max}$  is specified in the data sheet.Range: 1 to  $f_{\max}$ 

\*RST: 0.1 x span

Default unit: Hz

**Example:**

FREQ:CENT 100 MHz

FREQ:CENT:STEP 10 MHz

FREQ:CENT UP

Sets the center frequency to 110 MHz.

**Manual control:**

See "Center Frequency Stepsize" on page 62

**[SENSe:]FREQuency:CENTer:STEP:AUTO <State>**

This command couples or decouples the center frequency step size to the span.

**Parameters:**

&lt;State&gt;

ON | OFF

\*RST: ON

## Configuring the Default WLAN Measurement (Modulation Accuracy, Flatness and Tolerance)

**Example:**                    `FREQ:CENT:STEP:AUTO ON`  
 Activates the coupling of the step size to the span.

---

**[SENSe:]FREQuency:OFFSet <Offset>**

This command defines a frequency offset.

If this value is not 0 Hz, the application assumes that the input signal was frequency shifted outside the application. All results of type "frequency" will be corrected for this shift numerically by the application.

See also "[Frequency Offset](#)" on page 62.

**Parameters:**

<Offset>                    Range:     -100 GHz to 100 GHz  
                               \*RST:      0 Hz

**Example:**                    `FREQ:OFFS 1GHZ`

**Usage:**                      SCPI confirmed

**Manual control:**        See "[Frequency Offset](#)" on page 62

### 9.4.3.2 Amplitude Settings

The following commands are required to configure the amplitude settings in a remote environment.

Useful commands for amplitude settings described elsewhere:

- [INPut:COUPling](#) on page 113
- [INPut:IMPedance](#) on page 114
- [\[SENSe:\]ADJust:LEVel](#) on page 149

**Remote commands exclusive to amplitude settings:**

<a href="#">DISPlay[:WINDow&lt;n&gt;]:TRACe:Y[:SCALe]:RLEVel</a> .....	117
<a href="#">DISPlay[:WINDow&lt;n&gt;]:TRACe:Y[:SCALe]:RLEVel:OFFSet</a> .....	118
<a href="#">INPut:ATTenuation</a> .....	118
<a href="#">INPut:ATTenuation:AUTO</a> .....	118
<a href="#">INPut:EATT</a> .....	119
<a href="#">INPut:EATT:AUTO</a> .....	119
<a href="#">INPut:EATT:STATe</a> .....	119
<a href="#">INPut:GAIN[:VALue]</a> .....	120
<a href="#">INPut:GAIN:STATe</a> .....	120

---

**DISPlay[:WINDow<n>]:TRACe:Y[:SCALe]:RLEVel <ReferenceLevel>**

This command defines the reference level.

**Example:**                    `DISP:TRAC:Y:RLEV -60dBm`

**Usage:**                      SCPI confirmed

Configuring the Default WLAN Measurement (Modulation Accuracy, Flatness and Tolerance)

**Manual control:** See ["Reference Level"](#) on page 63

---

### DISPlay[:WINDow<n>]:TRACe:Y[:SCALe]:RLEVel:OFFSet <Offset>

This command defines a reference level offset.

#### Parameters:

<Offset>                    Range:        -200 dB to 200 dB  
                                  \*RST:        0dB

**Example:**                    DISP:TRAC:Y:RLEV:OFFS -10dB

**Manual control:**        See ["Reference Level"](#) on page 63  
                                  See ["Shifting the Display \(Offset\)"](#) on page 63

---

### INPut:ATTenuation <Attenuation>

This command defines the total attenuation for RF input.

If an electronic attenuator is available and active, the command defines a mechanical attenuation (see [INPut:EATT:STATE](#) on page 119).

If you set the attenuation manually, it is no longer coupled to the reference level, but the reference level is coupled to the attenuation. Thus, if the current reference level is not compatible with an attenuation that has been set manually, the command also adjusts the reference level.

This function is not available if the Digital Baseband Interface (R&S FSW-B17) is active.

#### Parameters:

<Attenuation>                Range:        see data sheet  
                                  Increment:    5 dB  
                                  \*RST:        10 dB (AUTO is set to ON)

**Example:**                    INP:ATT 30dB  
                                  Defines a 30 dB attenuation and decouples the attenuation from the reference level.

**Usage:**                        SCPI confirmed

**Manual control:**        See ["RF Attenuation"](#) on page 64  
                                  See ["Attenuation Mode / Value"](#) on page 64

---

### INPut:ATTenuation:AUTO <State>

This command couples or decouples the attenuation to the reference level. Thus, when the reference level is changed, the R&S FSW determines the signal level for optimal internal data processing and sets the required attenuation accordingly.

#### Parameters:

<State>                        ON | OFF  
                                  \*RST:        ON

Configuring the Default WLAN Measurement (Modulation Accuracy, Flatness and Tolerance)

- Example:** `INP:ATT:AUTO ON`  
Couples the attenuation to the reference level.
- Usage:** SCPI confirmed
- Manual control:** See ["RF Attenuation"](#) on page 64  
See ["Attenuation Mode / Value"](#) on page 64

#### **INPut:EATT <Attenuation>**

This command defines an electronic attenuation manually. Automatic mode must be switched off (`INP:EATT:AUTO OFF`, see `INPut:EATT:AUTO` on page 119).

If the current reference level is not compatible with an attenuation that has been set manually, the command also adjusts the reference level.

This command is only available with option R&S FSW-B25.

It is not available if R&S FSW-B17 is active.

#### **Parameters:**

<Attenuation>           attenuation in dB  
Range:            see data sheet  
Increment:        1 dB  
\*RST:            0 dB (OFF)

**Example:** `INP:EATT:AUTO OFF`  
`INP:EATT 10 dB`

**Manual control:** See ["Using Electronic Attenuation \(Option B25\)"](#) on page 64

#### **INPut:EATT:AUTO <State>**

This command turns automatic selection of the electronic attenuation on and off.

If on, electronic attenuation reduces the mechanical attenuation whenever possible.

This command is only available with option R&S FSW-B25.

It is not available if R&S FSW-B17 is active.

#### **Parameters:**

<State>                ON | OFF  
\*RST:            ON

**Example:** `INP:EATT:AUTO OFF`

**Manual control:** See ["Using Electronic Attenuation \(Option B25\)"](#) on page 64

#### **INPut:EATT:STATe <State>**

This command turns the electronic attenuator on and off.

This command is only available with option R&S FSW-B25.

It is not available if R&S FSW-B17 is active.

Configuring the Default WLAN Measurement (Modulation Accuracy, Flatness and Tolerance)

**Parameters:**

<State> ON | OFF  
\*RST: OFF

**Example:**

INP:EATT:STAT ON  
Switches the electronic attenuator into the signal path.

**Manual control:**

See ["Using Electronic Attenuation \(Option B25\)"](#) on page 64

**INPut:GAIN[:VALue] <Gain>**

This command selects the preamplification level if the preamplifier is activated (INP:GAIN:STAT ON, see [INPut:GAIN:STATe](#) on page 120).

The command requires option R&S FSW-B24.

**Parameters:**

<Gain> 15 dB | 30 dB  
The availability of preamplification levels depends on the R&S FSW model.

- R&S FSW8: 15dB and 30 dB
- R&S FSW13: 15dB and 30 dB
- R&S FSW26: 30 dB

All other values are rounded to the nearest of these two.  
\*RST: OFF

**Example:**

INP:GAIN:VAL 30  
Switches on 30 dB preamplification.

**Usage:**

SCPI confirmed

**Manual control:**

See ["Input Settings"](#) on page 65  
See ["Preamplifier \(option B24\)"](#) on page 65

**INPut:GAIN:STATe <State>**

This command turns the preamplifier on and off.

The command requires option R&S FSW-B24.

**Parameters:**

<State> ON | OFF  
\*RST: OFF

**Example:**

INP:GAIN:STAT ON  
Switches on 30 dB preamplification.

**Usage:**

SCPI confirmed

**Manual control:**

See ["Input Settings"](#) on page 65  
See ["Preamplifier \(option B24\)"](#) on page 65



Configuring the Default WLAN Measurement (Modulation Accuracy, Flatness and Tolerance)

## 9.4.4 Signal Capturing

The following commands are required to configure how much and how data is captured from the input signal.

- [General Capture Settings](#)..... 121
- [Configuring Triggered Measurements](#)..... 122

### 9.4.4.1 General Capture Settings

<a href="#">[SENSe:]BANDwidth[:RESolution]:FILTer[:STATe]</a> .....	121
<a href="#">[SENSe:]SWAPiq</a> .....	121
<a href="#">[SENSe:]SWEep:TIME</a> .....	122
<a href="#">TRACe:IQ:SRATe</a> .....	122

---

#### **[SENSe:]BANDwidth[:RESolution]:FILTer[:STATe] <State>**

This remote control command enables or disables use of the adjacent channel filter.

If activated, only the useful signal is analyzed, all signal data in adjacent channels is removed by the filter. This setting improves the signal to noise ratio and thus the EVM results for signals with strong or a large number of adjacent channels. However, for some measurements information on the effects of adjacent channels on the measured signal may be of interest.

#### **Parameters:**

<State>                    ON | OFF  
                               \*RST:        ON

**Manual control:**        See "[Suppressing \(Filter out\) Adjacent Channels](#)" on page 67

---

#### **[SENSe:]SWAPiq <State>**

This command defines whether or not the recorded IQ pairs should be swapped (I<->Q) before being processed. Swapping I and Q inverts the sideband.

This is useful if the DUT interchanged the I and Q parts of the signal; then the FSW can do the same to compensate for it.

#### **Parameters:**

<State>                    **ON**  
                               I and Q signals are interchanged  
                               Inverted sideband, Q+j\*I  
                               **OFF**  
                               I and Q signals are not interchanged  
                               Normal sideband, I+j\*Q

**Manual control:**        See "[Swap IQ](#)" on page 66

## Configuring the Default WLAN Measurement (Modulation Accuracy, Flatness and Tolerance)

---

**[SENSe:]SWEep:TIME** <Time>

This command defines the sweep (or: data capture) time.

**Parameters:**

<Time> refer to data sheet  
 \*RST: (AUTO is set to ON)

**Example:** SWE:TIME 10s

**Usage:** SCPI confirmed

**Manual control:** See "[Capture Time](#)" on page 66

---

**TRACe:IQ:SRATe** <SampleRate>

This command sets the final user sample rate for the acquired I/Q data. Thus, the user sample rate can be modified without affecting the actual data capturing settings on the R&S FSW.

**Note:** The smaller the user sample rate, the smaller the usable I/Q bandwidth, see [chapter A.1, "Sample Rate and Maximum Usable I/Q Bandwidth for RF Input"](#), on page 201.

**Parameters:**

<SampleRate> The valid sample rates are described in [chapter A.1, "Sample Rate and Maximum Usable I/Q Bandwidth for RF Input"](#), on page 201.  
 Range: 100 Hz to 10 GHz continuously adjustable;  
 \*RST: 32 MHz

**Manual control:** See "[Input Sample Rate](#)" on page 66

---

#### 9.4.4.2 Configuring Triggered Measurements

The following commands are required to configure a triggered measurement in a remote environment. The tasks for manual operation are described in [chapter 5.3.5.2, "Trigger Settings"](#), on page 67.



The \*OPC command should be used after commands that retrieve data so that subsequent commands to change the selected trigger source are held off until after the sweep is completed and the data has been returned.

---

- [Configuring the Triggering Conditions](#)..... 122
- [Configuring the Trigger Output](#)..... 128

#### Configuring the Triggering Conditions

<a href="#">TRIGger[:SEquence]:DTIME</a> .....	123
<a href="#">TRIGger[:SEquence]:HOLDoff[:TIME]</a> .....	123
<a href="#">TRIGger[:SEquence]:IFPower:HOLDoff</a> .....	123
<a href="#">TRIGger[:SEquence]:IFPower:HYSTeresis</a> .....	124
<a href="#">TRIGger[:SEquence]:LEVel:BBPower</a> .....	124

## Configuring the Default WLAN Measurement (Modulation Accuracy, Flatness and Tolerance)

TRIGger[:SEquence]:LEVel[:EXTeRnal<port>].....	124
TRIGger[:SEquence]:LEVel:IFPower.....	125
TRIGger[:SEquence]:LEVel:IQPower.....	125
TRIGger[:SEquence]:LEVel:RFPower.....	125
TRIGger[:SEquence]:SLOPe.....	126
TRIGger[:SEquence]:SOURce.....	126
TRIGger[:SEquence]:TIME:RINTerval.....	127

**TRIGger[:SEquence]:DTIME** <DropoutTime>

Defines the time the input signal must stay below the trigger level before a trigger is detected again.

**Parameters:**

<DropoutTime> Dropout time of the trigger.  
 Range: 0 s to 10.0 s  
 \*RST: 0 s

**Manual control:** See ["Trigger Source Settings"](#) on page 68  
 See ["Drop-Out Time"](#) on page 71

**TRIGger[:SEquence]:HOLDoff[:TIME]** <Offset>

Defines the time offset between the trigger event and the start of the sweep (data capturing).

**Parameters:**

<Offset> \*RST: 0 s

**Example:** TRIG:HOLD 500us

**Manual control:** See ["Trigger Source Settings"](#) on page 68  
 See ["Trigger Offset"](#) on page 71

**TRIGger[:SEquence]:IFPower:HOLDoff** <Period>

This command defines the holding time before the next trigger event.

Note that this command is available for **any trigger source**, not just IF Power.

**Parameters:**

<Period> \*RST: 150 ns

**Example:** TRIG:SOUR IFP  
 Sets the IF power trigger source.  
 TRIG:IFP:HOLD 200 ns  
 Sets the holding time to 200 ns.

**Manual control:** See ["Trigger Source Settings"](#) on page 68  
 See ["Trigger Holdoff"](#) on page 72

**TRIGger[:SEQuence]:IFPower:HYSTeresis <Hysteresis>**

This command defines the trigger hysteresis.

**Parameters:**

<Hysteresis>            Range:     3 dB to 50 dB  
                             \*RST:     3 dB

**Example:**

```
TRIG:SOUR IFP
Sets the IF power trigger source.
TRIG:IFP:HYST 10DB
Sets the hysteresis limit value.
```

**Manual control:**    See "[Trigger Source Settings](#)" on page 68  
                             See "[Hysteresis](#)" on page 71

**TRIGger[:SEQuence]:LEVel:BBPower <Level>**

This command sets the level of the baseband power trigger.

This command is available with the **Digital Baseband Interface (R&S FSW-B17)**.

**Parameters:**

<Level>                 Range:     -50 dBm to +20 dBm  
                             \*RST:     -20 DBM

**Example:**

```
TRIG:LEV:BB -30DBM
```

**TRIGger[:SEQuence]:LEVel[:EXTernal<port>] <TriggerLevel>**

This command defines the level the external signal must exceed to cause a trigger event.

Note that the variable INPUT/OUTPUT connectors (ports 2+3) must be set for use as input using the `OUTPut:TRIGger<port>:DIRection` command.

For details on the trigger source see "[Trigger Source Settings](#)" on page 68.

**Suffix:**

<port>                 1 | 2 | 3  
                             Selects the trigger port.  
                             1 = trigger port 1 (TRIGGER INPUT connector on front panel)  
                             2 = trigger port 2 (TRIGGER INPUT/OUTPUT connector on front panel)  
                             3 = trigger port 3 (TRIGGER3 INPUT/OUTPUT connector on rear panel)

**Parameters:**

<TriggerLevel>        Range:     0.5 V to 3.5 V  
                             \*RST:     1.4 V

**Example:**

```
TRIG:LEV 2V
```

**Manual control:**    See "[Trigger Source Settings](#)" on page 68  
                             See "[Trigger Level](#)" on page 71

**TRIGger[:SEQuence]:LEVel:IFPower** <TriggerLevel>

This command defines the power level at the third intermediate frequency that must be exceeded to cause a trigger event. Note that any RF attenuation or preamplification is considered when the trigger level is analyzed.

For details on the trigger source see "[Trigger Source Settings](#)" on page 68.

**Parameters:**

<TriggerLevel>      Range:      -50 dBm to 20 dBm  
                          \*RST:      -20 dBm

**Example:**

TRIG:LEV:IFP -30DBM

**Manual control:**

See "[Trigger Source Settings](#)" on page 68  
 See "[Trigger Level](#)" on page 71

**TRIGger[:SEQuence]:LEVel:IQPower** <TriggerLevel>

This command defines the magnitude the I/Q data must exceed to cause a trigger event. Note that any RF attenuation or preamplification is considered when the trigger level is analyzed.

For details on the trigger source see "[Trigger Source Settings](#)" on page 68.

**Parameters:**

<TriggerLevel>      Range:      -130 dBm to 30 dBm  
                          \*RST:      -20 dBm

**Example:**

TRIG:LEV:IQP -30DBM

**Manual control:**

See "[Trigger Source Settings](#)" on page 68  
 See "[Trigger Level](#)" on page 71

**TRIGger[:SEQuence]:LEVel:RFPower** <TriggerLevel>

This command defines the power level the RF input must exceed to cause a trigger event. Note that any RF attenuation or preamplification is considered when the trigger level is analyzed.

The input signal must be between 500 MHz and 8 GHz.

For details on the trigger source see "[Trigger Source Settings](#)" on page 68.

**Parameters:**

<TriggerLevel>      Range:      -50 dBm to -10 dBm  
                          \*RST:      -20 dBm

**Example:**

TRIG:LEV:RFP -30dBm

**Manual control:**

See "[Trigger Source Settings](#)" on page 68  
 See "[Trigger Level](#)" on page 71

---

**TRIGger[:SEQuence]:SLOPe** <Type>

For all trigger sources except time you can define whether triggering occurs when the signal rises to the trigger level or falls down to it.

**Parameters:**

<Type>                      POSitive | NEGative

**POSitive**

Triggers when the signal rises to the trigger level (rising edge).

**NEGative**

Triggers when the signal drops to the trigger level (falling edge).

\*RST:            POSitive

**Example:**                      TRIG:SLOP NEG

**Manual control:**            See "[Trigger Source Settings](#)" on page 68  
See "[Slope](#)" on page 72

---

**TRIGger[:SEQuence]:SOURce** <Source>

This command selects the trigger source.

For details on the available trigger sources see "[Trigger Source Settings](#)" on page 68.

**Note on external triggers:**

If a measurement is configured to wait for an external trigger signal in a remote control program, remote control is blocked until the trigger is received and the program can continue. Make sure this situation is avoided in your remote control programs.

## Configuring the Default WLAN Measurement (Modulation Accuracy, Flatness and Tolerance)

**Parameters:**

&lt;Source&gt;

**IMMediate**

Free Run

**EXTErn**

Trigger signal from the TRIGGER INPUT connector.

**EXT2**

Trigger signal from the TRIGGER INPUT/OUTPUT connector.

Note: Connector must be configured for "Input".

**EXT3**

Trigger signal from the TRIGGER 3 INPUT/ OUTPUT connector.

Note: Connector must be configured for "Input".

**RFPower**

First intermediate frequency

**IFPower**

Second intermediate frequency

**IQPower**

Magnitude of sampled I/Q data

For applications that process I/Q data, such as the I/Q Analyzer or optional applications

**TIME**

Time interval

**PSEN**

External power sensor

\*RST: IMMediate

**Example:**

TRIG:SOUR EXT

Selects the external trigger input as source of the trigger signal

**Manual control:**See ["Trigger Source Settings"](#) on page 68See ["Trigger Source"](#) on page 69See ["Free Run"](#) on page 69See ["External Trigger 1/2/3"](#) on page 69See ["IF Power"](#) on page 69See ["IQ Power"](#) on page 70See ["RF Power"](#) on page 70See ["Power Sensor"](#) on page 70See ["Time"](#) on page 70**TRIGger[:SEQuence]:TIME:RINTerval <Interval>**

This command defines the repetition interval for the time trigger.

**Parameters:**

&lt;Interval&gt;

2.0 ms to 5000

Range: 2 ms to 5000 s

\*RST: 1.0 s

## Configuring the Default WLAN Measurement (Modulation Accuracy, Flatness and Tolerance)

- Example:**           TRIG:SOUR TIME  
Selects the time trigger input for triggering.  
TRIG:TIME:RINT 50  
The sweep starts every 50 s.
- Manual control:**   See "Trigger Source Settings" on page 68  
See "Repetition Interval" on page 71

**Configuring the Trigger Output**

The following commands are required to send the trigger signal to one of the variable TRIGGER INPUT/OUTPUT connectors. The tasks for manual operation are described in "Trigger 2/3" on page 60.

OUTPut:TRIGger<port>:DIRection.....	128
OUTPut:TRIGger<port>:LEVel.....	128
OUTPut:TRIGger<port>:OTYPe.....	129
OUTPut:TRIGger<port>:PULSe:IMMEDIATE.....	129
OUTPut:TRIGger<port>:PULSe:LENGth.....	130

**OUTPut:TRIGger<port>:DIRection <Direction>**

This command selects the trigger direction.

- Suffix:**  
<port>                   2 | 3  
Selects the trigger port to which the output is sent.  
2 = trigger port 2 (front)  
3 = trigger port 3 (rear)

- Parameters:**  
<Direction>           **INPut**  
Port works as an input.  
**OUTPut**  
Port works as an output.  
\*RST:           INPut

- Manual control:**   See "Trigger 2/3" on page 60

**OUTPut:TRIGger<port>:LEVel <Level>**

This command defines the level of the signal generated at the trigger output.

This command works only if you have selected a user defined output with `OUTPut:TRIGger<port>:OTYPe`.

- Suffix:**  
<port>                   2 | 3  
Selects the trigger port to which the output is sent.  
2 = trigger port 2 (front)  
3 = trigger port 3 (rear)



## Configuring the Default WLAN Measurement (Modulation Accuracy, Flatness and Tolerance)

**Parameters:**

<Level>                   **HIGH**  
 TTL signal.

**LOW**  
 0 V

\*RST:            LOW

**Manual control:**

See ["Trigger 2/3"](#) on page 60  
 See ["Output Type"](#) on page 60  
 See ["Level"](#) on page 60

**OUTPut:TRIGger<port>:OTYPe <OutputType>**

This command selects the type of signal generated at the trigger output.

**Suffix:**

<port>                    2 | 3  
 Selects the trigger port to which the output is sent.  
 2 = trigger port 2 (front)  
 3 = trigger port 3 (rear)

**Parameters:**

<OutputType>           **DEvice**  
 Sends a trigger signal when the R&S FSW has triggered internally.

**TARMed**  
 Sends a trigger signal when the trigger is armed and ready for an external trigger event.

**UDEFineD**  
 Sends a user defined trigger signal. For more information see [OUTPut:TRIGger<port>:LEVel](#).

\*RST:            DEvice

**Manual control:**

See ["Trigger 2/3"](#) on page 60  
 See ["Output Type"](#) on page 60

**OUTPut:TRIGger<port>:PULSe:IMMediate**

This command generates a pulse at the trigger output.

**Suffix:**

<port>                    2 | 3  
 Selects the trigger port to which the output is sent.  
 2 = trigger port 2 (front)  
 3 = trigger port 3 (rear)

**Usage:**

Event

**Manual control:**

See ["Trigger 2/3"](#) on page 60  
 See ["Output Type"](#) on page 60  
 See ["Send Trigger"](#) on page 61

**OUTPut:TRIGger<port>:PULSe:LENGth <Length>**

This command defines the length of the pulse generated at the trigger output.

**Suffix:**

<port>                    2 | 3  
 Selects the trigger port to which the output is sent.  
 2 = trigger port 2 (front)  
 3 = trigger port 3 (rear)

**Parameters:**

<Length>                Pulse length in seconds.

**Manual control:**    See "Trigger 2/3" on page 60  
                               See "Output Type" on page 60  
                               See "Pulse Length" on page 61

### 9.4.5 Synchronization and OFDM Demodulation

[SENSe:]DEMod:FFT:OFFSet.....	130
[SENSe:]DEMod:TXARea.....	130

**[SENSe:]DEMod:FFT:OFFSet <Mode>**

This command specifies the start offset of the FFT for OFDM demodulation (not for the FFT Spectrum display).

**Parameters:**

<Mode>                    AUTO | GICenter | PEAK

**AUTO**  
 The FFT start offset is automatically chosen to minimize the inter-symbol interference.

**GICenter**  
 Guard Interval Center: The FFT start offset is placed to the center of the guard interval.

**PEAK**  
 The peak of the fine timing metric is used to determine the FFT start offset.

\*RST:                    AUTO

**Manual control:**    See "FFT Start Offset" on page 74

**[SENSe:]DEMod:TXARea <State>**

If enabled, the R&S FSW WLAN application initially performs a coarse burst search on the input signal in which increases in the power vs time trace are detected. Further time-consuming processing is then only performed where bursts are assumed. This improves the measurement speed for signals with low duty cycle rates.

## Configuring the Default WLAN Measurement (Modulation Accuracy, Flatness and Tolerance)

However, for signals in which the PPDU power levels differ significantly, this option should be disabled as otherwise some PPDU's may not be detected.

**Parameters:**

<State> ON | OFF

**ON**  
A coarse burst search is performed based on the power levels of the input signal.

**OFF**  
No pre-evaluation is performed, the entire signal is processed.

\*RST: ON

**Manual control:** See "[Power Interval Search](#)" on page 73

### 9.4.6 Tracking and Channel Estimation

<a href="#">[SENSe:]DEMod:CESTimation</a> .....	131
<a href="#">[SENSe:]TRACking:LEVel</a> .....	131
<a href="#">[SENSe:]TRACking:PHASe</a> .....	132
<a href="#">[SENSe:]TRACking:PILots</a> .....	132
<a href="#">[SENSe:]TRACking:TIME</a> .....	132

---

#### **[SENSe:]DEMod:CESTimation** <State>

This command defines whether channel estimation will be done in preamble and payload or only in preamble. The effect of this is most noticeable for the EVM measurement results, where the results will be improved when this feature is enabled.

However, this functionality is not supported by the IEEE 802.11 standard and must be disabled if the results are to be measured strictly according to the standard.

**Parameters:**

<State> ON | OFF

**ON**  
The channel estimation is performed in the preamble and the payload. The EVM results can be calculated more accurately.

**OFF**  
The channel estimation is performed in the preamble as required in the standard.

\*RST: OFF

**Manual control:** See "[Channel Estimation Range](#)" on page 75

---

#### **[SENSe:]TRACking:LEVel** <State>

Activates or deactivates the compensation for level variations within a single PPDU. If activated, the measurement results are compensated for level error on a per-symbol basis.

## Configuring the Default WLAN Measurement (Modulation Accuracy, Flatness and Tolerance)

**Parameters:**

<State> ON | OFF  
 \*RST: OFF

**Manual control:** See "[Level Error \(Gain\) Tracking](#)" on page 75

**[SENSe:]TRACking:PHASe <State>**

Activates or deactivates the compensation for phase drifts. If activated, the measurement results are compensated for phase drifts on a per-symbol basis.

**Parameters:**

<State> ON | OFF  
 \*RST: ON

**Manual control:** See "[Phase Tracking](#)" on page 75

**[SENSe:]TRACking:PILOts <Mode>**

In case tracking is used, the used pilot sequence has an effect on the measurement results.

**Parameters:**

<Mode> STANdard | DETected

**STANdard**

The pilot sequence is determined according to the corresponding WLAN standard. In case the pilot generation algorithm of the device under test (DUT) has a problem, the non-standard-conform pilot sequence might affect the measurement results, or the WLAN application might not synchronize at all onto the signal generated by the DUT.

**DETEcted**

The pilot sequence detected in the WLAN signal to be analyzed is used by the WLAN application. In case the pilot generation algorithm of the device under test (DUT) has a problem, the non-standard-conform pilot sequence will not affect the measurement results. In case the pilot sequence generated by the DUT is correct, it is recommended that you use the "According to Standard" setting because it generates more accurate measurement results.

\*RST: STANdard

**Manual control:** See "[Pilots for Tracking](#)" on page 75

**[SENSe:]TRACking:TIME <State>**

Activates or deactivates the compensation for timing drift. If activated, the measurement results are compensated for timing error on a per-symbol basis.

Configuring the Default WLAN Measurement (Modulation Accuracy, Flatness and Tolerance)

**Parameters:**

<State> ON | OFF  
 \*RST: OFF

**Manual control:** See "[Timing Error Tracking](#)" on page 75

### 9.4.7 Demodulation

The demodulation settings define which PPDU's are to be analyzed, thus they define a *logical filter*.

The available demodulation settings vary depending on the selected digital standard (see [CONFigure:STANdard](#) on page 112).

Manual configuration is described in [chapter 5.3.8, "Demodulation"](#), on page 76.

<a href="#">CONFigure:WLAN:EXTension:AUTO:TYPE</a> .....	133
<a href="#">CONFigure:WLAN:GTIme:AUTO</a> .....	134
<a href="#">CONFigure:WLAN:GTIme:AUTO:TYPE</a> .....	134
<a href="#">CONFigure:WLAN:GTIme:SElect</a> .....	135
<a href="#">CONFigure:WLAN:STBC:AUTO:TYPE</a> .....	136
<a href="#">[SENSe:]BANDwidth:CHANnel:AUTO:TYPE</a> .....	136
<a href="#">[SENSe:]DEMod:FORMat:BANalyze</a> .....	138
<a href="#">[SENSe:]DEMod:FORMat:BANalyze:BTYPe:AUTO:TYPE</a> .....	138
<a href="#">[SENSe:]DEMod:FORMat[:BContent]:AUTO</a> .....	139
<a href="#">[SENSe:]DEMod:FORMat:MCsindex</a> .....	140
<a href="#">[SENSe:]DEMod:FORMat:MCsindex:MODE</a> .....	140
<a href="#">[SENSe:]DEMod:FORMat:NSTsindex</a> .....	141
<a href="#">[SENSe:]DEMod:FORMat:NSTsindex:MODE</a> .....	141

---

#### **CONFigure:WLAN:EXTension:AUTO:TYPE** <PPDUType>

Defines the PPDU's taking part in the analysis according to the Ness (Extension Spatial Streams) field content (for **IEEE 802.11n** standard only).

## Configuring the Default WLAN Measurement (Modulation Accuracy, Flatness and Tolerance)

**Parameters:**

&lt;PPDUType&gt;

FBURst | ALL | M0 | M1 | M2 | M3 | D0 | D1 | D2 | D3

The first PPDU is analyzed and subsequent PDUs are analyzed only if they match

**FBURst**

The Ness field contents of the first PPDU is detected and subsequent PDUs are analyzed only if they have the same Ness field contents (corresponds to "Auto, same type as first PPDU")

**ALL**

All recognized PDUs are analyzed according to their individual Ness field contents (corresponds to "Auto, individually for each PPDU")

**M0 | M1 | M2 | M3**

Only PDUs with the specified Ness value are analyzed.

**D0 | D1 | D2 | D3**

All PDUs are analyzed assuming the specified Ness value.

\*RST: FBURst

**Example:**

```
CONF:WLAN:EXT:AUTO:TYPE M0
```

**Manual control:**

See "[Extension Spatial Streams \(sounding\) \(IEEE 802.11 N\)](#)" on page 81

**CONFigure:WLAN:GTIMe:AUTO <State>**

This remote control command specifies whether the guard time of the input signal is automatically detected or specified manually (**IEEE 802.11n or ac** only).

**Parameters:**

&lt;State&gt;

**ON**

The guard time is detected automatically according to [CONFigure:WLAN:GTIMe:AUTO:TYPE](#) on page 134.

**OFF**

The guard time is defined by the [CONFigure:WLAN:GTIMe:SElect](#) command.

\*RST: ON

**Manual control:**

See "[Guard Interval Length \(IEEE 802.11 N, AC\)](#)" on page 81

**CONFigure:WLAN:GTIMe:AUTO:TYPE <Type>**

This remote control command specifies which PDUs are analyzed depending on their guard length if automatic detection is used (`CONF:WLAN:GTIM:AUTO ON`, see [CONFigure:WLAN:GTIMe:AUTO](#) on page 134).

This command is available for **IEEE 802.11 n, ac** standards only.

## Configuring the Default WLAN Measurement (Modulation Accuracy, Flatness and Tolerance)

**Note:** On previous R&S Signal and Spectrum analyzers, this command configured both the guard interval type and the channel bandwidth. On the R&S FSW, this command only configures the guard type. The channel bandwidth of the PPDU to be measured must be configured separately using the `[SENSe:]BANDwidth:CHANnel:AUTO:TYPE` command.

**Parameters:**

&lt;Type&gt;

**FBURst**

The Guard interval length of the first PPDU is detected and subsequent PDUs are analyzed only if they have the same length (corresponds to "Auto, same type as first PPDU")

**ALL**

All PDUs are analyzed regardless of their guard length (corresponds to "Auto, individually for each PPDU").

**MS**

Only PDUs with short guard interval length are analyzed. (corresponds to "Meas only Short" in manual operation; MN8 | MN16 parameters in previous R&S Signal and Spectrum Analyzers)

**ML**

Only PDUs with long guard interval length are analyzed. (corresponds to "Meas only Long" in manual operation; ML16 | ML32 parameters in previous R&S Signal and Spectrum Analyzers)

**DS**

All PDUs are demodulated assuming short guard interval length. (corresponds to "Demod all as short" in manual operation; DN8 | DN16 parameters in previous R&S Signal and Spectrum Analyzers)

**DL**

All PDUs are demodulated assuming long guard interval length. (corresponds to "Demod all as long" in manual operation; DL16 | DL32 parameters in previous R&S Signal and Spectrum Analyzers)

```
*RST: 'ALL'
```

**Example:**

```
CONF:WLAN:GTIM:AUTO:TYPE DL
```

**Manual control:**

See "[Guard Interval Length \(IEEE 802.11 N, AC\)](#)" on page 81

**CONFigure:WLAN:GTIMe:SElect** <GuardTime>

This remote control command specifies the guard time the PDUs in the **IEEE 802.11n** or **ac** input signal should have. If the guard time is specified to be detected from the input signal using the `CONFigure:WLAN:GTIMe:AUTO` command then this command is query only and allows the detected guard time to be obtained.

## Configuring the Default WLAN Measurement (Modulation Accuracy, Flatness and Tolerance)

**Parameters:**

&lt;GuardTime&gt; SHORT | NORMAl

**SHORT**

Only the PPDUs with short guard interval are analyzed.

**NORMAl**Only the PPDUs with long guard interval are analyzed.  
("Long" in manual operation)

\*RST: NORMAl

**Example:**

CONF:WLAN:GTIM:SEL SHOR

**Manual control:**See "[Guard Interval Length \(IEEE 802.11 N, AC\)](#)" on page 81**CONFigure:WLAN:STBC:AUTO:TYPE** <PPDUType>This remote control command specifies which PPDUs are analyzed according to STBC streams (for **IEEE 802.11n, ac** standards only).**Parameters:**

&lt;PPDUType&gt; FBURst | ALL | M0 | M1 | M2 | D0 | D1 | D2

**FBURst**

The STBC of the first PPDU is detected and subsequent PPDUs are analyzed only if they have the same STBC (corresponds to "Auto, same type as first PPDU")

**ALL**

All recognized PPDUs are analyzed according to their individual STBC (corresponds to "Auto, individually for each PPDU")

**M0 | M1 | M2**

Measure only if STBC field = 0 | 1 | 2

For details see "[STBC Field \(IEEE 802.11 AC,N\)](#)" on page 80**D0 | D1 | D2**

Demod all as STBC field = 0 | 1 | 2

For details see "[STBC Field \(IEEE 802.11 AC,N\)](#)" on page 80**Example:**

CONF:WLAN:STBC:AUTO:TYPE M0

**Manual control:**See "[STBC Field \(IEEE 802.11 AC,N\)](#)" on page 80**[SENSe:]BANDwidth:CHANnel:AUTO:TYPE** <Bandwidth>

This remote control command specifies the bandwidth in which the PPDUs are analyzed.

Note that channel bandwidths larger than 10 MHz require a R&S FSW bandwidth extension option, see [chapter A.1, "Sample Rate and Maximum Usable I/Q Bandwidth for RF Input"](#), on page 201.



## Configuring the Default WLAN Measurement (Modulation Accuracy, Flatness and Tolerance)

**Parameters:**

&lt;Bandwidth&gt;

FBURst | ALL | MB5 | MB10 | MB20 | MB40 | MB80 | DB20 | DB40 | DB80

**FBURSt**

The channel bandwidth of the first valid PPDU is detected and subsequent PDUs are analyzed only if they have the same channel bandwidth (corresponds to "Auto, same type as first PDU")

**ALL**

All PDUs are analyzed regardless of the channel bandwidth (corresponds to "Auto, individually for each PDU")

**MB5**

Only PDUs within a channel bandwidth of 5MHz are analyzed (IEEE 802.11 a only)

**MB10**

Only PDUs within a channel bandwidth of 10MHz are analyzed (IEEE 802.11 a only)

**MB20**

Only PDUs within a channel bandwidth of 20MHz are analyzed

**MB40**

Only PDUs within a channel bandwidth of 40MHz are analyzed (IEEE 802.11 n, ac only)

**MB80**

Only PDUs within a channel bandwidth of 80MHz are analyzed (IEEE 802.11 ac only)

**MB160**

Only PDUs within a channel bandwidth of 160MHz are analyzed (IEEE 802.11 ac only)

**DB5**

All PDUs are analyzed within a channel bandwidth of 5MHz (IEEE 802.11 a only)

**DB10**

All PDUs are analyzed within a channel bandwidth of 10MHz (IEEE 802.11 a only)

**DB20**

All PDUs are analyzed within a channel bandwidth of 20MHz

**DB40**

All PDUs are analyzed within a channel bandwidth of 40MHz (IEEE 802.11 n, ac only)

**DB80**

All PDUs are analyzed within a channel bandwidth of 80MHz (IEEE 802.11 n, ac only)

**DB160**

All PDUs are analyzed within a channel bandwidth of 160MHz (IEEE 802.11 n, ac only)

\*RST: FBURst

**Example:**

SENS: BAND: CHAN: AUTO: TYPE MB20

Configuring the Default WLAN Measurement (Modulation Accuracy, Flatness and Tolerance)

**Manual control:** See ["Channel Bandwidth to measure \(CBW\)"](#) on page 78

---

**[SENSe:]DEMod:FORMat:BANalyze <Format>**

Specifies which PSDUs are to be analyzed depending on their modulation. Only PSDUs using the selected modulation are considered in result analysis.

This command is only available for the **IEEE 802.11 a** standard.

Note: to analyze all PPDU that are identical to the first detected PPDU (corresponds to "Auto, same type as first PPDU"), use the command:

```
SENS:DEMO:FORM:BANA:BTYP:AUTO:TYPE FBUR.
```

To analyze all PPDU regardless of their format and modulation (corresponds to "Auto, individually for each PPDU") , use the command:

```
SENS:DEMO:FORM:BANA:BTYP:AUTO:TYPE ALL.
```

See [\[SENSe:\]DEMod:FORMat:BANalyze:BTYPe:AUTO:TYPE](#) on page 138.

**Parameters:**

<Format>                    \*RST:        QAM64

**Example:**                    SENS:DEMO:FORM:BAN 'BPSK6'

**Manual control:**        See ["PPDU Format to measure"](#) on page 77  
                               See ["PSDU Modulation to use \(IEEE 802.11 A\)"](#) on page 78  
                               See ["PSDU Modulation \(IEEE 802.11 A\)"](#) on page 79

**Table 9-4: Modulation format parameters for IEEE 802.11 a standard**

SCPI parameter	Dialog parameter
BPSK6	BPSK 1/2
BPSK9	BPSK 3/4
QPSK12	QPSK 1/2
QPSK18	QPSK 3/4
QAM1624	16-QAM 1/2
QAM1636	16-QAM 3/4
QAM6448	64-QAM 2/3
QAM6454	64-QAM 3/4

---

**[SENSe:]DEMod:FORMat:BANalyze:BTYPe:AUTO:TYPE <Analysis>**

This remote control command specifies how signals are analyzed.

## Configuring the Default WLAN Measurement (Modulation Accuracy, Flatness and Tolerance)

**Parameters:**

&lt;Analysis&gt;

FBURst | ALL | MMIX | MGRF | DMIX | DGRF | MVHT | DVHT | MNHT | DNHT

**FBURSt**

The format of the first valid PPDU is detected and subsequent PDUs are analyzed only if they have the same format (corresponds to "Auto, same type as first PDU")

**ALL**

All PDUs are analyzed regardless of their format (corresponds to "Auto, individually for each PDU")

**MNHT**

Only PDUs with format "Non-HT" are analyzed

**(IEEE 802.11 a)****DNHT**

All PDUs are assumed to have the PDU format "Non-HT"

**(IEEE 802.11 a)****MMIX**

Only PDUs with format "HT-MF" (Mixed) are analyzed

**(IEEE 802.11 n)****MGRF**

Only PDUs with format "HT-GF" (Greenfield) are analyzed

**(IEEE 802.11 n)****DMIX**

All PDUs are assumed to have the PDU format "HT-MF"

**(IEEE 802.11 n)****DGRF**

All PDUs are assumed to have the PDU format "HT-GF"

**(IEEE 802.11 n)****MVHT**

Only PDUs with format "VHT" are analyzed

**(IEEE 802.11 ac)****DVHT**

All PDUs are assumed to have the PDU format "VHT"

**(IEEE 802.11 ac)**

\*RST: FBURSt

**Example:**

SENS:DEM:FORM:BAN:BTYP:AUTO:TYPE FBUR

**Manual control:**See ["PDU Format to measure"](#) on page 77See ["PSDU Modulation to use \(IEEE 802.11 A\)"](#) on page 78**[SENSe:]DEMod:FORMat[:BContent]:AUTO <State>**

This command determines whether the PDUs to be analyzed are determined automatically or by the user.

## Configuring the Default WLAN Measurement (Modulation Accuracy, Flatness and Tolerance)

**Parameters:**

&lt;State&gt;

**ON**

The signal field, i.e. the PLCP header field, of the first recognized PPDU is analyzed to determine the details of the PPDU. All PPDU identical to the first recognized PPDU are analyzed.

**OFF**

Only PPDU that match the user-defined PPDU type and modulation are considered in results analysis (see [\[SENSe:\]DEMod:FORMat:BANalyze:BTYPe:AUTO:TYPE](#) on page 138 and [\[SENSe:\]DEMod:FORMat:BANalyze](#) on page 138).

**Manual control:**

See "PPDU Analysis Mode" on page 77

**[SENSe:]DEMod:FORMat:MCSindex <Index>**

This command specifies the MCS index which controls the data rate, modulation and streams (for **IEEE 802.11n**, **ac** standards only, see document: IEEE 802.11n/D11.0 June 2009).

This command is required if [\[SENSe:\]DEMod:FORMat:MCSindex:MODE](#) is set to MEAS or DEM.

**Parameters:**

&lt;Index&gt;

\*RST: 1

**Example:**

```
SENS:DEM:FORM:MCS:MODE MEAS
SENS:DEM:FORM:MCS 1
```

**Manual control:**

See "MCS Index (IEEE 802.11 N, AC)" on page 79

**[SENSe:]DEMod:FORMat:MCSindex:MODE <Mode>**

This command defines the PPDU taking part in the analysis depending on their Modulation and Coding Scheme (MCS) index (for **IEEE 802.11n**, **ac** standards only).

## Configuring the Default WLAN Measurement (Modulation Accuracy, Flatness and Tolerance)

**Parameters:**

&lt;Mode&gt;

FBURst | ALL | MEASure | DEMod

**FBURst**

The MCS index of the first PPDU is detected and subsequent PDUs are analyzed only if they have the same MCS index (corresponds to "Auto, same type as first PDU")

**ALL**

All recognized PDUs are analyzed according to their individual MCS indexes (corresponds to "Auto, individually for each PDU")

**MEASure**

Only PDUs with an MCS index which matches that specified by `[SENSe:]DEMod:FORMat:MCSindex` are analyzed

**DEMod**

All PDUs will be analyzed according to the MCS index specified by `[SENSe:]DEMod:FORMat:MCSindex`.

\*RST: FBURst

**Example:**

```
SENS:DEM:FORM:MCS:MODE MEAS
SENS:DEM:FORM:MCS 1
```

**Manual control:**See "[MCS Index to use \(IEEE 802.11 N, AC\)](#)" on page 79**[SENSe:]DEMod:FORMat:NSTSIindex <Index>**

Defines the the PDUs taking part in the analysis depending on their Nsts.

This command is only available for the **IEEE 802.11 ac** standard.

This command is available for `DEM:FORM:NSTS:MODE MEAS` or `DEM:FORM:NSTS:MODE DEM` (see [\[SENSe:\]DEMod:FORMat:NSTSIindex:MODE](#) on page 141).

**Parameters:**

&lt;Index&gt;

**Example:**

```
SENS:DEM:FORM:NSTS:MODE MEAS
SENS:DEM:FORM:NSTS 1
```

**Manual control:**See "[Nsts \(IEEE 802.11 AC\)](#)" on page 80**[SENSe:]DEMod:FORMat:NSTSIindex:MODE <Mode>**

Defines the the PDUs taking part in the analysis depending on their Nsts.

This command is only available for the **IEEE 802.11 ac** standard.

Configuring the Default WLAN Measurement (Modulation Accuracy, Flatness and Tolerance)

**Parameters:**

&lt;Mode&gt;

FBURst | ALL | MEASure | DEMod

**FBURst**

The Nsts of the first PPDU is detected and subsequent PDUs are analyzed only if they have the same Nsts (corresponds to "Auto, same type as first PPDU")

**ALL**

All recognized PDUs are analyzed according to their individual Nsts (corresponds to "Auto, individually for each PPDU")

**MEASure**

Only PDUs with the Nsts specified by [SENSe:]DEMod:FORMat:NSTSIindex are analyzed

**DEMod**

The "Nsts" index specified by [SENSe:]DEMod:FORMat:NSTSIindex is used for all PDUs.

\*RST: FBURst

**Example:**

SENS:DEM:FORM:NSTS:MODE MEAS

SENS:DEM:FORM:NSTS 1

**Manual control:**

See "Nsts to use (IEEE 802.11 AC)" on page 79

## 9.4.8 Evaluation Range

The evaluation range defines which data is evaluated in the result display.

Note that, as opposed to manual operation, the PDUs to be analyzed can be defined either by the number of data symbols, the number of data bytes, or the measurement duration.

CONFigure:WLAN:PAYLoad:LENGth:SRC.....	142
[SENSe:]BURSt:COUnT.....	143
[SENSe:]BURSt:COUnT:STATe.....	143
[SENSe:]DEMod:FORMat:BANalyze:SYMBols:EQUal.....	144
[SENSe:]DEMod:FORMat:BANalyze:SYMBols:MAX.....	144
[SENSe:]DEMod:FORMat:BANalyze:SYMBols:MIN.....	144

---

**CONFigure:WLAN:PAYLoad:LENGth:SRC <Source>**

Defines which payload length is used to determine the minimum or maximum number of required data symbols (**IEEE 802.11n, ac**).

## Configuring the Default WLAN Measurement (Modulation Accuracy, Flatness and Tolerance)

**Parameters:**

<Source>	ESTimate   HTSignal
	<b>ESTimate</b> Uses a length estimated from the input signal
	<b>HTSignal</b> (IEEE811.02 n) Determines the length of the HT signal (from the signal field)
	<b>LSignal</b> (IEEE811.02 ac) Determines the length of the L signal (from the signal field)
<b>Manual control:</b>	See " <a href="#">Source of Payload Length (IEEE811.02 AC, N)</a> " on page 83

**[SENSe:]BURSt:COUNT <Value>**

If the statistic count is enabled (see [[SENSe:\]BURSt:COUNT:STATe](#) on page 143), the specified number of PPDU is taken into consideration for the statistical evaluation (maximally the number of PPDU detected in the current capture buffer).

If disabled, all detected PPDU in the current capture buffer are considered.

**Parameters:**

<Value> \*RST: 1

**Example:** SENS:BURS:COUN:STAT ON  
SENS:BURS:COUN 10

**Manual control:** See "[PPDU Statistic Count / No of PPDU to Analyze](#)"  
on page 83

**[SENSe:]BURSt:COUNT:STATe <State>**

If the statistic count is enabled, the specified number of PPDU is taken into consideration for the statistical evaluation (maximally the number of PPDU detected in the current capture buffer).

If disabled, all detected PPDU in the current capture buffer are considered.

**Parameters:**

<State> ON | OFF  
\*RST: OFF

**Example:** SENS:BURS:COUN:STAT ON  
SENS:BURS:COUN 10

**Manual control:** See "[PPDU Statistic Count / No of PPDU to Analyze](#)"  
on page 83

**[SENSe:]DEMod:FORMat:BANalyze:SYMBOLs:EQUal <State>**

If **enabled**, only PPDU's with a **specific** payload length are considered for measurement analysis.

If **disabled**, only PPDU's whose length is within a specified **range** are considered.

The payload length is specified by the `[SENSe:]DEMod:FORMat:BANalyze:SYMBOLs:MIN` command.

A payload length **range** is defined as a minimum and maximum number of symbols the payload may contain (see `[SENSe:]DEMod:FORMat:BANalyze:SYMBOLs:MAX` on page 144 and `[SENSe:]DEMod:FORMat:BANalyze:SYMBOLs:MIN` on page 144).

**Parameters:**

<State> ON | OFF  
\*RST: OFF

**Manual control:** See "Equal PDU Length" on page 83

**[SENSe:]DEMod:FORMat:BANalyze:SYMBOLs:MAX <NumDataSymbols>**

If the `[SENSe:]DEMod:FORMat:BANalyze:SYMBOLs:EQUal` command is set to **false**, this command specifies the maximum number of symbols allowed for a PDU to take part in measurement analysis.

The number of data symbols is defined as the uncoded bits including service and tail bits.

If the `[SENSe:]DEMod:FORMat:BANalyze:SYMBOLs:EQUal` command has been set to **true**, then this command has no effect.

**Parameters:**

<NumDataSymbols> \*RST: 64

**Manual control:** See "No. of Data Symbols" on page 83

**[SENSe:]DEMod:FORMat:BANalyze:SYMBOLs:MIN <NumDataSymbols>**

If the `[SENSe:]DEMod:FORMat:BANalyze:SYMBOLs:EQUal` command has been set to **true**, then this command specifies the exact number of symbols a PDU must have to take part in measurement analysis.

If the `[SENSe:]DEMod:FORMat:BANalyze:SYMBOLs:EQUal` command is set to **false**, this command specifies the minimum number of symbols required for a PDU to take part in measurement analysis.

The number of data symbols is defined as the uncoded bits including service and tail bits.

**Parameters:**

<NumDataSymbols> \*RST: 1

**Example:**

```
SENS:DEMO:FORM:BANA:SYMB:MIN 1
SENS:DEMO:FORM:BANA:SYMB:EQU ON
```



Configuring the Default WLAN Measurement (Modulation Accuracy, Flatness and Tolerance)

**Manual control:** See ["No. of Data Symbols"](#) on page 83

### 9.4.9 Limits

The following commands are required to define the limits against which the individual parameter results are checked. Principally, the limits are defined in the WLAN 802.11 standards. However, you can change the limits for your own test cases and reset the limits to the standard values later. Note that changing limits is currently only possible via remote control, not manually via the user interface.

The commands required to retrieve the limit check results are described in [chapter 9.8.1.3, "Limit Check Results"](#), on page 170.

Useful commands for defining limits described elsewhere:

- [UNIT:EVM](#) on page 169
- [UNIT:GIMBalance](#) on page 170

#### Remote commands exclusive to defining limits:

<a href="#">CALCulate:LIMit:BURSt:ALL</a> .....	145
<a href="#">CALCulate:LIMit:BURSt:EVM:ALL[:AVERAge]</a> .....	146
<a href="#">CALCulate:LIMit:BURSt:EVM:ALL:MAXimum</a> .....	146
<a href="#">CALCulate:LIMit:BURSt:EVM:DATA[:AVERAge]</a> .....	146
<a href="#">CALCulate:LIMit:BURSt:EVM:DATA:MAXimum</a> .....	146
<a href="#">CALCulate:LIMit:BURSt:EVM:PILot[:AVERAge]</a> .....	146
<a href="#">CALCulate:LIMit:BURSt:EVM:PILot:MAXimum</a> .....	146
<a href="#">CALCulate:LIMit:BURSt:FERRor[:AVERAge]</a> .....	147
<a href="#">CALCulate:LIMit:BURSt:FERRor:MAXimum</a> .....	147
<a href="#">CALCulate:LIMit:BURSt:IQOFfset[:AVERAge]</a> .....	147
<a href="#">CALCulate:LIMit:BURSt:IQOFfset:MAXimum</a> .....	147
<a href="#">CALCulate:LIMit:BURSt:SYMBolerror[:AVERAge]</a> .....	147
<a href="#">CALCulate:LIMit:BURSt:SYMBolerror:MAXimum</a> .....	147

---

#### **CALCulate:LIMit:BURSt:ALL** <Limits>

This command sets or returns the limit values for the parameters determined by the default WLAN measurement (see [chapter 3.1.1, "Modulation Accuracy, Flatness and Tolerance Parameters"](#), on page 11) all in one step.

To define individual limit values use the individual `CALCulate<n>:LIMit<k>:BURSt...` commands.

Note that the units for the EVM and gain imbalance parameters must be defined in advance using the following commands:

- [UNIT:EVM](#) on page 169
- [UNIT:GIMBalance](#) on page 170

## Configuring the Default WLAN Measurement (Modulation Accuracy, Flatness and Tolerance)

**Parameters:**

&lt;Limits&gt;

The parameters are input or output as a list of (ASCII) values separated by ',' in the following order:

<average CF error>, <max CF error>, <average symbol clock error>, <max symbol clock error>, <average I/Q offset>, <maximum I/Q offset>, <average EVM all carriers>, <max EVM all carriers>, <average EVM data carriers>, <max EVM data carriers>, <average EVM pilots>, <max EVM pilots>

**CALCulate:LIMit:BURSt:EVM:ALL[:AVERAge]** <Limit>**CALCulate:LIMit:BURSt:EVM:ALL:MAXimum** <Limit>

This command sets or queries the average or maximum error vector magnitude limit for all carriers as determined by the default WLAN measurement.

For details on the EVM results and the default WLAN measurement see [chapter 3.1.1, "Modulation Accuracy, Flatness and Tolerance Parameters"](#), on page 11.

**Parameters:**

&lt;Limit&gt;

numeric value in dB

The unit for the EVM parameters can be changed in advance using [UNIT:EVM](#) on page 169.

Default unit: DB

**CALCulate:LIMit:BURSt:EVM:DATA[:AVERAge]** <Limit>**CALCulate:LIMit:BURSt:EVM:DATA:MAXimum** <Limit>

This command sets or queries the average or maximum error vector magnitude limit for the data carrier determined by the default WLAN measurement.

For details on the EVM results and the default WLAN measurement see [chapter 3.1.1, "Modulation Accuracy, Flatness and Tolerance Parameters"](#), on page 11.

**Parameters:**

&lt;Limit&gt;

numeric value in dB

The unit for the EVM parameters can be changed in advance using [UNIT:EVM](#) on page 169.

Default unit: DB

**CALCulate:LIMit:BURSt:EVM:PILot[:AVERAge]** <Limit>**CALCulate:LIMit:BURSt:EVM:PILot:MAXimum** <Limit>

This command sets or queries the maximum error vector magnitude limit for the pilot carriers determined by the default WLAN measurement.

For details on the EVM results and the default WLAN measurement see [chapter 3.1.1, "Modulation Accuracy, Flatness and Tolerance Parameters"](#), on page 11.

## Configuring the Default WLAN Measurement (Modulation Accuracy, Flatness and Tolerance)

**Parameters:**

<Limit> numeric value in dB  
 The unit for the EVM parameters can be changed in advance using [UNIT:EVM](#) on page 169.  
 Default unit: DB

**CALCulate:LIMit:BURSt:FERRor[:AVERage]** <Limit>

**CALCulate:LIMit:BURSt:FERRor:MAXimum** <Limit>

This command sets or queries the average or maximum center frequency error limit determined by the default WLAN measurement.

For details on the center frequency error results and the default WLAN measurement see [chapter 3.1.1, "Modulation Accuracy, Flatness and Tolerance Parameters"](#), on page 11.

**Parameters:**

<Limit> numeric value in Hertz  
 Default unit: HZ

**CALCulate:LIMit:BURSt:IQOFFset[:AVERage]** <Limit>

**CALCulate:LIMit:BURSt:IQOFFset:MAXimum** <Limit>

This command sets or queries the average or maximum I/Q offset error limit determined by the default WLAN measurement..

For details on the I/Q offset and the default WLAN measurement see [chapter 3.1.1, "Modulation Accuracy, Flatness and Tolerance Parameters"](#), on page 11.

**Parameters:**

<Limit> Range: -1000000 to 1000000  
 Default unit: DB

**CALCulate:LIMit:BURSt:SYMBOLerror[:AVERage]** <Limit>

**CALCulate:LIMit:BURSt:SYMBOLerror:MAXimum** <Limit>

This command sets or queries the average or maximum symbol clock error limit determined by the default WLAN measurement.

For details on the symbol clock error and the default WLAN measurement see [chapter 3.1.1, "Modulation Accuracy, Flatness and Tolerance Parameters"](#), on page 11.

**Parameters:**

<Limit> numeric value in parts per million  
 Default unit: PPM

### 9.4.10 Automatic Settings

[SENSe:]ADJust:CONFigure:DURation.....	148
[SENSe:]ADJust:CONFigure:DURation:MODE.....	148
[SENSe:]ADJust:CONFigure:HYSteresis:LOWer.....	149
[SENSe:]ADJust:CONFigure:HYSteresis:UPPer.....	149
[SENSe:]ADJust:LEVel.....	149

---

#### [SENSe:]ADJust:CONFigure:DURation <Duration>

In order to determine the ideal reference level, the R&S FSW performs a measurement on the current input data. This command defines the length of the measurement if [SENSe:]ADJust:CONFigure:DURation:MODE is set to MANual.

##### Parameters:

<Duration>            Numeric value in seconds  
 Range:            0.001 to 16000.0  
 \*RST:            0.001  
 Default unit: s

##### Example:

```
ADJ:CONF:DUR:MODE MAN
Selects manual definition of the measurement length.
ADJ:CONF:LEV:DUR 5ms
Length of the measurement is 5 ms.
```

**Manual control:** See ["Changing the Automatic Measurement Time \(Meastime Manual\)"](#) on page 86

---

#### [SENSe:]ADJust:CONFigure:DURation:MODE <Mode>

In order to determine the ideal reference level, the R&S FSW performs a measurement on the current input data. This command selects the way the R&S FSW determines the length of the measurement .

##### Parameters:

<Mode>            **AUTO**  
 The R&S FSW determines the measurement length automatically according to the current input data.

**MANual**  
 The R&S FSW uses the measurement length defined by [SENSe:]ADJust:CONFigure:DURation on page 148.  
 \*RST:            AUTO

**Manual control:** See ["Resetting the Automatic Measurement Time \(Meastime Auto\)"](#) on page 86  
 See ["Changing the Automatic Measurement Time \(Meastime Manual\)"](#) on page 86

**[SENSe:]ADJust:CONFigure:HYSTeresis:LOWer <Threshold>**

When the reference level is adjusted automatically using the `[SENSe:]ADJust:LEVel` on page 149 command, the internal attenuators and the preamplifier are also adjusted. In order to avoid frequent adaptation due to small changes in the input signal, you can define a hysteresis. This setting defines a lower threshold the signal must fall below (compared to the last measurement) before the reference level is adapted automatically.

**Parameters:**

<Threshold>            Range:        0 dB to 200 dB  
                           \*RST:        +1 dB  
                           Default unit: dB

**Example:**

`SENS:ADJ:CONF:HYST:LOW 2`

For an input signal level of currently 20 dBm, the reference level will only be adjusted when the signal level falls below 18 dBm.

**Manual control:**    See "[Lower Level Hysteresis](#)" on page 86

**[SENSe:]ADJust:CONFigure:HYSTeresis:UPPer <Threshold>**

When the reference level is adjusted automatically using the `[SENSe:]ADJust:LEVel` on page 149 command, the internal attenuators and the preamplifier are also adjusted. In order to avoid frequent adaptation due to small changes in the input signal, you can define a hysteresis. This setting defines an upper threshold the signal must exceed (compared to the last measurement) before the reference level is adapted automatically.

**Parameters:**

<Threshold>            Range:        0 dB to 200 dB  
                           \*RST:        +1 dB  
                           Default unit: dB

**Example:**

`SENS:ADJ:CONF:HYST:UPP 2`

**Example:**

For an input signal level of currently 20 dBm, the reference level will only be adjusted when the signal level rises above 22 dBm.

**Manual control:**    See "[Upper Level Hysteresis](#)" on page 86

**[SENSe:]ADJust:LEVel**

This command initiates a single (internal) measurement that evaluates and sets the ideal reference level for the current input data and measurement settings. This ensures that the settings of the RF attenuation and the reference level are optimally adjusted to the signal level without overloading the R&S FSW or limiting the dynamic range by an S/N ratio that is too small.

**Example:**            `ADJ:LEV`

**Usage:**              Event

**Manual control:** See ["Reference Level"](#) on page 63  
 See ["Setting the Reference Level Automatically \(Auto Level\)"](#)  
 on page 64

### 9.4.11 Sweep Settings

[\[SENSe:\]SWEep:COUNT](#)..... 150

---

**[SENSe:]SWEep:COUNT** <SweepCount>

This command defines the number of sweeps the R&S FSW uses to average traces.

In case of continuous sweeps, the R&S FSW calculates the moving average over the average count.

In case of single sweep measurements, the R&S FSW stops the measurement and calculates the average after the average count has been reached.

**Example:**

```
SWE:COUN 64
Sets the number of sweeps to 64.
INIT:CONT OFF
Switches to single sweep mode.
INIT;*WAI
Starts a sweep and waits for its end.
```

**Usage:** SCPI confirmed

## 9.5 Configuring Measurements on RF Data from WLAN Signals

The R&S FSW WLAN application uses the functionality of the FSW base system (Spectrum application, see the R&S FSW User Manual) to perform the WLAN measurements on RF data. The R&S FSW WLAN application automatically sets the parameters to predefined settings as described in [chapter 5.4, "RF \(Frequency Domain\) Measurements"](#), on page 89.

The WLAN RF measurements must be activated for a measurement channel in the WLAN application, see [chapter 9.2, "Activating WLAN Measurements"](#), on page 104.

For details on configuring these RF measurements in a remote environment, see the Remote Commands chapter of the R&S FSW User Manual.

## 9.6 Configuring the Result Display

The following commands are required to configure the screen display in a remote environment. The corresponding tasks for manual operation are described in [chapter 5.2, "Display Configuration"](#), on page 52.



The suffix <n> in the following remote commands represents the window (1..16) in the currently selected measurement channel.

- [General Window Commands](#).....151
- [Working with Windows in the Display](#).....152
- [Selecting Items to Display in Result Summary](#).....158

### 9.6.1 General Window Commands

The following commands are required to configure general window layout, independent of the application.

Note that the suffix <n> always refers to the window *in the currently selected measurement channel* (see [INSTrument\[:SElect\]](#) on page 107).

<a href="#">DISPlay:FORMat</a> .....	151
<a href="#">DISPlay[:WINDow&lt;n&gt;]:SIZE</a> .....	151
<a href="#">DISPlay[:WINDow&lt;n&gt;]:SElect</a> .....	152

#### **DISPlay:FORMat** <Format>

This command determines which tab is displayed.

##### **Parameters:**

<Format>

##### **SPLit**

Displays the MultiView tab with an overview of all active channels

##### **SINGLE**

Displays the measurement channel that was previously focused.

\*RST: SPL

##### **Example:**

DISP:FORM SING

#### **DISPlay[:WINDow<n>]:SIZE** <Size>

This command maximizes the size of the selected result display window *temporarily*. To change the size of several windows on the screen permanently, use the [LAYout:SPLitter](#) command (see [LAYout:SPLitter](#) on page 155).

##### **Parameters:**

<Size>

##### **LARGE**

Maximizes the selected window to full screen.  
Other windows are still active in the background.

##### **SMALI**

Reduces the size of the selected window to its original size.  
If more than one measurement window was displayed originally, these are visible again.

\*RST: SMALI

##### **Example:**

DISP:WIND2:LARG

**DISPlay[:WINDow<n>]:SElect**

This command sets the focus on the selected result display window.

This window is then the active window.

**Example:**                   DISP:WIND1:SEL  
Sets the window 1 active.

**Usage:**                    Setting only

**9.6.2 Working with Windows in the Display**

The following commands are required to change the evaluation type and rearrange the screen layout for a measurement channel as you do using the SmartGrid in manual operation. Since the available evaluation types depend on the selected application, some parameters for the following commands also depend on the selected measurement channel.

Note that the suffix <n> always refers to the window *in the currently selected measurement channel* (see [INSTrument\[:SElect\]](#) on page 107).

<a href="#">LAYout:ADD[:WINDow]?</a> .....	152
<a href="#">LAYout:CATalog[:WINDow]?</a> .....	154
<a href="#">LAYout:IDENtify[:WINDow]?</a> .....	154
<a href="#">LAYout:REMove[:WINDow]</a> .....	155
<a href="#">LAYout:REPLace[:WINDow]</a> .....	155
<a href="#">LAYout:SPLitter</a> .....	155
<a href="#">LAYout:WINDow&lt;n&gt;:ADD?</a> .....	157
<a href="#">LAYout:WINDow&lt;n&gt;:IDENtify?</a> .....	157
<a href="#">LAYout:WINDow&lt;n&gt;:REMove</a> .....	157
<a href="#">LAYout:WINDow&lt;n&gt;:REPLace</a> .....	158

**LAYout:ADD[:WINDow]? <WindowName>,<Direction>,<WindowType>**

This command adds a window to the display.

This command is always used as a query so that you immediately obtain the name of the new window as a result.

To replace an existing window, use the [LAYout:REPLace\[:WINDow\]](#) command.

**Parameters:**

<WindowName>	String containing the name of the existing window the new window is inserted next to. By default, the name of a window is the same as its index. To determine the name and index of all active windows, use the <a href="#">LAYout:CATalog[:WINDow]?</a> query.
<Direction>	LEFT   RIGHT   ABOVE   BELOW Direction the new window is added relative to the existing window.



<WindowType> text value  
 Type of result display (evaluation method) you want to add.  
 See the table below for available parameter values.

**Return values:**

<NewWindowName> When adding a new window, the command returns its name (by default the same as its number) as a result.

**Example:**

```
LAY:ADD? '1', LEFT, MTAB
```

Result:

```
'2'
```

Adds a new window named '2' with a marker table to the left of window 1.

**Usage:** Query only

**Manual control:** See ["Bitstream"](#) on page 17  
 See ["Constellation"](#) on page 17  
 See ["Constellation vs Carrier"](#) on page 18  
 See ["EVM vs Carrier"](#) on page 19  
 See ["EVM vs Symbol"](#) on page 19  
 See ["FFT Spectrum"](#) on page 20  
 See ["Group Delay"](#) on page 21  
 See ["Magnitude Capture"](#) on page 21  
 See ["PvT Full PPDU"](#) on page 22  
 See ["Result Summary Detailed"](#) on page 22  
 See ["Result Summary Global"](#) on page 24  
 See ["Signal Field"](#) on page 24  
 See ["Spectrum Flatness"](#) on page 27  
 See ["Diagram"](#) on page 32  
 See ["Result Summary"](#) on page 33  
 See ["Marker Table"](#) on page 33  
 See ["Marker Peak List"](#) on page 33

**Table 9-5: <WindowType> parameter values for WLAN application**

Parameter value	Window type
<b>Window types for I/Q data</b>	
BITStream	Bitstream
CMEemory	Magnitude Capture
CONStellation	Constellation
CVCARRIER	Constellation vs Carrier
EVCARRIER	EVM vs Carrier
EVSymbol	EVM vs Symbol
FSPpectrum	FFT Spectrum
GDElay	Group Delay
RSDetailed	Result Summary Detailed
RSGlobal	Result Summary Global

Parameter value	Window type
SField	Signal Field
SFlatness	Spectrum Flatness
PFPPdu	PvT Full PPDU
<b>Window types for RF data</b>	
DIAGram	Diagram (SEM, ACLR)
MTABle	Marker table (SEM, ACLR)
PEAKlist	Marker peak list (SEM, ACLR)
RSUMmary	Result summary (SEM, ACLR)

---

### LAYout:CATalog[:WINDow]?

This command queries the name and index of all active windows from top left to bottom right. The result is a comma-separated list of values for each window, with the syntax:

<WindowName\_1>,<Index\_1>..<WindowName\_n>,<Index\_n>

#### Return values:

<WindowName>      string  
 Name of the window.  
 In the default state, the name of the window is its index.

<Index>            **numeric value**  
 Index of the window.

#### Example:

LAY:CAT?

Result:

'2',2,'1',1

Two windows are displayed, named '2' (at the top or left), and '1' (at the bottom or right).

**Usage:**            Query only

---

### LAYout:IDENTify[:WINDow]? <WindowName>

This command queries the **index** of a particular display window.

**Note:** to query the **name** of a particular window, use the `LAYout:WINDow<n>:IDENTify?` query.

#### Query parameters:

<WindowName>      String containing the name of a window.

#### Return values:

<WindowIndex>     Index number of the window.

**Usage:**            Query only

---

**LAYout:REMove[:WINDow] <WindowName>**

This command removes a window from the display.

**Parameters:**

<WindowName> String containing the name of the window.  
In the default state, the name of the window is its index.

**Usage:** Event

---

**LAYout:REPLace[:WINDow] <WindowName>,<WindowType>**

This command replaces the window type (for example from "Diagram" to "Result Summary") of an already existing window while keeping its position, index and window name.

To add a new window, use the [LAYout:ADD\[:WINDow\]?](#) command.

**Parameters:**

<WindowName> String containing the name of the existing window.  
By default, the name of a window is the same as its index. To determine the name and index of all active windows, use the [LAYout:CATalog\[:WINDow\]?](#) query.

<WindowType> Type of result display you want to use in the existing window.  
See [LAYout:ADD\[:WINDow\]?](#) on page 152 for a list of available window types.

**Example:** `LAY:REPL:WIND '1',MTAB`  
Replaces the result display in window 1 with a marker table.

---

**LAYout:SPLitter <Index1>,<Index2>,<Position>**

This command changes the position of a splitter and thus controls the size of the windows on each side of the splitter.

As opposed to the [DISPlay\[:WINDow<n>\]:SIZE](#) on page 151 command, the `LAYout:SPLitter` changes the size of all windows to either side of the splitter permanently, it does not just maximize a single window temporarily.

Note that windows must have a certain minimum size. If the position you define conflicts with the minimum size of any of the affected windows, the command will not work, but does not return an error.

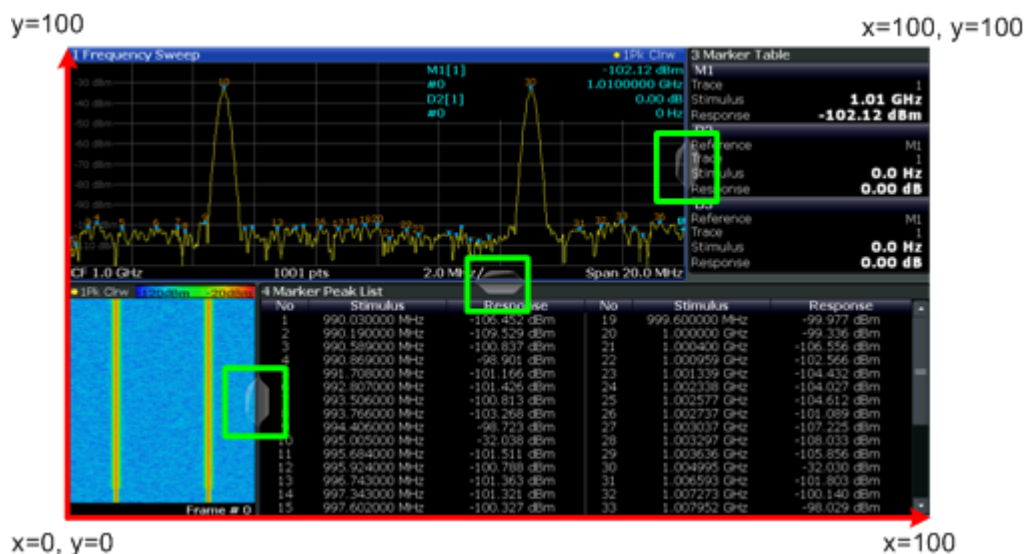

Fig. 9-1: SmartGrid coordinates for remote control of the splitters

#### Parameters:

- <Index1> The index of one window the splitter controls.
- <Index2> The index of a window on the other side of the splitter.
- <Position> New vertical or horizontal position of the splitter as a fraction of the screen area (without channel and status bar and softkey menu). The point of origin ( $x = 0$ ,  $y = 0$ ) is in the lower left corner of the screen. The end point ( $x = 100$ ,  $y = 100$ ) is in the upper right corner of the screen. (See figure 9-1.)
- The direction in which the splitter is moved depends on the screen layout. If the windows are positioned horizontally, the splitter also moves horizontally. If the windows are positioned vertically, the splitter also moves vertically.

Range: 0 to 100

#### Example:

LAY:SPL 1, 3, 50

Moves the splitter between window 1 ('Frequency Sweep') and 3 ('Marker Table') to the center (50%) of the screen, i.e. in the figure above, to the left.

#### Example:

LAY:SPL 1, 4, 70

Moves the splitter between window 1 ('Frequency Sweep') and 3 ('Marker Peak List') towards the top (70%) of the screen. The following commands have the exact same effect, as any combination of windows above and below the splitter moves the splitter vertically.

LAY:SPL 3, 2, 70

LAY:SPL 4, 1, 70

LAY:SPL 2, 1, 70

**LAYout:WINDow<n>:ADD?** <Direction>,<WindowType>

This command adds a measurement window to the display. Note that with this command, as opposed to [LAYout:ADD\[:WINDow\]?](#), the suffix <n> determines the existing window next to which the new window is added.

To replace an existing window, use the [LAYout:WINDow<n>:REPLace](#) command.

This command is always used as a query so that you immediately obtain the name of the new window as a result.

**Parameters:**

<Direction> LEFT | RIGHT | ABOVE | BELOW

<WindowType> Type of measurement window you want to add.  
See [LAYout:ADD\[:WINDow\]?](#) on page 152 for a list of available window types.

**Return values:**

<NewWindowName> When adding a new window, the command returns its name (by default the same as its number) as a result.

**Example:**

```
LAY:WIND1:ADD? LEFT,MTAB
```

```
Result:
```

```
'2'
```

Adds a new window named '2' with a marker table to the left of window 1.

**Usage:**

Query only

**LAYout:WINDow<n>:IDENTify?**

This command queries the **name** of a particular display window (indicated by the <n> suffix).

**Note:** to query the **index** of a particular window, use the [LAYout:IDENTify\[:WINDow\]?](#) command.

**Return values:**

<WindowName> String containing the name of a window.  
In the default state, the name of the window is its index.

**Usage:**

Query only

**LAYout:WINDow<n>:REMOve**

This command removes the window specified by the suffix <n> from the display.

The result of this command is identical to the [LAYout:REMOve\[:WINDow\]](#) command.

**Usage:**

Event

**LAYout:WINDow<n>:REPLace** <WindowType>

This command changes the window type of an existing window (specified by the suffix <n>).

The result of this command is identical to the `LAYout:REPLace[:WINDow]` command.

To add a new window, use the `LAYout:WINDow<n>:ADD?` command.

**Parameters:**

<WindowType>      Type of measurement window you want to replace another one with.  
See `LAYout:ADD[:WINDow]?` on page 152 for a list of available window types.

**9.6.3 Selecting Items to Display in Result Summary**

The following command defines which items are displayed in the Result Summary.

**DISPlay[:WINDow<n>]:TABLe:ITEM** <Item>,<State>

Defines which items are *displayed* in the Result Summary (see "[Result Summary Detailed](#)" on page 22 and "[Result Summary Global](#)" on page 24). Note that the results are always *calculated*, regardless of their visibility in the Result Summary.

**Parameters:**

<Item>              Item to be included in Result Summary. For an overview of possible results and the required parameters see the tables below.

<State>              ON | OFF

**ON**  
Item is displayed in Result Summary.

**OFF**  
Item is not displayed in Result Summary.

\*RST:                ON

**Table 9-6: Parameters for the items of the "Result Summary Detailed"**

Result in table	SCPI parameter
<b>TX channel ("Tx All")</b>	TALL
I/Q Offset	IOFSset
Gain imbalance	GIMBalance
Quadrature offset	QOFFset
PPDU power	TPPower
Crest factor	TCFactor
<b>Receive channel ("Rx All")</b>	RALL
PPDU power	RPPower
Crest factor	RCFactor

Result in table	SCPI parameter
Bitstream ("Stream All")	SALL
Pilot bit error rate	BPIlot
EVM all carriers	SEACarriers
EVM data carriers	SEDCarriers
EVM pilot carriers	SEPCarriers

**Table 9-7: Parameters for the items of the "Result Summary Global"**

Result in table	SCPI parameter
Pilot bit error rate	PBERate
EVM all carriers	EACarriers
EVM data carriers	EDCarriers
EVM pilot carriers	EPCarriers
Center frequency error	CFERror
Symbol clock error	SCERror

## 9.7 Starting a Measurement

When a WLAN measurement channel is activated on the R&S FSW, a default WLAN measurement (Modulation Accuracy, Flatness and Tolerance, see [chapter 3.1, "Default WLAN Measurement \(Modulation Accuracy, Flatness and Tolerance\)"](#), on page 11), is started immediately. However, you can stop and start a new measurement any time.

Furthermore, you can perform a sequence of measurements using the Sequencer (see [chapter 5.1, "Multiple Measurement Channels and Sequencer Function"](#), on page 50).

ABORt.....	159
INITiate:CONMeas.....	160
INITiate:CONTinuous.....	161
INITiate[:IMMediate].....	161
INITiate:SEQuencer:ABORt.....	162
INITiate:SEQuencer:IMMediate.....	162
INITiate:SEQuencer:MODE.....	162
SYSTem:SEQuencer.....	163

### ABORt

This command aborts a current measurement and resets the trigger system.

To prevent overlapping execution of the subsequent command before the measurement has been aborted successfully, use the \*OPC? or \*WAI command after ABOR and before the next command.

For details see the "Remote Basics" chapter in the R&S FSW User Manual.

To abort a sequence of measurements by the Sequencer, use the `INITiate:SEQuencer:ABORt` on page 162 command.

**Note on blocked remote control programs:**

If a sequential command cannot be completed, for example because a triggered sweep never receives a trigger, the remote control program will never finish and the remote channel (GPIB, LAN or other interface) to the R&S FSW is blocked for further commands. In this case, you must interrupt processing on the remote channel first in order to abort the measurement.

To do so, send a "Device Clear" command from the control instrument to the R&S FSW on a parallel channel to clear all currently active remote channels. Depending on the used interface and protocol, send the following commands:

- **Visa:** `viClear()`
- **GPIB:** `ibclr()`
- **RSIB:** `RSDLLibclr()`

Now you can send the `ABORt` command on the remote channel performing the measurement.

**Example:** `ABOR; :INIT:IMM`  
Aborts the current measurement and immediately starts a new one.

**Example:** `ABOR; *WAI`  
`INIT:IMM`  
Aborts the current measurement and starts a new one once abortion has been completed.

**Usage:** SCPI confirmed

---

**INITiate:CONMeas**

This command restarts a (single) measurement that has been stopped (using `INIT:CONT OFF`) or finished in single sweep mode.

The measurement is restarted at the beginning, not where the previous measurement was stopped.

As opposed to `INITiate[:IMMEDIATE]`, this command does not reset traces in maxhold, minhold or average mode. Therefore it can be used to continue measurements using maxhold or averaging functions.



**Example:** (for Spectrum application:)  
 INIT:CONT OFF  
 Switches to single sweep mode.  
 DISP:WIND:TRAC:MODE AVER  
 Switches on trace averaging.  
 SWE:COUN 20  
 Setting the sweep counter to 20 sweeps.  
 INIT;\*WAI  
 Starts the measurement and waits for the end of the 20 sweeps.  
 INIT:CONM;\*WAI  
 Continues the measurement (next 20 sweeps) and waits for the end.  
 Result: Averaging is performed over 40 sweeps.

**Manual control:** See ["Continue Single Sweep"](#) on page 88

#### INITiate:CONTinuous <State>

This command controls the sweep mode.

Note that in single sweep mode, you can synchronize to the end of the measurement with \*OPC, \*OPC? or \*WAI. In continuous sweep mode, synchronization to the end of the measurement is not possible. Thus, it is not recommended that you use continuous sweep mode in remote control, as results like trace data or markers are only valid after a single sweep end synchronization.

For details on synchronization see the "Remote Basics" chapter in the R&S FSW User Manual.

If the sweep mode is changed for a measurement channel while the Sequencer is active (see [INITiate:SEQuencer:IMMediate](#) on page 162) the mode is only considered the next time the measurement in that channel is activated by the Sequencer.

#### Parameters:

<State>            ON | OFF  
**ON**  
 Continuous sweep  
**OFF**  
 Single sweep  
 \*RST:            ON

**Example:**            INIT:CONT OFF  
 Switches the sweep mode to single sweep.  
 INIT:CONT ON  
 Switches the sweep mode to continuous sweep.

**Manual control:** See ["Continuous Sweep/RUN CONT"](#) on page 87

#### INITiate[:IMMediate]

This command starts a (single) new measurement.

You can synchronize to the end of the measurement with \*OPC, \*OPC? or \*WAI.

For details on synchronization see the "Remote Basics" chapter in the R&S FSW User Manual.

**Example:** (For Spectrum application:)  
 INIT:CONT OFF  
 Switches to single sweep mode.  
 DISP:WIND:TRAC:MODE AVER  
 Switches on trace averaging.  
 SWE:COUN 20  
 Sets the sweep counter to 20 sweeps.  
 INIT;\*WAI  
 Starts the measurement and waits for the end of the 20 sweeps.

**Manual control:** See "Single Sweep/ RUN SINGLE" on page 87

#### INITiate:SEQuencer:ABORt

This command stops the currently active sequence of measurements. The Sequencer itself is not deactivated, so you can start a new sequence immediately using [INITiate:SEQuencer:IMMediate](#) on page 162.

To deactivate the Sequencer use [SYSTem:SEQuencer](#) on page 163.

**Usage:** Event

**Manual control:** See "Sequencer State" on page 51

#### INITiate:SEQuencer:IMMediate

This command starts a new sequence of measurements by the Sequencer. Its effect is similar to the [INITiate\[:IMMediate\]](#) command used for a single measurement.

Before this command can be executed, the Sequencer must be activated (see [SYSTem:SEQuencer](#) on page 163).

**Example:** SYST:SEQ ON  
 Activates the Sequencer.  
 INIT:SEQ:MODE SING  
 Sets single Sequencer mode so each active measurement will be performed once.  
 INIT:SEQ:IMM  
 Starts the sequential measurements.

**Usage:** Event

**Manual control:** See "Sequencer State" on page 51

#### INITiate:SEQuencer:MODE <Mode>

This command selects the way the R&S FSW application performs measurements sequentially.

Before this command can be executed, the Sequencer must be activated (see [SYSTem:SEQuencer](#) on page 163).

A detailed programming example is provided in the "Operating Modes" chapter in the R&S FSW User Manual.

**Note:** In order to synchronize to the end of a sequential measurement using \*OPC, \*OPC? or \*WAI you must use `SINGle` Sequencer mode.

For details on synchronization see the "Remote Basics" chapter in the R&S FSW User Manual.

**Parameters:**

<Mode>

**SINGle**

Each measurement is performed once (regardless of the channel's sweep mode), considering each channels' sweep count, until all measurements in all active channels have been performed.

**CONTInuous**

The measurements in each active channel are performed one after the other, repeatedly (regardless of the channel's sweep mode), in the same order, until the Sequencer is stopped.

**CDEFined**

First, a single sequence is performed. Then, only those channels in continuous sweep mode (`INIT:CONT ON`) are repeated.

\*RST:       CONTInuous

**Example:**

`SYST:SEQ ON`

Activates the Sequencer.

`INIT:SEQ:MODE SING`

Sets single Sequencer mode so each active measurement will be performed once.

`INIT:SEQ:IMM`

Starts the sequential measurements.

**Manual control:**    See "[Sequencer Mode](#)" on page 51

---

**SYSTem:SEQuencer <State>**

This command turns the Sequencer on and off. The Sequencer must be active before any other Sequencer commands (`INIT:SEQ. . .`) are executed, otherwise an error will occur.

A detailed programming example is provided in the "Operating Modes" chapter in the R&S FSW User Manual.

**Parameters:**

&lt;State&gt;

ON | OFF

**ON**

The Sequencer is activated and a sequential measurement is started immediately.

**OFF**

The Sequencer is deactivated. Any running sequential measurements are stopped. Further Sequencer commands (INIT:SEQ...) are not available.

\*RST: OFF

**Example:**

SYST:SEQ ON

Activates the Sequencer.

INIT:SEQ:MODE SING

Sets single Sequencer mode so each active measurement will be performed once.

INIT:SEQ:IMM

Starts the sequential measurements.

SYST:SEQ OFF

**Manual control:**See "[Sequencer State](#)" on page 51

## 9.8 Retrieving Results

The following commands are required to retrieve the results from a WLAN measurement in a remote environment.



The \*OPC command should be used after commands that retrieve data so that subsequent commands to change the trigger or data capturing settings are held off until after the data capture is completed and the data has been returned.

- [Numeric Modulation Accuracy, Flatness and Tolerance Results](#)..... 164
- [Numeric Results for RF Data](#)..... 172
- [Retrieving Trace Results](#)..... 176
- [Measurement Results for TRACe<n>\[:DATA\]? TRACE<n>](#)..... 179
- [Importing and Exporting I/Q Data and Results](#)..... 186

### 9.8.1 Numeric Modulation Accuracy, Flatness and Tolerance Results

The following commands describe how to retrieve the numeric results from the standard WLAN measurements.



The commands to retrieve results from measurements on RF data for WLAN signals are described in [chapter 9.8.2, "Numeric Results for RF Data"](#), on page 172.

- [PPDU and Symbol Count Results](#).....165
- [Error Parameter Results](#).....165
- [Limit Check Results](#).....170

### 9.8.1.1 PPDU and Symbol Count Results

The following commands are required to retrieve PPDU and symbol count results from the default WLAN measurement on the captured I/Q data (see [chapter 3.1.1, "Modulation Accuracy, Flatness and Tolerance Parameters"](#), on page 11).

<a href="#">FETCh:BURSt:COUNt?</a> .....	165
<a href="#">FETCh:BURSt:COUNt:ALL?</a> .....	165
<a href="#">FETCh:SYMBol:COUNt?</a> .....	165

---

#### FETCh:BURSt:COUNt?

This command returns the number of analyzed PPDU's from the current capture buffer. If multiple measurements are required because the number of PPDU's to analyze is greater than the number of PPDU's that can be captured in one buffer, this command only returns the number of captured PPDU's *in the current capture buffer* (as opposed to [FETCh:BURSt:COUNt:ALL?](#)).

**Usage:** Query only

---

#### FETCh:BURSt:COUNt:ALL?

This command returns the number of analyzed PPDU's for the entire measurement. If multiple measurements are required because the number of PPDU's to analyze is greater than the number of PPDU's that can be captured in one buffer, this command returns the number of analyzed PPDU's in *all* measurements (as opposed to [FETCh:BURSt:COUNt?](#)).

**Usage:** Query only

---

#### FETCh:SYMBol:COUNt?

This command returns the number of symbols in each analyzed PPDU as a comma separated list. The length of the list corresponds to the number of PPDU's, i.e. the result of [FETCh:BURSt:COUNt:ALL?](#).

**Usage:** Query only

### 9.8.1.2 Error Parameter Results

The following commands are required to retrieve individual results from the default WLAN measurement on the captured I/Q data (see [chapter 3.1.1, "Modulation Accuracy, Flatness and Tolerance Parameters"](#), on page 11).

FETCh:BURSt:ALL.....	166
FETCh:BURSt:CRESt[:AVERAge]?	167
FETCh:BURSt:CRESt:MAXimum?	167
FETCh:BURSt:CRESt:MINimum?	167
FETCh:BURSt:EVM:ALL:AVERAge?	167
FETCh:BURSt:EVM:ALL:MAXimum?	167
FETCh:BURSt:EVM:ALL:MINimum?	167
FETCh:BURSt:EVM:DATA:AVERAge?	167
FETCh:BURSt:EVM:DATA:MAXimum?	167
FETCh:BURSt:EVM:DATA:MINimum?	167
FETCh:BURSt:EVM:PILOt:AVERAge?	168
FETCh:BURSt:EVM:PILOt:MAXimum?	168
FETCh:BURSt:EVM:PILOt:MINimum?	168
FETCh:BURSt:FERRor:AVERAge?	168
FETCh:BURSt:FERRor:MAXimum?	168
FETCh:BURSt:FERRor:MINimum?	168
FETCh:BURSt:GIMBalance:AVERAge?	168
FETCh:BURSt:GIMBalance:MAXimum?	168
FETCh:BURSt:GIMBalance:MINimum?	168
FETCh:BURSt:IQOFset:AVERAge?	168
FETCh:BURSt:IQOFset:MAXimum?	168
FETCh:BURSt:IQOFset:MINimum?	168
FETCh:BURSt:PAYLoad?	168
FETCh:BURSt:PEAK?	169
FETCh:BURSt:PREAmble?	169
FETCh:BURSt:QUADoffset:AVERAge?	169
FETCh:BURSt:QUADoffset:MAXimum?	169
FETCh:BURSt:QUADoffset:MINimum?	169
FETCh:BURSt:RMS[:AVERAge]?	169
FETCh:BURSt:RMS:MAXimum?	169
FETCh:BURSt:RMS:MINimum?	169
FETCh:BURSt:SYMBOLerror:AVERAge	169
FETCh:BURSt:SYMBOLerror:MAXimum	169
FETCh:BURSt:SYMBOLerror:MINimum	169
UNIT:EVM.....	169
UNIT:GIMBalance.....	170

---

### FETCh:BURSt:ALL

This command returns all results from the default WLAN measurement (Modulation Accuracy, Flatness and Tolerance, see [chapter 3.1.1, "Modulation Accuracy, Flatness and Tolerance Parameters"](#), on page 11). The results are output as a list of result strings separated by commas in ASCII format. The results are output in the following order:

**Return values:**

<Results>                    <preamble power>, <payload power>, <min rms power>, <average rms power>, <max rms power>, <peak power>, <min crest factor>, <average crest factor>, <max crest factor>, <min frequency error>, <average frequency error>, <max frequency error>, <min symbol error>, <average symbol error>, <max symbol error>, <min IQ offset>, <average IQ offset>, <maximum IQ offset>, <min gain imbalance>, <average gain imbalance>, <max gain imbalance>, <min quadrature offset>, <average quadrature offset>, <max quadrature offset>, <min EVM all bursts>, <average EVM all bursts>, <max EVM all bursts>, <min EVM data carriers>, <average EVM data carriers >, <max EVM data carriers> <min EVM pilots>, <average EVM pilots >, <max EVM pilots>

**FETCh:BURSt:CRESt[:AVERAge]?****FETCh:BURSt:CRESt:MAXimum?****FETCh:BURSt:CRESt:MINimum?**

This command returns the average, maximum or minimum determined CREST factor (= ratio of peak power to average power) in dB.

For details see [chapter 3.1.1, "Modulation Accuracy, Flatness and Tolerance Parameters"](#), on page 11

**Usage:**                    Query only

**FETCh:BURSt:EVM:ALL:AVERAge?****FETCh:BURSt:EVM:ALL:MAXimum?****FETCh:BURSt:EVM:ALL:MINimum?**

This command returns the average, maximum or minimum EVM in dB. This is a combined figure that represents the pilot, data and the free carrier.

For details see [chapter 3.1.1, "Modulation Accuracy, Flatness and Tolerance Parameters"](#), on page 11

**Usage:**                    Query only

**FETCh:BURSt:EVM:DATA:AVERAge?****FETCh:BURSt:EVM:DATA:MAXimum?****FETCh:BURSt:EVM:DATA:MINimum?**

This command returns the average, maximum or minimum EVM for the data carrier in dB.

For details see [chapter 3.1.1, "Modulation Accuracy, Flatness and Tolerance Parameters"](#), on page 11

**Usage:**                    Query only

---

**FETCh:BURSt:EVM:PILot:AVERage?**  
**FETCh:BURSt:EVM:PILot:MAXimum?**  
**FETCh:BURSt:EVM:PILot:MINimum?**

This command returns the average, maximum or minimum EVM in dB for the pilot carrier.

For details see [chapter 3.1.1, "Modulation Accuracy, Flatness and Tolerance Parameters"](#), on page 11

**Usage:** Query only

---

**FETCh:BURSt:FERRor:AVERage?**  
**FETCh:BURSt:FERRor:MAXimum?**  
**FETCh:BURSt:FERRor:MINimum?**

This command returns the average, maximum or minimum center frequency errors in Hertz.

For details see [chapter 3.1.1, "Modulation Accuracy, Flatness and Tolerance Parameters"](#), on page 11

**Usage:** Query only

---

**FETCh:BURSt:GIMBalance:AVERage?**  
**FETCh:BURSt:GIMBalance:MAXimum?**  
**FETCh:BURSt:GIMBalance:MINimum?**

This command returns the average, maximum or minimum I/Q imbalance in dB.

For details see [chapter 3.1.1, "Modulation Accuracy, Flatness and Tolerance Parameters"](#), on page 11

**Usage:** Query only

---

**FETCh:BURSt:IQOFfset:AVERage?**  
**FETCh:BURSt:IQOFfset:MAXimum?**  
**FETCh:BURSt:IQOFfset:MINimum?**

This command returns the average, maximum or minimum I/Q offset in dB.

For details see [chapter 3.1.1, "Modulation Accuracy, Flatness and Tolerance Parameters"](#), on page 11

**Usage:** Query only

---

**FETCh:BURSt:PAYLoad?**

This command returns the average power measured in the payload of all analyzed PPDUs.

**Usage:** Query only



---

**FETCH:BURSt:PEAK?**

This command returns the Peak power in dBm measured during the measurement time.

**Usage:** Query only

---

**FETCH:BURSt:PREAmble?**

This command returns the average power measured in all analyzed PPDU preambles.

**Usage:** Query only

---

**FETCH:BURSt:QUADoffset:AVERAge?**  
**FETCH:BURSt:QUADoffset:MAXimum?**  
**FETCH:BURSt:QUADoffset:MINimum?**

This command returns the average, maximum or minimum quadrature offset of symbols within a PPDU. This value indicates the phase accuracy.

For details see [chapter 3.1.1, "Modulation Accuracy, Flatness and Tolerance Parameters"](#), on page 11.

**Usage:** Query only

---

**FETCH:BURSt:RMS[:AVERAge]?**  
**FETCH:BURSt:RMS:MAXimum?**  
**FETCH:BURSt:RMS:MINimum?**

This command returns the average, maximum or minimum RMS power in dBm for all analyzed PPDUs.

For details see [chapter 3.1.1, "Modulation Accuracy, Flatness and Tolerance Parameters"](#), on page 11.

**Usage:** Query only

---

**FETCH:BURSt:SYMBolerror:AVERAge**  
**FETCH:BURSt:SYMBolerror:MAXimum**  
**FETCH:BURSt:SYMBolerror:MINimum**

This command returns the average, maximum or minimum percentage of symbols that were outside the allowed demodulation range within a PPDU.

For details see [chapter 3.1.1, "Modulation Accuracy, Flatness and Tolerance Parameters"](#), on page 11.

---

**UNIT:EVM <Unit>**

This command specifies the units for EVM limits and results (see [chapter 3.1.1, "Modulation Accuracy, Flatness and Tolerance Parameters"](#), on page 11).

**Parameters:**

<Unit> DB | PCT  
 \*RST: DB

**UNIT:GIMBalance** <Unit>

This command specifies the units for gain imbalance results (see [chapter 3.1.1, "Modulation Accuracy, Flatness and Tolerance Parameters"](#), on page 11).

**Parameters:**

<Unit> DB | PCT  
 \*RST: DB

**9.8.1.3 Limit Check Results**

The following commands are required to query the results of the limit checks.

Useful commands for retrieving results described elsewhere:

- [UNIT:EVM](#) on page 169
- [UNIT:GIMBalance](#) on page 170

**Remote commands exclusive to retrieving limit check results**

<a href="#">CALCulate:LIMit:BURSt:ALL:RESult?</a> .....	170
<a href="#">CALCulate:LIMit:BURSt:EVM:ALL[:AVERage]:RESult?</a> .....	171
<a href="#">CALCulate:LIMit:BURSt:EVM:ALL:MAXimum:RESult?</a> .....	171
<a href="#">CALCulate:LIMit:BURSt:EVM:DATA[:AVERage]:RESult?</a> .....	171
<a href="#">CALCulate:LIMit:BURSt:EVM:DATA:MAXimum:RESult?</a> .....	171
<a href="#">CALCulate:LIMit:BURSt:EVM:PILot[:AVERage]:RESult?</a> .....	171
<a href="#">CALCulate:LIMit:BURSt:EVM:PILot:MAXimum:RESult?</a> .....	171
<a href="#">CALCulate:LIMit:BURSt:FERRor[:AVERage]:RESult?</a> .....	171
<a href="#">CALCulate:LIMit:BURSt:FERRor:MAXimum:RESult?</a> .....	171
<a href="#">CALCulate:LIMit:BURSt:IQOffset[:AVERage]:RESult?</a> .....	172
<a href="#">CALCulate:LIMit:BURSt:IQOffset:MAXimum:RESult?</a> .....	172
<a href="#">CALCulate:LIMit:BURSt:SYMBolerror[:AVERage]:RESult?</a> .....	172
<a href="#">CALCulate:LIMit:BURSt:SYMBolerror:MAXimum:RESult?</a> .....	172

**CALCulate:LIMit:BURSt:ALL:RESult?**

This command returns the result of the EVM limit check for all carriers. The limit value is defined by the standard or the user (see [CALCulate:LIMit:BURSt:ALL](#) on page 145).

**Return values:**

<LimitCheck> **PASS**  
 The defined limit for the parameter was not exceeded.  
**FAILED**  
 The defined limit for the parameter was exceeded.

**Usage:** Query only

---

**CALCulate:LIMit:BURSt:EVM:ALL[:AVERAge]:RESult?**  
**CALCulate:LIMit:BURSt:EVM:ALL:MAXimum:RESult?**

This command returns the result of the average or maximum EVM limit check. The limit value is defined by the standard or the user (see [CALCulate:LIMit:BURSt:EVM:ALL:MAXimum](#) on page 146).

**Return values:**

<LimitCheck>           **PASS**  
 The defined limit for the parameter was not exceeded.

**FAILED**  
 The defined limit for the parameter was exceeded.

**Usage:**                   Query only

---

**CALCulate:LIMit:BURSt:EVM:DATA[:AVERAge]:RESult?**  
**CALCulate:LIMit:BURSt:EVM:DATA:MAXimum:RESult?**

This command returns the result of the average or maximum EVM limit check for data carriers. The limit value is defined by the standard or the user (see [CALCulate:LIMit:BURSt:EVM:DATA:MAXimum](#) on page 146).

**Return values:**

<LimitCheck>           **PASS**  
 The defined limit for the parameter was not exceeded.

**FAILED**  
 The defined limit for the parameter was exceeded.

**Usage:**                   Query only

---

**CALCulate:LIMit:BURSt:EVM:PILot[:AVERAge]:RESult?**  
**CALCulate:LIMit:BURSt:EVM:PILot:MAXimum:RESult?**

This command returns the result of the average or maximum EVM limit check for pilot carriers. The limit value is defined by the standard or the user (see [CALCulate:LIMit:BURSt:EVM:PILot:MAXimum](#) on page 146).

**Return values:**

<LimitCheck>           **PASS**  
 The defined limit for the parameter was not exceeded.

**FAILED**  
 The defined limit for the parameter was exceeded.

**Usage:**                   Query only

---

**CALCulate:LIMit:BURSt:FERRor[:AVERAge]:RESult?**  
**CALCulate:LIMit:BURSt:FERRor:MAXimum:RESult?**

This command returns the result of the average or maximum center frequency error limit check. The limit value is defined by the standard or the user (see [CALCulate:LIMit:BURSt:FERRor:MAXimum](#) on page 147).

**Return values:**

<LimitCheck>      **PASS**  
The defined limit for the parameter was not exceeded.

**FAILED**  
The defined limit for the parameter was exceeded.

**Usage:**                      Query only

**CALCulate:LIMit:BURSt:IQOffset[:AVERage]:RESult?****CALCulate:LIMit:BURSt:IQOffset:MAXimum:RESult?**

This command returns the result of the average or maximum I/Q offset limit check. The limit value is defined by the standard or the user (see [CALCulate:LIMit:BURSt:IQOffset:MAXimum](#) on page 147).

**Return values:**

<LimitCheck>      **PASS**  
The defined limit for the parameter was not exceeded.

**FAILED**  
The defined limit for the parameter was exceeded.

**Usage:**                      Query only

**CALCulate:LIMit:BURSt:SYMBOLerror[:AVERage]:RESult?****CALCulate:LIMit:BURSt:SYMBOLerror:MAXimum:RESult?**

This command returns the result of the average or maximum symbol clock error limit check. The limit value is defined by the standard or the user (see [CALCulate:LIMit:BURSt:SYMBOLerror:MAXimum](#) on page 147).

**Return values:**

<LimitCheck>      **PASS**  
The defined limit for the parameter was not exceeded.

**FAILED**  
The defined limit for the parameter was exceeded.

**Usage:**                      Query only

## 9.8.2 Numeric Results for RF Data

The following commands are required to retrieve the numeric results of the WLAN measurements on RF data (see [chapter 3.2, "Measurements on RF Data"](#), on page 28).



In the following commands used to retrieve the numeric results for RF data, the suffixes <n> for CALCulate and <k> for LIMit are irrelevant.

[CALCulate<n>:LIMit<k>:ACPower:ACHannel:RESult?](#)..... 173

[CALCulate<n>:LIMit<k>:ACPower:ALternate<ch>:RESult?](#)..... 173

CALCulate<n>:LIMit<k>:FAIL.....	173
CALCulate<n>:MARKer<m>:FUNCTion:POWer:RESult?.....	174
CALCulate<n>:STATistics:RESult<t>.....	175

**CALCulate<n>:LIMit<k>:ACPower:ACHannel:RESult?****CALCulate<n>:LIMit<k>:ACPower:ALTErnate<ch>:RESult?**

This command queries the state of the limit check for the adjacent or alternate channels in an ACLR measurement.

To get a valid result, you have to perform a complete measurement with synchronization to the end of the measurement before reading out the result. This is only possible for single sweeps. See also [INITiate:CONTInuous](#) on page 161.

**Return values:**

<LowerChan>,	text value
<UpperChan>	The command returns two results. The first is the result for the lower, the second for the upper adjacent or alternate channel.

**PASSED**

Limit check has passed.

**FAIL**

Limit check has failed.

**Example:**

```
INIT: IMM; *WAI;
CALC: LIM: ACP: ACH: RES?
PASSED, PASSED
```

**Usage:**

Query only

**CALCulate<n>:LIMit<k>:FAIL**

This command queries the result of a limit check.

For measurements in the R&S FSW WLAN application, the numeric suffix <k> specifies the limit line according to [table 9-8](#).

To get a valid result, you have to perform a complete measurement with synchronization to the end of the measurement before reading out the result. This is only possible for single sweeps. See also [INITiate:CONTInuous](#) on page 161.

**Return values:**

<Result>	<b>0</b>
	PASS
	<b>1</b>
	FAIL

**Example:**

```
INIT; *WAI
Starts a new sweep and waits for its end.
CALC: LIM3: FAIL?
Queries the result of the check for limit line 3.
```

**Usage:**

SCPI confirmed

**Manual control:** See ["Spectrum Emission Mask"](#) on page 29

**Table 9-8: Limit line suffix <k> for WLAN application**

Suffix	Limit
1 to 2	These indexes are not used
3	Limit line for Spectrum Emission Mask as defined by ETSI
4	Spectrum Flatness (Upper) limit line
5	Spectrum Flatness (Lower) limit line
6	Limit line for Spectrum Emission Mask as defined by IEEE
7	PVT Rising Edge max limit
8	PVT Rising Edge mean limit
9	PVT Falling Edge max limit
10	PVT Falling Edge mean limit

---

**CALCulate<n>:MARKer<m>:FUNCtion:POWer:RESult? <Measurement>**

This command queries the results of power measurements.

This command is only available for measurements on RF data (see [chapter 3.2, "Measurements on RF Data"](#), on page 28).

To get a valid result, you have to perform a complete measurement with synchronization to the end of the measurement before reading out the result. This is only possible for single sweeps. See also [INITiate:CONTinuous](#) on page 161.

**Query parameters:**

&lt;Measurement&gt;

**ACPower | MCACpower**

ACLR measurements (also known as adjacent channel power or multi-carrier adjacent channel measurements).

Returns the power for every active transmission and adjacent channel. The order is:

- power of the transmission channel
- power of lower adjacent channel
- power of upper adjacent channel
- power of lower alternate channel 1
- power of upper alternate channel 1 (*etc.*)

The unit of the return values depends on the scaling of the y-axis:

- logarithmic scaling returns the power in the current unit
- linear scaling returns the power in W

**CN**

Carrier-to-noise measurements.

Returns the C/N ratio in dB.

**CNO**

Carrier-to-noise measurements.

Returns the C/N ratio referenced to a 1 Hz bandwidth in dBm/Hz.

**CPOWer**

Channel power measurements.

Returns the channel power. The unit of the return values depends on the scaling of the y-axis:

- logarithmic scaling returns the power in the current unit
- linear scaling returns the power in W

For SEM measurements, the return value is the channel power of the reference range.

**PPOWer**

Peak power measurements.

Returns the peak power. The unit of the return values depends on the scaling of the y-axis:

- logarithmic scaling returns the power in the current unit
- linear scaling returns the power in W

For SEM measurements, the return value is the peak power of the reference range.

**OBANdwidth | OBWidth**

Occupied bandwidth.

Returns the occupied bandwidth in Hz.

**Manual control:**

See "[Channel Power ACLR](#)" on page 29

See "[Occupied Bandwidth](#)" on page 30

**CALCulate<n>:STATistics:RESult<t> <ResultType>**

This command queries the results of a CCDF or ADP measurement.

**Parameters:**

&lt;ResultType&gt;

**MEAN**

Average (=RMS) power in dBm measured during the measurement time.

**PEAK**

Peak power in dBm measured during the measurement time.

**CFACTOR**

Determined crest factor (= ratio of peak power to average power) in dB.

**ALL**

Results of all three measurements mentioned before, separated by commas: &lt;mean power&gt;,&lt;peak power&gt;,&lt;crest factor&gt;

**Example:**`CALC:STAT:RES2? ALL`

Reads out the three measurement results of trace 2. Example of answer string: 5.56,19.25,13.69 i.e. mean power: 5.56 dBm, peak power 19.25 dBm, crest factor 13.69 dB

**Manual control:**See "[CCDF](#)" on page 31

### 9.8.3 Retrieving Trace Results

The following commands describe how to retrieve the trace data from the default WLAN measurement (Modulation Accuracy, Flatness and Tolerance). Note that for these measurements, only 1 trace per window can be configured.

The traces for measurements on RF data are identical to those in the Spectrum application.

**FORMat[:DATA] <Format>**

This command selects the data format that is used for transmission of trace data from the R&S FSW to the controlling computer.

Note that the command has no effect for data that you send to the R&S FSW. The R&S FSW automatically recognizes the data it receives, regardless of the format.



**Parameters:**

&lt;Format&gt;

**AScii**

AScii format, separated by commas.

This format is almost always suitable, regardless of the actual data format. However, the data is not as compact as other formats may be.

**REAL,32**

32-bit IEEE 754 floating-point numbers in the "definite length block format".

In the Spectrum application, the format setting `REAL` is used for the binary transmission of trace data.

**UINT**

In the R&S FSW WLAN application, bitstream data can be sent as unsigned integers format to improve the data transfer speed (compared to ASCII format).

\*RST:        ASCII

**Example:**

```
FORM REAL,32
```

**Usage:**

SCPI confirmed

**TRACe<n>[:DATA] <ResultType>**

This command queries current trace data and measurement results from the selected window.

For details see [chapter 9.8.4, "Measurement Results for TRACe<n>\[:DATA\]? TRACE<n>"](#), on page 179.

**Parameters:**

&lt;ResultType&gt;

Selects the type of result to be returned.

**TRACE1 | ... | TRACE6**

Returns the trace data for the corresponding trace.

Note that for the default WLAN I/Q measurement (Modulation Accuracy, Flatness and Tolerance), only 1 trace per window (TRACE1) is available.

**LIST**

Returns the results of the peak list evaluation for Spectrum Emission Mask measurements.

**Return values:**

&lt;TraceData&gt;

For more information see tables below.

**Example:**

```
TRAC? TRACE3
```

Queries the data of trace 3.

**Manual control:**

See "[Spectrum Emission Mask](#)" on page 29

**Table 9-9: Return values for TRACE1 to TRACE6 parameter**

For I/Q data traces, the results depend on the evaluation method (window type) selected for the current window (see [LAYout : ADD \[ : WINDow \] ?](#) on page 152. The results for the various window types are described in [chapter 9.8.4, "Measurement Results for TRACe<n>\[:DATA\]? TRACE<n>"](#), on page 179.

For RF data traces, the trace data consists of a list of 1001 power levels that have been measured. The unit depends on the measurement and on the unit you have currently set.

For SEM measurements, the x-values should be queried as well, as they are not equi-distant (see [TRACe<n> \[ : DATA \] : X?](#) on page 178).

**Table 9-10: Return values for LIST parameter**

This parameter is only available for SEM measurements.

For each sweep list range you have defined (range 1...n), the command returns eight values in the following order.

<No>, <StartFreq>, <StopFreq>, <RBW>, <PeakFreq>, <PowerAbs>, <PowerRel>, <PowerDelta>, <LimitCheck>, <Unused1>, <Unused2>

- <No>: range number
- <StartFreq>, <StopFreq>: start and stop frequency of the range
- <RBW>: resolution bandwidth
- <PeakFreq>: frequency of the peak in a range
- <PowerAbs>: absolute power of the peak in dBm
- <PowerRel>: power of the peak in relation to the channel power in dBc
- <PowerDelta>: distance from the peak to the limit line in dB, positive values indicate a failed limit check
- <LimitCheck>: state of the limit check (0 = PASS, 1 = FAIL)
- <Unused1>, <Unused2>: reserved (0.0)

### TRACe<n>[:DATA]:X? <TraceNumber>

This command queries the horizontal trace data. This is especially useful for traces with non-equidistant x-values, e.g. for SEM or Spurious Emissions measurements.

#### Query parameters:

<TraceNumber> Trace number.

**TRACE1 | ... | TRACE6**

#### Example:

TRAC:X? TRAC1

Returns the x-values for trace 1.

#### Usage:

Query only

### TRACe:IQ:DATA:MEMory <OffsetSamp>, <NumSamples>

Returns all the I/Q trace data in the capture buffer. The result values are scaled in Volts. The command returns a comma-separated list of the measured voltage values in floating point format (Comma Separated Values = CSV). The number of values returned is 2 \* the number of complex samples, the first half being the I values, the second half the Q values.

The total number of complex samples is displayed in the channel bar in manual operation and can be calculated as:

<SampleRate> \* <CaptureTime>

(See [TRACe:IQ:SRATe](#) on page 122 and [\[SENSe:\]SWEep:TIME](#) on page 122)

**Parameters:**

<OffsetSamp>	Offset of the values to be read related to the start of the capture buffer. Range: 0 to (<NumSamples>-1)
<NumSamples>	Number of measurement values to be read. Range: 1 to (<NumSamples>-<OffsetSa>) *RST: RST value

**9.8.4 Measurement Results for TRACe<n>[:DATA]? TRACE<n>**

The evaluation method selected by the `LAY:ADD:WIND` command also affects the results of the trace data query (see [TRACe<n>\[:DATA\]? TRACE<n>](#)).

Details on the returned trace data depending on the evaluation method are provided here.



No trace data is available for the following evaluation methods:

- Magnitude Capture
  - Result Summary (Global/Detailed)
- 

For details on the graphical results of these evaluation methods, see [chapter 3.1.2, "Evaluation Methods for Default WLAN Measurements"](#), on page 16.

The following table provides an overview of the main characteristics of the WLAN OFDM symbol structure in the frequency domain for various standards. The description of the TRACe results refers to these values to simplify the description.

Table 9-11: WLAN OFDM symbol structure in the frequency domain

Standard	CBW / MHz	$N_{FFT}$	$N_{SD}$ No. of data sc	$N_{SP}$ No. of pilot sc	Pilot subcarrier (sc)	$N_{ST}$ No. of sc total : $=N_{SD}+N_{SP}$	$N_{Null}$ No. of DC/ Null sc	DC / Null subcarrier	$N_{Used}$ No. of used sc : $=N_{ST}+N_{Null}$	$N_{guard} := N_{FT} - N_{Used}$	Comment
11a	5	64	48	4	{-21,-7,7,21}	52	1	{0}	53	11	IEEE Std 802.11-2012 Tab Table 18-5—Timing-related parameters
	10	64	48	4	{-21,-7,7,21}	52	1	{0}	53	11	IEEE Std 802.11-2012 Tab Table 18-5—Timing-related parameters
	20	64	48	4	{-21,-7,7,21}	52	1	{0}	53	11	IEEE Std 802.11-2012 Tab Table 18-5—Timing-related parameters
11n	20	64	52	4	{-21,-7,7,21}¹)	56	1	{0}	57	7	IEEE Std 802.11-2012 Tab Table 20-6—Timing-related constants
	40	128	108	6	{-53, -25, -11, 11, 25, 53}¹)	114	3	{-1,0,1}³)	117	11	IEEE Std 802.11-2012 Tab Table 20-6—Timing-related constants
11ac	20	64	52	4	{-21,-7,7,21}²)	56	1	{0}	57	7	IEEE P802.11ac/D2.1, March 2012 Table 22-5—Timing-related constants
	40	128	108	6	{-53, -25, -11, 11, 25, 53}²)	114	3	{-1,0,1}⁴)	117	11	IEEE P802.11ac/D2.1, March 2012 Table 22-5—Timing-related constants

1) IEEE Std 802.11-2012 Section 20.3.11.10 Pilot subcarriers  
2) IEEE P802.11ac/D2.1, March 2012 Section 22.3.10.10 Pilot subcarriers  
3) IEEE Std 802.11-2012 equation (20-59)  
4) IEEE P802.11ac/D2.1, March 2012 equation (22-94)  
5) IEEE P802.11ac/D2.1, March 2012 equation (22-95)  
6) IEEE P802.11ac/D2.1, March 2012 equation (22-96)

Standard	CBW / MHz	N <sub>FFT</sub>	N <sub>SD</sub> No. of data sc	N <sub>SP</sub> No. of pilot sc	Pilot subcarrier (sc)	N <sub>ST</sub> No. of sc total : =N <sub>SD</sub> +N <sub>SP</sub>	N <sub>Null</sub> No. of DC/ Null sc	DC / Null subcarrier	N <sub>Used</sub> No. of used sc := N <sub>ST</sub> + N <sub>Null</sub>	N <sub>guard</sub> := N <sub>F</sub> - N <sub>Used</sub>	Comment
	80	256	234	8	{-103, -75, -39, -11, 11, 39, 75, 103} <sup>2)</sup>	242	3	{-1, 0, 1} <sup>5)</sup>	245	11	IEEE P802.11ac/D2.1, March 2012 Table 22-5—Timing-related constants
	160	512	468	16	{-231, -203, -167, -139, -117, -89, -53, -25, 25, 53, 89, 117, 139, 167, 203, 231} <sup>2)</sup>	484	17	{-129, -128, -127, -5:1:5, 127, 128, 129} <sup>6)</sup>	501	11	IEEE P802.11ac/D2.1, March 2012 Table 22-5—Timing-related constants

1) IEEE Std 802.11-2012 Section 20.3.11.10 Pilot subcarriers  
 2) IEEE P802.11ac/D2.1, March 2012 Section 22.3.10.10 Pilot subcarriers  
 3) IEEE Std 802.11-2012 equation (20-59)  
 4) IEEE P802.11ac/D2.1, March 2012 equation (22-94)  
 5) IEEE P802.11ac/D2.1, March 2012 equation (22-95)  
 6) IEEE P802.11ac/D2.1, March 2012 equation (22-96)

• Bitstream.....	182
• CCDF – Complementary Cumulative Distribution Function.....	182
• Constellation.....	182
• Constellation vs Carrier.....	183
• EVM vs Carrier.....	184
• FFT Spectrum.....	184
• Group Delay.....	184
• Power vs Time Full Burst.....	185
• Signal Field.....	185
• Spectrum Flatness.....	185

#### 9.8.4.1 Bitstream

Data is returned depending on the selected standard for which the measurement was executed (see `CONFigure:STANdard` on page 112):

- For the IEEE 802.11a and n standard, data is returned in repeating groups of 52 data channels (or 56 channels within the n standard) where each symbol value is represented by an integer value within one byte. Channel 0 is unused and therefore does not have any data associated with it, with no return data being provided.

Supported data formats: `ASCIi|UINT` (see `FORMat[:DATA]` on page 176)

#### 9.8.4.2 CCDF – Complementary Cumulative Distribution Function

The length of the results varies; up to a maximum of 201 data points is returned, following a data count value. The first value in the return data represents the quantity of probability values that follow. Each of the potential 201 data points is returned as a probability value and represents the total number of samples that are equal to or exceed the current mean power level.

Probability data is returned up to the power level that contains at least one sample. It is highly unlikely that the full 201 data values will ever be returned.

Each probability value is returned as a floating point number, with a value between 0 and 1.

The syntax of the result is thus:

`N, CCDF(0), CCDF(1/10), CCDF(2/10), ..., CCDF((N-1)/10)`

#### 9.8.4.3 Constellation

This measurement represents the complex constellation points as I and Q data. See for example IEEE Std. 802.11-2012 'Fig. 18-10 BPSK, QPSK, 16-QAM and 64-QAM constellation bit encoding'. Each I and Q point is returned in floating point format.

Data is returned as a repeating array of interleaved I and Q data in groups of selected carriers per OFDM-Symbol, until all the I and Q data for the analyzed OFDM-Symbols is exhausted.

The following carrier selections are possible:

- "All Carriers": `CONFigure:BURSt:CONStellation:CARRier:SElect ALL`  
 $N_{ST}$  pairs of I and Q data per OFDM-Symbol  
 OFDM-Symbol 1:  $(I_{1,1}, Q_{1,1}), (I_{1,2}, Q_{1,2}), \dots, (I_{1,Nst}, Q_{1,Nst})$   
 OFDM-Symbol 2:  $(I_{2,1}, Q_{2,1}), (I_{2,2}, Q_{2,2}), \dots, (I_{2,Nst}, Q_{2,Nst})$   
 ...  
 OFDM-Symbol N:  
 $(I_{N,1}, Q_{N,1}), (I_{N,2}, Q_{N,2}), \dots, (I_{N,Nst}, Q_{N,Nst})$
- "Pilots Only": `CONFigure:BURSt:CONStellation:CARRier:SElect PILOTS`  
 $N_{SP}$  pairs of I and Q data per OFDM-Symbol in the natural number order.  
 OFDM-Symbol 1:  $(I_{1,1}, Q_{1,1}), (I_{1,2}, Q_{1,2}), \dots, (I_{1,Nsp}, Q_{1,Nsp})$   
 OFDM-Symbol 2:  $(I_{2,1}, Q_{2,1}), (I_{2,2}, Q_{2,2}), \dots, (I_{2,Nsp}, Q_{2,Nsp})$   
 ...  
 OFDM-Symbol N:  
 $(I_{N,1}, Q_{N,1}), (I_{N,2}, Q_{N,2}), \dots, (I_{N,Nsp}, Q_{N,Nsp})$
- Single carrier:  
 1 pair of I and Q data per OFDM-Symbol for the selected carrier  
`CONFigure:BURSt:CONStellation:CARRier:SElect k`  
 with  
 $k \in \left\{ -\frac{(N_{used} - 1)}{2}, -\frac{(N_{used} - 1)}{2} + 1, \dots, \frac{(N_{used} - 1)}{2} \right\}$   
 OFDM-Symbol 1:  $(I_{1,1}, Q_{1,1})$   
 OFDM-Symbol 2:  $(I_{2,1}, Q_{2,1})$   
 ...  
 OFDM-Symbol N:  $(I_{N,1}, Q_{N,1})$

#### 9.8.4.4 Constellation vs Carrier

This measurement represents the complex constellation points as I and Q data. See for example IEEE Std. 802.11-2012 'Fig. 18-10 BPSK, QPSK, 16-QAM and 64-QAM constellation bit encoding'. Each I and Q point is returned in floating point format. Data is returned as a repeating array of interleaved I and Q data in groups of  $N_{used}$  subcarriers per OFDM-Symbol, until all the I and Q data for the analyzed OFDM-Symbols is exhausted.

Note that as opposed to the Constellation results, the DC/null subcarriers are included as NaNs.

$N_{used}$  pairs of I and Q data per OFDM-Symbol

OFDM-Symbol 1:  $(I_{1,1}, Q_{1,1}), (I_{1,2}, Q_{1,2}), \dots, (I_{1,Nused}, Q_{1,Nused})$

OFDM-Symbol 2:  $(I_{2,1}, Q_{2,1}), (I_{2,2}, Q_{2,2}), \dots, (I_{2,Nused}, Q_{2,Nused})$

...

OFDM-Symbol N:

$(I_{N,1}, Q_{N,1}), (I_{N,2}, Q_{N,2}), \dots, (I_{N,Nused}, Q_{N,Nused})$

### 9.8.4.5 EVM vs Carrier

Three trace types are provided for this evaluation:

**Table 9-12: Query parameter and results for EVM vs Carrier**

TRACE1	The minimum EVM value - over the analyzed PPDU's - for each of the $N_{used}$ subcarriers
TRACE2	The average EVM value - over the analyzed PPDU's - for each of the $N_{used}$ subcarriers
TRACE3	The maximum EVM value - over the analyzed PPDU's - for each of the $N_{used}$ subcarriers

Each EVM value is returned as a floating point number, expressed in units of dB.

Supported data formats (see [FORMat \[:DATA\]](#) on page 176): ASCii|UINT

**Example:**

For  $EVM_{m,n}$ : the EVM of the m-th analyzed PDU for the subcarrier  $n = \{1, 2, \dots, N_{used}\}$

TRACE1: Minimum EVM value per subcarrier

Minimum( $EVM_{1,1}$ ,  $EVM_{2,1}$ , ...,  $EVM_{Statistic\ Length,1}$ ),

// Minimum EVM value for subcarrier  $-(N_{used}-1)/2$

Minimum( $EVM_{1,2}$ ,  $EVM_{2,2}$ , ...,  $EVM_{Statistic\ Length,2}$ ),

// Minimum EVM value for subcarrier  $-(N_{used}-1)/2 + 1$

...

Minimum( $EVM_{1,N_{used}}$ ,  $EVM_{2,N_{used}}$ , ...,  $EVM_{Statistic\ Length,N_{used}}$ )

// Minimum EVM value for subcarrier  $+(N_{used}-1)/2$

### 9.8.4.6 FFT Spectrum

Returns the power vs frequency values obtained from the FFT. This is an exhaustive call, due to the fact that there are nearly always more FFT points than I/Q samples. The number of FFT points is a power of 2 that is higher than the total number of I/Q samples, i.e.: number of FFT points := round number of I/Q-samples to next power of 2.

E.g. if there were 20000 samples, then 32768 FFT points are returned.

Data is returned in floating point format in dBm.

### 9.8.4.7 Group Delay

Currently the following trace types are provided with this measurement:

- TRACE1  
A repeating list of group delay values for each subcarrier. The number of repeating lists corresponds to the number of fully analyzed PPDU's as displayed in the current Magnitude Capture. Each group delay value is returned as a floating point number, expressed in units of seconds.
- TRACE  
All group delay values per subcarrier for each analyzed PDU of the capture period



**Example:**

For  $GD_{m,n}$ : the group delay of the m-th analyzed PPDU for the subcarrier corresponding to  $n = \{1, 2, \dots, N_{used}\}$ ;

```
TRACE:DATA? TRACE2
```

Analyzed PPDU 1:

$GD_{1,1}, GD_{1,2}, \dots,$

Analyzed PPDU 2:

$GD_{2,1}, GD_{2,2}, \dots,$

...

Analyzed PPDU N :

$GD_{N,1}, GD_{N,2}, \dots,$

**9.8.4.8 Power vs Time Full Burst**

All complete PDUs within the capture time are analyzed in three master PDUs. The three master PDUs relate to the minimum, maximum and average values across all complete PDUs. This data is returned in dBm values on a per sample basis. Each sample relates to an analysis of each corresponding sample within each processed PDU.

The type of PVT data returned is determined by the TRACE number passed as an argument to the SCPI command:

TRACE1	minimum PDU data values
TRACE2	mean PDU data values
TRACE3	maximum PDU data values

Supported data formats (see [FORMat \[:DATA\]](#) on page 176): ASCii|REAL

**9.8.4.9 Signal Field**

The bits are returned as read from the corresponding signal field parts in transmit order. I.e. the first transmitted bit has the highest significance and the last transmitted bit has the lowest significance. See also "Signal Field" on page 24.

The `TRAC:DATA?` command returns the information as read from the signal field for each analyzed PDU. The signal field bit sequence is converted to an equivalent sequence of hexadecimal digits for each analyzed PDU in transmit order.

**9.8.4.10 Spectrum Flatness**

The spectrum flatness evaluation returns absolute power values per carrier.

Two trace types are provided for this evaluation:

**Table 9-13: Query parameter and results for Spectrum Flatness**

TRACE1	All spectrum flatness values per channel
TRACE2	An average spectrum flatness value for each of the 53 (or 57/117 within the IEEE 802.11 n standard) carriers

Absolute power results are returned in dB.

Supported data formats (FORMAT:DATA): ASCii|REAL

### 9.8.5 Importing and Exporting I/Q Data and Results

The I/Q data to be evaluated in the WLAN application can not only be measured by the WLAN application itself, it can also be imported to the application, provided it has the correct format. Furthermore, the evaluated I/Q data from the WLAN application can be exported for further analysis in external applications.

For details on importing and exporting I/Q data see the R&S FSW User Manual.

<a href="#">MMEMory:LOAD:IQ:STATe.....</a>	186
<a href="#">MMEMory:STORe:IQ:STATe.....</a>	186

---

#### **MMEMory:LOAD:IQ:STATe 1,<FileName>**

This command restores I/Q data from a file.

The file extension is \*.iqw.

#### **Parameters:**

1

<FileName> String containing the path and name of the source file.

#### **Example:**

```
MMEM:LOAD:IQ:STAT 1, 'C:
\R_S\Instr\user\data.iqw'
Loads IQ data from the specified file.
```

#### **Usage:**

Setting only

#### **Manual control:**

See "Import" on page 88  
See "IQ Import" on page 88

---

#### **MMEMory:STORe:IQ:STATe 1, <FileName>**

This command writes the captured I/Q data to a file.

The file extension is \*.iq.tar. By default, the contents of the file are in 32-bit floating point format.

#### **Parameters:**

1

<FileName> String containing the path and name of the target file.

**Example:** `MMEM:STOR:IQ:STAT 1, 'C:\R_S\Instr\user\data.iq.tar'`  
Stores the captured I/Q data to the specified file.

**Manual control:** See "Export" on page 88  
See "IQ Export" on page 88

## 9.9 Analysis

The following commands define general result analysis settings concerning the traces and markers in standard WLAN measurements. Currently, only one (Clear/Write) trace and one marker are available for standard WLAN measurements.



### Analysis for RF measurements

General result analysis settings concerning the trace, markers, lines etc. are identical to the analysis functions in the Spectrum application except for some special marker functions and spectrograms, which are not available in the WLAN application.

For details see the "General Measurement Analysis and Display" chapter in the R&S FSW User Manual.

- [Markers](#).....187
- [Zooming into the Display](#).....188

### 9.9.1 Markers

Markers help you analyze your measurement results by determining particular values in the diagram. Currently, only 1 marker per window can be configured for standard WLAN measurements.

- [CALCulate<n>:MARKer<m>\[:STATe\]](#).....187
- [CALCulate<n>:MARKer<m>:Y?](#).....187

#### **CALCulate<n>:MARKer<m>[:STATe]** <State>

This command turns markers on and off. If the corresponding marker number is currently active as a deltamarker, it is turned into a normal marker.

#### **Parameters:**

<State>                   ON | OFF  
\*RST:                   OFF

**Example:**               CALC:MARK3 ON  
Switches on marker 3.

#### **CALCulate<n>:MARKer<m>:Y?**

This command queries the position of a marker on the y-axis.

If necessary, the command activates the marker first.

To get a valid result, you have to perform a complete measurement with synchronization to the end of the measurement before reading out the result. This is only possible for single sweeps. See also `INITiate:CONTinuous` on page 161.

**Return values:**

<Result> Result at the marker position.

**Example:**

```
INIT:CONT OFF
Switches to single measurement mode.
CALC:MARK2 ON
Switches marker 2.
INIT;*WAI
Starts a measurement and waits for the end.
CALC:MARK2:Y?
Outputs the measured value of marker 2.
```

**Usage:** Query only

**Manual control:** See "CCDF" on page 31

## 9.9.2 Zooming into the Display

### 9.9.2.1 Using the Single Zoom

<code>DISPlay[:WINDow&lt;n&gt;]:ZOOM:AREA</code> .....	188
<code>DISPlay[:WINDow&lt;n&gt;]:ZOOM:STATE</code> .....	189

**DISPlay[:WINDow<n>]:ZOOM:AREA <x1>,<y1>,<x2>,<y2>**

This command defines the zoom area.

To define a zoom area, you first have to turn the zoom on.

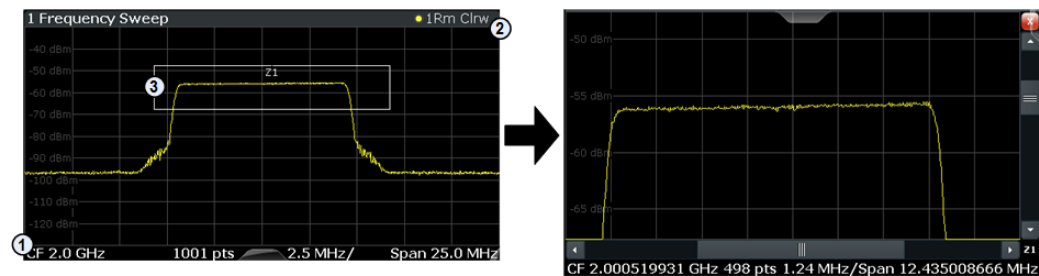

- 1 = origin of coordinate system (x1 = 0, y1 = 0)
- 2 = end point of system (x2 = 100, y2 = 100)
- 3 = zoom area (e.g. x1 = 60, y1 = 30, x2 = 80, y2 = 75)

**Parameters:**

<x1>,<y1>,  
<x2>,<y2>

Diagram coordinates in % of the complete diagram that define the zoom area.  
The lower left corner is the origin of coordinate system. The upper right corner is the end point of the system.  
Range: 0 to 100  
Default unit: PCT

**DISPlay[:WINDow<n>]:ZOOM:STATE <State>**

This command turns the zoom on and off.

**Parameters:**

<State> ON | OFF  
\*RST: OFF

**Example:**

DISP:ZOOM ON  
Activates the zoom mode.

**9.9.2.2 Using the Multiple Zoom**

DISPlay[:WINDow<n>]:ZOOM:MULTiple<zoom>:AREA..... 189  
DISPlay[:WINDow<n>]:ZOOM:MULTiple<zoom>:STATE..... 190

**DISPlay[:WINDow<n>]:ZOOM:MULTiple<zoom>:AREA <x1>,<y1>,<x2>,<y2>**

This command defines the zoom area for a multiple zoom.

To define a zoom area, you first have to turn the zoom on.

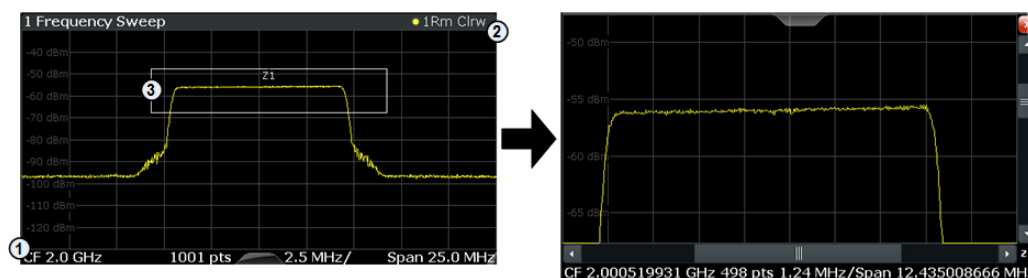

- 1 = origin of coordinate system (x1 = 0, y1 = 0)
- 2 = end point of system (x2 = 100, y2 = 100)
- 3 = zoom area (e.g. x1 = 60, y1 = 30, x2 = 80, y2 = 75)

**Suffix:**

<zoom> 1...4  
Selects the zoom window.

**Parameters:**

<x1>,<y1>,  
<x2>,<y2>

Diagram coordinates in % of the complete diagram that define the zoom area.

The lower left corner is the origin of coordinate system. The upper right corner is the end point of the system.

Range: 0 to 100

Default unit: PCT

**DISPlay[:WINDow<n>]:ZOOM:MULTiple<zoom>:STATe <State>**

This command turns the multiple zoom on and off.

**Suffix:**

<zoom>

1...4

Selects the zoom window.

If you turn off one of the zoom windows, all subsequent zoom windows move up one position.

**Parameters:**

<State>

ON | OFF

\*RST: OFF

## 9.10 Status Registers

The WLAN application uses the standard status registers of the R&S FSW (depending on the measurement type). However, some registers are used differently. Only those differences are described in the following sections.

For details on the common R&S FSW status registers refer to the description of remote control basics in the R&S FSW User Manual.



\*RST does not influence the status registers.

- [The STATus:QUEStionable:SYNC Register](#)..... 190
- [Querying the Status Registers](#)..... 191

### 9.10.1 The STATus:QUEStionable:SYNC Register

The STATus:QUEStionable:SYNC register contains application-specific information about synchronization errors or errors during pilot symbol detection. If any errors occur in this register, the status bit #11 in the STATus:QUEStionable register is set to 1.



Each active channel uses a separate `STATUS:QUESTIONABLE:SYNC` register. Thus, if the status bit #11 in the `STATUS:QUESTIONABLE` register indicates an error, the error may have occurred in any of the channel-specific `STATUS:QUESTIONABLE:SYNC` registers. In this case, you must check the register of each channel to determine which channel caused the error. By default, querying the status of a register always returns the result for the currently selected channel. However, you can specify any other channel name as a query parameter.

**Table 9-14: Meaning of the bits used in the `STATUS:QUESTIONABLE:SYNC` register**

Bit No.	Meaning
0	BURSt not found This bit is set if an IQ measurement is performed and no bursts are detected
1	This bit is not used
2	No bursts of REQuired type This bit is set if an IQ measurement is performed and no bursts of the specified type are detected
3	GATE length too small This bit is set if gating is used in a measurement and the gate length is not set sufficiently large enough
4	BURSt count too small This bit is set if a PVT measurement is performed with gating active and there is not at least 1 burst within the gate lines
5	Auto level OVERload This bit is set if a signal overload is detected when an auto-level measurement is performed
6	Auto level NoSIGnal This bit is set if no signal is detected by the auto-level measurement
7 - 14	These bits are not used.
15	This bit is always 0.

## 9.10.2 Querying the Status Registers

The following commands are required to query the status of the R&S FSW and the WLAN application.

For more information on the contents of the status registers see:

- [chapter 9.10.1, "The STATUS:QUESTIONABLE:SYNC Register"](#), on page 190
- [General Status Register Commands](#)..... 192
- [Reading Out the EVENT Part](#)..... 192
- [Reading Out the CONDition Part](#)..... 192
- [Controlling the ENABLE Part](#)..... 193
- [Controlling the Negative Transition Part](#)..... 193
- [Controlling the Positive Transition Part](#)..... 194

### 9.10.2.1 General Status Register Commands

STATus:PRESet.....	192
STATus:QUEue[:NEXT?]?.....	192

---

#### STATus:PRESet

This command resets the edge detectors and ENABLE parts of all registers to a defined value. All PTRansition parts are set to FFFFh, i.e. all transitions from 0 to 1 are detected. All NTRansition parts are set to 0, i.e. a transition from 1 to 0 in a CONDition bit is not detected. The ENABLE part of the STATus:OPERation and STATus:QUESTionable registers are set to 0, i.e. all events in these registers are not passed on.

**Usage:**                      Event

---

#### STATus:QUEue[:NEXT?]?

This command queries the most recent error queue entry and deletes it.

Positive error numbers indicate device-specific errors, negative error numbers are error messages defined by SCPI. If the error queue is empty, the error number 0, "No error", is returned.

**Usage:**                      Query only

### 9.10.2.2 Reading Out the EVENT Part

---

#### STATus:OPERation[:EVENT]?

#### STATus:QUESTionable[:EVENT]?

#### STATus:QUESTionable:ACPLimit[:EVENT]? <ChannelName>

#### STATus:QUESTionable:LIMit<n>[:EVENT]? <ChannelName>

#### STATus:QUESTionable:SYNC[:EVENT]? <ChannelName>

This command reads out the EVENT section of the status register.

The command also deletes the contents of the EVENT section.

#### Query parameters:

<ChannelName>              String containing the name of the channel.  
The parameter is optional. If you omit it, the command works for the currently active channel.

**Usage:**                      Query only

### 9.10.2.3 Reading Out the CONDition Part

---

#### STATus:OPERation:CONDition?

#### STATus:QUESTionable:CONDition?

#### STATus:QUESTionable:ACPLimit:CONDition? <ChannelName>



**STATus:QUESTionable:LIMit<n>:CONDition?** <ChannelName>  
**STATus:QUESTionable:SYNC:CONDition?** <ChannelName>

This command reads out the CONDition section of the status register.

The command does not delete the contents of the EVENT section.

**Query parameters:**

<ChannelName> String containing the name of the channel.  
 The parameter is optional. If you omit it, the command works for the currently active channel.

**Usage:** Query only

#### 9.10.2.4 Controlling the ENABLE Part

---

**STATus:OPERation:ENABLE** <SumBit>  
**STATus:QUESTionable:ENABLE** <SumBit>  
**STATus:QUESTionable:ACPLimit:ENABLE** <SumBit>,<ChannelName>  
**STATus:QUESTionable:LIMit<n>:ENABLE** <SumBit>,<ChannelName>  
**STATus:QUESTionable:SYNC:ENABLE** <SumBit>,<ChannelName>

This command controls the ENABLE part of a register.

The ENABLE part allows true conditions in the EVENT part of the status register to be reported in the summary bit. If a bit is 1 in the enable register and its associated event bit transitions to true, a positive transition will occur in the summary bit reported to the next higher level.

**Parameters:**

<SumBit> Range: 0 to 65535  
 <ChannelName> String containing the name of the channel.  
 The parameter is optional. If you omit it, the command works for the currently active channel.

#### 9.10.2.5 Controlling the Negative Transition Part

---

**STATus:OPERation:NTRansition** <SumBit>  
**STATus:QUESTionable:NTRansition** <SumBit>  
**STATus:QUESTionable:ACPLimit:NTRansition** <SumBit>,<ChannelName>  
**STATus:QUESTionable:LIMit<n>:NTRansition** <SumBit>,<ChannelName>  
**STATus:QUESTionable:SYNC:NTRansition** <SumBit>,<ChannelName>

This command controls the Negative TRansition part of a register.

Setting a bit causes a 1 to 0 transition in the corresponding bit of the associated register. The transition also writes a 1 into the associated bit of the corresponding EVENT register.

**Parameters:**

<SumBit> Range: 0 to 65535

<ChannelName> String containing the name of the channel.  
The parameter is optional. If you omit it, the command works for the currently active channel.

### 9.10.2.6 Controlling the Positive Transition Part

**STATus:OPERation:PTRansition** <SumBit>  
**STATus:QUESTionable:PTRansition** <SumBit>  
**STATus:QUESTionable:ACPLimit:PTRansition** <SumBit>,<ChannelName>  
**STATus:QUESTionable:LIMit<n>:PTRansition** <SumBit>,<ChannelName>  
**STATus:QUESTionable:SYNC:PTRansition** <SumBit>,<ChannelName>

These commands control the Positive TRansition part of a register.

Setting a bit causes a 0 to 1 transition in the corresponding bit of the associated register. The transition also writes a 1 into the associated bit of the corresponding EVENT register.

**Parameters:**

<SumBit> Range: 0 to 65535  
 <ChannelName> String containing the name of the channel.  
 The parameter is optional. If you omit it, the command works for the currently active channel.

## 9.11 Commands for Compatibility

The following commands are provided only for compatibility to remote control programs from WLAN applications on previous signal analyzers. For new remote control programs use the specified alternative commands.



The **CONF:BURS:<ResultType>:IMM** commands used in former R&S Signal and Spectrum Analyzers to change the result display are still supported for compatibility reasons; however they have been replaced by the **LAY:ADD:WIND** commands in the R&S FSW (see [chapter 9.6, "Configuring the Result Display"](#), on page 150). Note that the **CONF:BURS:<ResultType>:IMM** commands change the screen layout to display the Magnitude Capture buffer in window 1 at the top of the screen and the selected result type in window 2 below that.

**MMEMemory:LOAD:SEM:STATe**..... 194  
**[SENSe:]DEMod:FORMat:BANalyze:BTYPe**..... 195  
**TRIGger[SEquence]:MODE**..... 195

**MMEMemory:LOAD:SEM:STATe** <1>, <Filename>

This command loads a spectrum emission mask setup from an xml file.

Note that this command is maintained for compatibility reasons only. Use the **SENS:ESP:PRES** command for new remote control programs.

See the R&S FSW User Manual, "Remote commands for SEM measurements" chapter.

**Parameters:**

<1>

<Filename> string  
Path and name of the .xml file that contains the SEM setup information.

**Example:**

```
MMEM:LOAD:SEM:STAT 1,
'..\sem_std\WLAN\802_11a\802_11a_10MHz_5GHz_band.XML'
```

**[SENSe:]DEMod:FORMat:BANalyze:BTYPe <PPDUType>**

This remote control command specifies the type of PPDU to be analyzed. Only PPDUs of the specified type take part in measurement analysis.

Note that this command is maintained for compatibility reasons only. Use the specified commands for new remote control programs (see [\[SENSe:\]DEMod:FORMat:BANalyze:BTYPe:AUTO:TYPE](#) on page 138 and [\[SENSe:\]BANDwidth:CHANnel:AUTO:TYPE](#) on page 136).

**Parameters:**

<PPDUType> **'MM20'**  
IEEE 802.11n, Mixed Mode, 20 MHz sampling rate  
For new programs use:  
`[SENSe:]DEMod:FORMat:BANalyze:BTYPe:AUTO:TYPE`  
MMIX  
`[SENSe:]BANDwidth:CHANnel:AUTO:TYPE` MB20

**'GFM20'**  
IEEE 802.11n Green Field Mode, 20 MHz sampling rate  
For new programs use:  
`[SENSe:]DEMod:FORMat:BANalyze:BTYPe:AUTO:TYPE`  
MGRF  
`[SENSe:]BANDwidth:CHANnel:AUTO:TYPE` MB20

**TRIGger[:SEQuence]:MODE <Source>**

Defines the trigger source.

Note that this command is maintained for compatibility reasons only. Use the [TRIGger\[:SEQuence\]:SOURce](#) on page 126 commands for new remote control programs.

This command configures how triggering is to be performed.

**Parameters:**

<Source> IMMEDIATE | EXTERNAL | VIDEO | RFPower | IFPower | TV | AF | AM | FM | PM | AMRelative | LXI | TIME | SLEFt | SRIGHt | SMPX | SMONo | SSTereo | SRDS | SPILot | BBPower | MASK | PSEnSor | TDTRigger | IQPower | EXT2 | EXT3

## 9.12 Programming Examples (R&S FSW-K91)

This example demonstrates how to configure an EVM measurement in a remote environment.

- [Measurement 1: Measuring Modulation Accuracy for WLAN 802.11n Standard](#) .....196
- [Measurement 2: Determining the Spectrum Emission Mask](#).....199

### 9.12.1 Measurement 1: Measuring Modulation Accuracy for WLAN 802.11n Standard

This example demonstrates how to configure a default WLAN measurement for a signal according to WLAN 802.11n standard in a remote environment.

```
//----- Preparing the application -----
// Preset the instrument
*RST
// Enter the WLAN option K91n
INSTRUMENT:SELEct WLAN
// Switch to single sweep mode and stop sweep
INITiate:CONTinuous OFF;:ABORt

//----- Configuring the result display -----
// Activate following result displays:
// 1: Magnitude Capture (default, upper left)
// 2: Result Summary Detailed (below Mag Capt)
// 3: Result Summary Global (default, lower right)
// 4: EVM vs Carrier (next to Mag Capt)

LAY:REPL '2',RSD
LAY:ADD:WIND? '1',RIGH,EVC
//Result: '4'

//----- Signal description -----
//Use measurement standard IEEE 802 11n
CONF:STAN 6
//Center frequency is 13.25 GHz
FREQ:CENT 13.25GHZ

//----- Configuring Data Acquisition -----
//Each measurement captures data for 10 ms.
SWE:TIME 10ms
//Set the input sample rate for the captured I/Q data to 20MHz
TRAC:IQ:SRAT 20MHZ
// Number of samples captured per measurement: 0.01s * 20e6 samples per second
// = 200 000 samples
//Include effects from adjacent channels - switch off filter
BAND:FILT OFF
```

```

//----- Synchronization -----
//Improve performance - perform coarse burst search initially
SENS:DEM:TXAR ON
//Minimize the intersymbol interference - FFT start offset determined automatically
SENS:DEM:FFT:OFFS AUTO

//----- Tracking and channel estimation -----
//Improve EVM accuracy - estimate channel from preamble and payload
SENS:DEM:CEST ON
//Use pilot sequence as defined in standard
SENS:TRAC:PIL STAN
//Disable all tracking and compensation functions
SENS:TRAC:LEV OFF
SENS:TRAC:PHAS OFF
SENS:TRAC:TIME OFF

//----- Demodulation -----
//Define a user-defined logical filter to analyze:
SENS:DEM:FORM:BCON:AUTO OFF
//all PPDU formats
SENS:DEM:FORM:BAN:BTYP:AUTO:TYPE ALL
//20MHZ channel bandwidth
SENS:BAND:CHAN:AUTO:TYPE MB20
//an MCS Index '1'
SENS:DEM:FORM:MCS:MODE MEAS
SENS:DEM:FORM:MCS 1
//STBC field = '1'
CONF:WLAN:STBC:AUTO:TYPE M1
//Ness = 1
CONF:WLAN:EXT:AUTO:TYPE M1
//short guard interval length (8 samples)
CONF:WLAN:GTIM:AUTO ON
CONF:WLAN:GTIM:AUTO:TYPE MS

//----- Evaluation range settings -----
//Calculate statistics over 10 PPDUs
SENS:BURS:COUN:STAT ON
SENS:BURS:COUN 10
//Determine payload length from HT signal
CONF:WLAN:PAYL:LENG:SRC HTS
//Payload length: 8-16 symbols
SENS:DEM:FORM:BAN:SYMB:EQU OFF
SENS:DEM:FORM:BAN:SYMB:MIN 8
SENS:DEM:FORM:BAN:SYMB:MAX 16

//----- Measurement settings -----
//Define units for EVM and Gain imbalance results
UNIT:EVM PCT
UNIT:GIMB PCT

```

```

//----- Defining Limits -----
//Define non-standard limits for demonstration purposes
//and return to standard limits later.
//Query current limit settings:
CALC:LIM:BURS:ALL?
//Set new limits:
//Average CF error: 5HZ
//max CF error: 10HZ
//average symbol clock error: 5
//max symbol clock error: 10
//average I/Q offset: 5
//maximum I/Q offset: 10
//average EVM all carriers: 0.1%
//max EVM all carriers: 0.5%
//average EVM data carriers: 0.1%
//max EVM data carriers: 0.5%
//average EVM pilots: 0.1%
//max EVM pilots: 0.5%
CALC:LIM:BURS:ALL 5,10,5,10,5,10,0.1,0.5,0.1,0.5,0.1,0.5

//----- Performing the Measurements -----
// Run 10 (blocking) single measurements
INITiate:IMMediate;*WAI

//----- Retrieving Results -----
//Query the I/Q data from magnitude capture buffer for first ms
// 200 000 samples per second -> 200 samples
TRACel:IQ:DATA:MEMory? 0,200
//Note: result will be too long to display in IECWIN, but is stored in log file
//Query the I/Q data from magnitude capture buffer for second ms
TRACel:IQ:DATA:MEMory? 201,400
//Note: result will be too long to display in IECWIN, but is stored in log file

//Query the current EVM vs carrier trace
TRAC4:DATA? TRACE1
//Note: result will be too long to display in IECWIN, but is stored in log file
//Query the result of the average EVM for all carriers
FETC:BURS:EVM:ALL:AVER?
//Query the result of the EVM limit check for all carriers
CALC:LIM:BURS:ALL:RES?

//Return to standard-defined limits
CALC:LIM:BURS:ALL
//Query the result of the EVM limit check for all carriers again
CALC:LIM:BURS:ALL:RES?

//----- Exporting Captured I/Q Data-----

```

```
//Store the captured I/Q data to a file.
MMEM:STOR:IQ:STAT 1, 'C:\R_S\Instr\user\data.iq.tar'
```

## 9.12.2 Measurement 2: Determining the Spectrum Emission Mask

```
//----- Preparing the application -----
*RST
//Reset the instrument
INST:CRE:NEW WLAN,'SEMMeasurement'
//Activate a WLAN measurement channel named "SEMMeasurement"

//----- Configuring the measurement -----
DISP:TRAC:Y:SCAL:RLEV 0
//Set the reference level to 0 dBm
FREQ:CENT 2.1175 GHz
//Set the center frequency to 2.1175 GHz
CONF:BURS:SPEC:MASK
//Select the spectrum emission mask measurement

//----- Performing the Measurement-----
INIT:CONT OFF
//Stops continuous sweep
SWE:COUN 100
//Sets the number of sweeps to be performed to 100
INIT;*WAI
//Start a new measurement with 100 sweeps and wait for the end

//----- Retrieving Results-----
CALC:LIM:FAIL?
//Queries the result of the limit check
//Result: 0 [passed]
TRAC:DATA? LIST
//Retrieves the peak list of the spectrum emission mask measurement
//Result:
//+1.000000000,-1.275000000E+007,-8.500000000E+006,+1.000000000E+006,+2.108782336E+009,
//-8.057177734E+001,-7.882799530E+001,-2.982799530E+001,+0.000000000,+0.000000000,+0.000000000

//+2.000000000,-8.500000000E+006,-7.500000000E+006,+1.000000000E+006,+2.109000064E+009,
//-8.158547211E+001,-7.984169006E+001,-3.084169006E+001,+0.000000000,+0.000000000,+0.000000000

//+3.000000000,-7.500000000E+006,-3.500000000E+006,+1.000000000E+006,+2.113987200E+009,
//-4.202708435E+001,-4.028330231E+001,-5.270565033,+0.000000000,+0.000000000,+0.000000000,

[...]
```

Table 9-15: Trace results for SEM measurement

Range No.	Start freq. [Hz]	Stop freq. [Hz]	RBW [Hz]	Freq. peak power [Hz]	Abs. peak power [dBm]	Rel. peak power [%]	Delta to margin [dB]	Limit check result	-	-	-
1	+1.00000000	-1.27500000E+007	-8.50000000E+006	+1.00000000E+006	+2.108782336E+009	-8.057177734E+001	-7.882799530E+001	-2.982799530E+001	+0.00000000	+0.00000000	+0.00000000
2	+2.00000000	-8.50000000E+006	-7.50000000E+006	+1.00000000E+006	+2.109000064E+009	-8.158547211E+001	-7.984169006E+001	-3.084169006E+001	+0.00000000	+0.00000000	+0.00000000
3	+3.00000000	-7.50000000E+006	-3.50000000E+006	+1.00000000E+006	+2.113987200E+009	-4.202708435E+001	-4.028330231E+001	-5.270565033	+0.00000000	+0.00000000	+0.00000000
...	...										



## A Annex: Reference

### A.1 Sample Rate and Maximum Usable I/Q Bandwidth for RF Input

For the I/Q data acquisition, digital decimation filters are used internally. The passband of these digital filters determines the *maximum usable I/Q bandwidth*. In consequence, signals within the usable I/Q bandwidth (passband) remain unchanged, while signals outside the usable I/Q bandwidth (passband) are suppressed. Usually, the suppressed signals are noise, artifacts, and the second IF side band. If frequencies of interest to you are also suppressed, you should try to increase the output sample rate, since this increases the maximum usable I/Q bandwidth.



#### Bandwidth extension options

The maximum usable I/Q bandwidth provided by the R&S FSW in the basic installation can be extended by additional options. These options can either be included in the initial installation (B-options) or updated later (U-options). The maximum bandwidth provided by the individual option is indicated by its number, e.g. B80 extends the bandwidth to 80 MHz.

Note that the U-options as of U40 always require all lower-bandwidth options as a prerequisite, while the B-options already include them.

Max. usable I/Q BW	Required B-option	Required U-option(s)
10 MHz	-	-
28 MHz	B28	U28
40 MHz	B40	U28+U40 <b>or</b> B28+U40
80 MHz	B80	U28+U40+U80 <b>or</b> B28+U40+U80 <b>or</b> B40+U80
160 MHz	B160	U28+U40+U80+U160 <b>or</b> B28+U40+U80+U160 <b>or</b> B40+U80+U160 <b>or</b> B80+U160

As a rule, the usable I/Q bandwidth is proportional to the output sample rate. Yet, when the I/Q bandwidth reaches the bandwidth of the analog IF filter (at very high output sample rates), the curve breaks.

## Sample Rate and Maximum Usable I/Q Bandwidth for RF Input

**Relationship between sample rate and usable I/Q bandwidth**

Up to the maximum bandwidth, the following rule applies:

$$\text{Usable I/Q bandwidth} = 0.8 * \text{Output sample rate}$$

The [figure 1-1](#) shows the maximum usable I/Q bandwidths depending on the output sample rates.

**R&S FSW without additional bandwidth extension options**

sample rate: 100 Hz - 10 GHz

maximum I/Q bandwidth: 10 MHz

Sample rate	Maximum I/Q bandwidth
100 Hz to 10 MHz	proportional up to maximum 10 MHz
10 MHz to 10 GHz	10 MHz

**R&S FSW with options B28 or U28 (I/Q Bandwidth Extension):**

sample rate: 100 Hz - 10 GHz

maximum bandwidth: 28 MHz

Sample rate	Maximum I/Q bandwidth
100 Hz to 35 MHz	proportional up to maximum 28 MHz
35 MHz to 10 GHz	28 MHz

**R&S FSW with option B40 or U40 (I/Q Bandwidth Extension):**

sample rate: 100 Hz - 10 GHz

maximum bandwidth: 40 MHz

Sample rate	Maximum I/Q bandwidth
100 Hz to 50 MHz	proportional up to maximum 40 MHz
50 MHz to 10 GHz	40 MHz

**R&S FSW with option B80 or U80 (I/Q Bandwidth Extension):**

sample rate: 100 Hz - 10 GHz

maximum bandwidth: 80 MHz

Sample rate	Maximum I/Q bandwidth
100 Hz to 100 MHz	proportional up to maximum 80 MHz
100 MHz to 10 GHz	80 MHz

**R&S FSW with activated option B160 or U160 (I/Q Bandwidth Extension):**

sample rate: 100 Hz - 10 GHz

maximum bandwidth: 160 MHz

Sample rate	Maximum I/Q bandwidth
100 Hz to 10 GHz	proportional up to maximum 1600 MHz

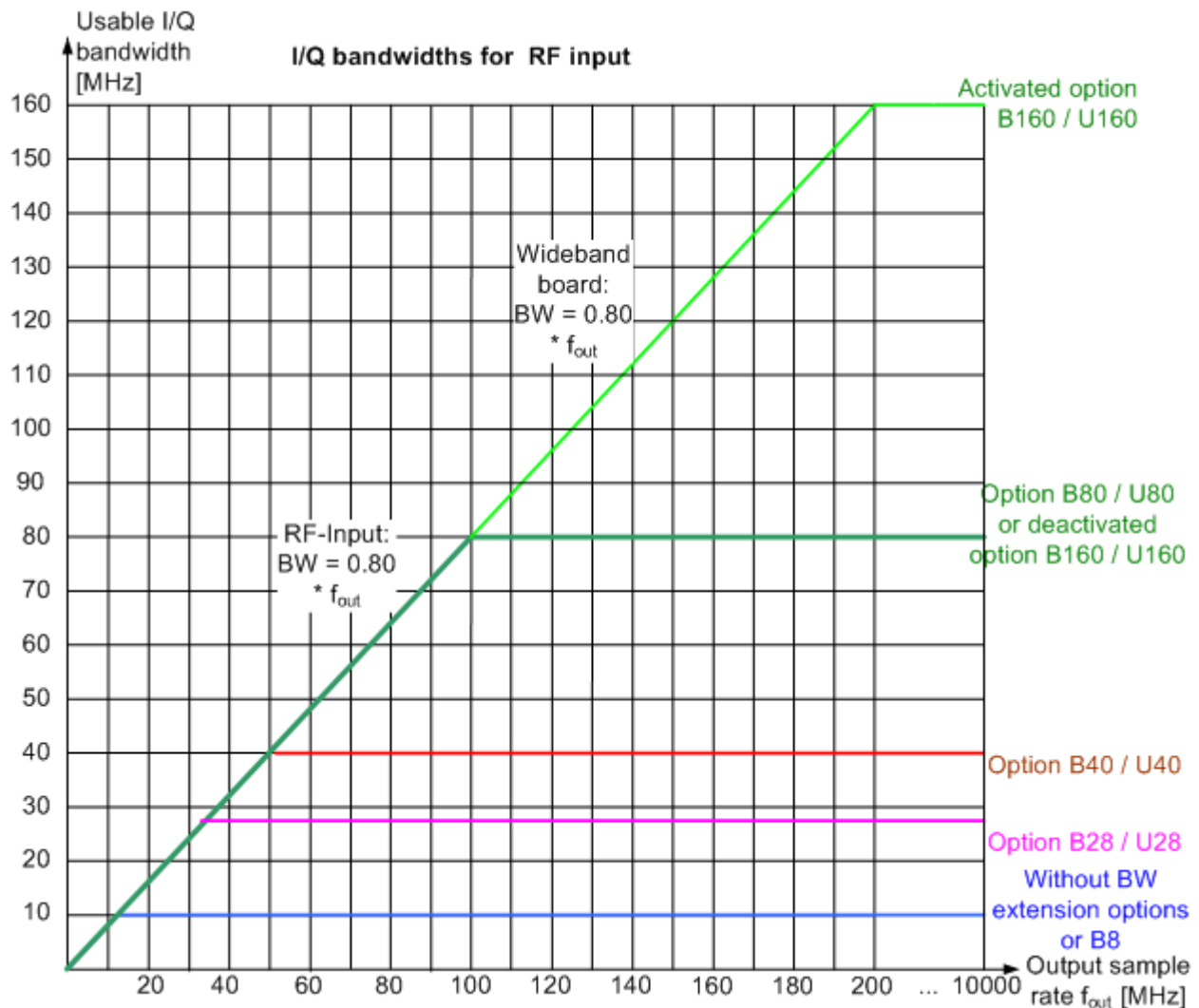

Fig. 1-1: Relationship between maximum usable I/Q bandwidth and output sample rate

## A.2 Reference: I/Q Data File Export Format (iq.tar)

I/Q data is stored in a compressed format with the file extension `.iq.tar`.

An `.iq.tar` file contains I/Q data in binary format together with meta information that describes the nature and the source of data, e.g. the sample rate. The objective of

the `.iq.tar` file format is to separate I/Q data from the meta information while still having both inside one file. In addition, the file format allows you to preview the I/Q data in a web browser, and allows you to include user-specific data.

### Contained files

An `iq-tar` file must contain the following files:

- **I/Q parameter XML file**, e.g. `xyz.xml`  
Contains meta information about the I/Q data (e.g. sample rate). The filename can be defined freely, but there must be only one single I/Q parameter XML file inside an `iq-tar` file.
- **I/Q data binary file**, e.g. `xyz.complex.float32`  
Contains the binary I/Q data of all channels. There must be only one single I/Q data binary file inside an `iq-tar` file.

Optionally, an `iq-tar` file can contain the following file:

- **I/Q preview XSLT file**, e.g. `open_IqTar_xml_file_in_web_browser.xslt`  
Contains a stylesheet to display the I/Q parameter XML file and a preview of the I/Q data in a web browser.

## A.2.1 I/Q Parameter XML File Specification



The content of the I/Q parameter XML file must comply with the XML schema `RsIqTar.xsd` available at: <http://www.rohde-schwarz.com/file/RsIqTar.xsd>.

In particular, the order of the XML elements must be respected, i.e. `iq-tar` uses an "ordered XML schema". For your own implementation of the `iq-tar` file format make sure to validate your XML file against the given schema.

The following example shows an I/Q parameter XML file. The XML elements and attributes are explained in the following sections.

### Sample I/Q parameter XML file: `xyz.xml`

```
<?xml version="1.0" encoding="UTF-8"?>
<?xml-stylesheet type="text/xsl"
href="open_IqTar_xml_file_in_web_browser.xslt"?>
<RS_IQ_TAR_FileFormat fileFormatVersion="1"
xsi:noNamespaceSchemaLocation="RsIqTar.xsd"
xmlns:xsi="http://www.w3.org/2001/XMLSchema-instance">
  <Name>FSV-K10</Name>
  <Comment>Here is a comment</Comment>
  <DateTime>2011-01-24T14:02:49</DateTime>
  <Samples>68751</Samples>
  <Clock unit="Hz">6.5e+006</Clock>
  <Format>complex</Format>
  <DataType>float32</DataType>
  <ScalingFactor unit="V">1</ScalingFactor>
```

## Reference: I/Q Data File Export Format (iq.tar)

```

    <NumberOfChannels>1</NumberOfChannels>
<DataFilename>xyz.complex.float32</DataFilename>
<UserData>
  <UserDefinedElement>Example</UserDefinedElement>
</UserData>
  <PreviewData>...</PreviewData>
</RS_IQ_TAR_FileFormat>

```

Element	Description
RS_IQ_TAR_FileFormat	The root element of the XML file. It must contain the attribute <code>fileFormatVersion</code> that contains the number of the file format definition. Currently, <code>fileFormatVersion</code> "2" is used.
Name	Optional: describes the device or application that created the file.
Comment	Optional: contains text that further describes the contents of the file.
DateTime	Contains the date and time of the creation of the file. Its type is <code>xs:dateTime</code> (see <code>RsIqTar.xsd</code> ).
Samples	Contains the number of samples of the I/Q data. For multi-channel signals all channels have the same number of samples. One sample can be: <ul style="list-style-type: none"> <li>• A complex number represented as a pair of I and Q values</li> <li>• A complex number represented as a pair of magnitude and phase values</li> <li>• A real number represented as a single real value</li> </ul> See also <code>Format</code> element.
Clock	Contains the clock frequency in Hz, i.e. the sample rate of the I/Q data. A signal generator typically outputs the I/Q data at a rate that equals the clock frequency. If the I/Q data was captured with a signal analyzer, the signal analyzer used the clock frequency as the sample rate. The attribute <code>unit</code> must be set to "Hz".
Format	Specifies how the binary data is saved in the I/Q data binary file (see <code>DataFilename</code> element). Every sample must be in the same format. The format can be one of the following: <ul style="list-style-type: none"> <li>• Complex: Complex number in cartesian format, i.e. I and Q values interleaved. I and Q are unitless</li> <li>• Real: Real number (unitless)</li> <li>• Polar: Complex number in polar format, i.e. magnitude (unitless) and phase (rad) values interleaved. Requires <code>DataType = float32</code> or <code>float64</code></li> </ul>
DataType	Specifies the binary format used for samples in the I/Q data binary file (see <code>DataFilename</code> element and <a href="#">chapter A.2.2, "I/Q Data Binary File"</a> , on page 207). The following data types are allowed: <ul style="list-style-type: none"> <li>• <code>int8</code>: 8 bit signed integer data</li> <li>• <code>int16</code>: 16 bit signed integer data</li> <li>• <code>int32</code>: 32 bit signed integer data</li> <li>• <code>float32</code>: 32 bit floating point data (IEEE 754)</li> <li>• <code>float64</code>: 64 bit floating point data (IEEE 754)</li> </ul>
ScalingFactor	Optional: describes how the binary data can be transformed into values in the unit Volt. The binary I/Q data itself has no unit. To get an I/Q sample in the unit Volt the saved samples have to be multiplied by the value of the <code>ScalingFactor</code> . For polar data only the magnitude value has to be multiplied. For multi-channel signals the <code>ScalingFactor</code> must be applied to all channels.  The <code>ScalingFactor</code> must be > 0. If the <code>ScalingFactor</code> element is not defined, a value of 1 V is assumed.

Element	Description
NumberOfChannels	Optional: specifies the number of channels, e.g. of a MIMO signal, contained in the I/Q data binary file. For multi-channels, the I/Q samples of the channels are expected to be interleaved within the I/Q data file (see <a href="#">chapter A.2.2, "I/Q Data Binary File"</a> , on page 207). If the <code>NumberOfChannels</code> element is not defined, one channel is assumed.
DataFilename	Contains the filename of the I/Q data binary file that is part of the <code>iq-tar</code> file. It is recommended that the filename uses the following convention: <xyz>.<Format>.<Channels>ch.<Type> <ul style="list-style-type: none"> <li>• &lt;xyz&gt; = a valid Windows file name</li> <li>• &lt;Format&gt; = complex, polar or real (see <code>Format</code> element)</li> <li>• &lt;Channels&gt; = Number of channels (see <code>NumberOfChannels</code> element)</li> <li>• &lt;Type&gt; = float32, float64, int8, int16, int32 or int64 (see <code>Data Type</code> element)</li> </ul> Examples: <ul style="list-style-type: none"> <li>• xyz.complex.1ch.float32</li> <li>• xyz.polar.1ch.float64</li> <li>• xyz.real.1ch.int16</li> <li>• xyz.complex.16ch.int8</li> </ul>
UserData	Optional: contains user, application or device-specific XML data which is not part of the <code>iq-tar</code> specification. This element can be used to store additional information, e.g. the hardware configuration. It is recommended that you add user data as XML content.
PreviewData	Optional: contains further XML elements that provide a preview of the I/Q data. The preview data is determined by the routine that saves an <code>iq-tar</code> file (e.g. R&S FSW). For the definition of this element refer to the <code>RsIqTar.xsd</code> schema. Note that the preview can be only displayed by current web browsers that have JavaScript enabled and if the XSLT stylesheet <code>open_IqTar_xml_file_in_web_browser.xslt</code> is available.

### Example: ScalingFactor

Data stored as `int16` and a desired full scale voltage of 1 V

$$\text{ScalingFactor} = 1 \text{ V} / \text{maximum int16 value} = 1 \text{ V} / 2^{15} = 3.0517578125e-5 \text{ V}$$

Scaling Factor	Numerical value	Numerical value x ScalingFactor
Minimum (negative) int16 value	$-2^{15} = -32768$	-1 V
Maximum (positive) int16 value	$2^{15}-1 = 32767$	0.999969482421875 V

### Example: PreviewData in XML

```
<PreviewData>
  <ArrayOfChannel length="1">
    <Channel>
      <PowerVsTime>
        <Min>
          <ArrayOfFloat length="256">
            <float>-95</float>
            <float>-94</float>
            ...
            <float>-93</float>
          </ArrayOfFloat>
        </Min>
      </PowerVsTime>
    </Channel>
  </ArrayOfChannel>
</PreviewData>
```

```

    </Min>
    <Max>
      <ArrayOfFloat length="256">
        <float>0</float>
        <float>-41</float>
        ...
        <float>0</float>
      </ArrayOfFloat>
    </Max>
  </PowerVsTime>
</Spectrum>
  <Min>
    <ArrayOfFloat length="256">
      <float>-107</float>
      <float>-96</float>
      ...
      <float>-94</float>
    </ArrayOfFloat>
  </Min>
  <Max>
    <ArrayOfFloat length="256">
      <float>-25</float>
      <float>1</float>
      ...
      <float>1</float>
    </ArrayOfFloat>
  </Max>
</Spectrum>
</Channel>
</ArrayOfChannel>
</PreviewData>

```

## A.2.2 I/Q Data Binary File

The I/Q data is saved in binary format according to the format and data type specified in the XML file (see `Format` element and `Data Type` element). To allow reading and writing of streamed I/Q data all data is interleaved, i.e. complex values are interleaved pairs of I and Q values and multi-channel signals contain interleaved (complex) samples for channel 1, channel 2, channel 3 etc.

### Example: NumberOfChannels - Element ordering for complex cartesian data

Complex data: I[channel no][time index], Q[channel no][time index]

```

I[0][0], Q[0][0],           // Channel 0, Complex sample 0
I[1][0], Q[1][0],           // Channel 1, Complex sample 0
I[2][0], Q[2][0],           // Channel 2, Complex sample 0

I[0][1], Q[0][1],           // Channel 0, Complex sample 1

```

## Reference: I/Q Data File Export Format (iq.tar)

```
I[1][1], Q[1][1],           // Channel 1, Complex sample 1
I[2][1], Q[2][1],           // Channel 2, Complex sample 1

I[0][2], Q[0][2],           // Channel 0, Complex sample 2
I[1][2], Q[1][2],           // Channel 1, Complex sample 2
I[2][2], Q[2][2],           // Channel 2, Complex sample 2

I[0][3], Q[0][3],           // Channel 0, Complex sample 3
I[1][3], Q[1][3],           // Channel 1, Complex sample 3
I[2][3], Q[2][3],           // Channel 2, Complex sample 3

...
```



## List of Remote Commands (WLAN)

ABORt.....	159
CALCulate:LIMit:BURSt:ALL.....	145
CALCulate:LIMit:BURSt:ALL:RESult?.....	170
CALCulate:LIMit:BURSt:EVM:ALL:MAXimum.....	146
CALCulate:LIMit:BURSt:EVM:ALL:MAXimum:RESult?.....	171
CALCulate:LIMit:BURSt:EVM:ALL[:AVERage].....	146
CALCulate:LIMit:BURSt:EVM:ALL[:AVERage]:RESult?.....	171
CALCulate:LIMit:BURSt:EVM:DATA:MAXimum.....	146
CALCulate:LIMit:BURSt:EVM:DATA:MAXimum:RESult?.....	171
CALCulate:LIMit:BURSt:EVM:DATA[:AVERage].....	146
CALCulate:LIMit:BURSt:EVM:DATA[:AVERage]:RESult?.....	171
CALCulate:LIMit:BURSt:EVM:PILot:MAXimum.....	146
CALCulate:LIMit:BURSt:EVM:PILot:MAXimum:RESult?.....	171
CALCulate:LIMit:BURSt:EVM:PILot[:AVERage].....	146
CALCulate:LIMit:BURSt:EVM:PILot[:AVERage]:RESult?.....	171
CALCulate:LIMit:BURSt:FERRor:MAXimum.....	147
CALCulate:LIMit:BURSt:FERRor:MAXimum:RESult?.....	171
CALCulate:LIMit:BURSt:FERRor[:AVERage].....	147
CALCulate:LIMit:BURSt:FERRor[:AVERage]:RESult?.....	171
CALCulate:LIMit:BURSt:IQOFFset:MAXimum.....	147
CALCulate:LIMit:BURSt:IQOFFset:MAXimum:RESult?.....	172
CALCulate:LIMit:BURSt:IQOFFset[:AVERage].....	147
CALCulate:LIMit:BURSt:IQOFFset[:AVERage]:RESult?.....	172
CALCulate:LIMit:BURSt:SYMBolerror:MAXimum.....	147
CALCulate:LIMit:BURSt:SYMBolerror:MAXimum:RESult?.....	172
CALCulate:LIMit:BURSt:SYMBolerror[:AVERage].....	147
CALCulate:LIMit:BURSt:SYMBolerror[:AVERage]:RESult?.....	172
CALCulate<n>:LIMit<k>:ACPoweR:ACHannel:RESult?.....	173
CALCulate<n>:LIMit<k>:ACPoweR:ALternate<ch>:RESult?.....	173
CALCulate<n>:LIMit<k>:FAIL.....	173
CALCulate<n>:MARKer<m>:FUNctioN:POWeR:RESult?.....	174
CALCulate<n>:MARKer<m>:Y?.....	187
CALCulate<n>:MARKer<m>[:STATe].....	187
CALCulate<n>:STATistics:RESult<t>.....	175
CONFigure:BURSt:CONSt:CCARrier[:IMMediate].....	108
CONFigure:BURSt:CONSt:CSYMBOL[:IMMediate].....	109
CONFigure:BURSt:EVM:ECARrier[:IMMediate].....	109
CONFigure:BURSt:EVM:ESYMBOL[:IMMediate].....	109
CONFigure:BURSt:SPEctrum:ACPR[:IMMediate].....	111
CONFigure:BURSt:SPEctrum:FFT[:IMMediate].....	109
CONFigure:BURSt:SPEctrum:FLATness:SElect.....	109
CONFigure:BURSt:SPEctrum:FLATness[:IMMediate].....	110
CONFigure:BURSt:SPEctrum:MASK[:IMMediate].....	111
CONFigure:BURSt:SPEctrum:OBWidth[:IMMediate].....	111
CONFigure:BURSt:STATistics:BSTReam[:IMMediate].....	110

CONFigure:BURSt:STATistics:CCDF[:IMMediate].....	111
CONFigure:BURSt:STATistics:SField[:IMMediate].....	110
CONFigure:STANdard.....	112
CONFigure:WLAN:EXTension:AUTO:TYPE.....	133
CONFigure:WLAN:GTIme:AUTO.....	134
CONFigure:WLAN:GTIme:AUTO:TYPE.....	134
CONFigure:WLAN:GTIme:SElect.....	135
CONFigure:WLAN:PAYLoad:LENGth:SRC.....	142
CONFigure:WLAN:STBC:AUTO:TYPE.....	136
DIAGnostic<n>:SERVice:NSource.....	115
DISPlay:FORMat.....	151
DISPlay[:WINDow<n>]:SElect.....	152
DISPlay[:WINDow<n>]:SIZE.....	151
DISPlay[:WINDow<n>]:TABLe:ITEM.....	158
DISPlay[:WINDow<n>]:TRACe:Y[:SCALe]:RLEVel.....	117
DISPlay[:WINDow<n>]:TRACe:Y[:SCALe]:RLEVel:OFFSet.....	118
DISPlay[:WINDow<n>]:ZOOM:AREA.....	188
DISPlay[:WINDow<n>]:ZOOM:MULTiple<zoom>:AREA.....	189
DISPlay[:WINDow<n>]:ZOOM:MULTiple<zoom>:STATe.....	190
DISPlay[:WINDow<n>]:ZOOM:STATe.....	189
FETCh:BURSt:ALL.....	166
FETCh:BURSt:COUNt:ALL?.....	165
FETCh:BURSt:COUNt?.....	165
FETCh:BURSt:CRESt:MAXimum?.....	167
FETCh:BURSt:CRESt:MINimum?.....	167
FETCh:BURSt:CRESt[:AVERAge]?.....	167
FETCh:BURSt:EVM:ALL:AVERAge?.....	167
FETCh:BURSt:EVM:ALL:MAXimum?.....	167
FETCh:BURSt:EVM:ALL:MINimum?.....	167
FETCh:BURSt:EVM:DATA:AVERAge?.....	167
FETCh:BURSt:EVM:DATA:MAXimum?.....	167
FETCh:BURSt:EVM:DATA:MINimum?.....	167
FETCh:BURSt:EVM:PILot:AVERAge?.....	168
FETCh:BURSt:EVM:PILot:MAXimum?.....	168
FETCh:BURSt:EVM:PILot:MINimum?.....	168
FETCh:BURSt:FERRor:AVERAge?.....	168
FETCh:BURSt:FERRor:MAXimum?.....	168
FETCh:BURSt:FERRor:MINimum?.....	168
FETCh:BURSt:GIMBalance:AVERAge?.....	168
FETCh:BURSt:GIMBalance:MAXimum?.....	168
FETCh:BURSt:GIMBalance:MINimum?.....	168
FETCh:BURSt:IQOffset:AVERAge?.....	168
FETCh:BURSt:IQOffset:MAXimum?.....	168
FETCh:BURSt:IQOffset:MINimum?.....	168
FETCh:BURSt:PAYLoad?.....	168
FETCh:BURSt:PEAK?.....	169
FETCh:BURSt:PREamble?.....	169
FETCh:BURSt:QUADOffset:AVERAge?.....	169

FETCh:BURSt:QUADoffset:MAXimum?	169
FETCh:BURSt:QUADoffset:MINimum?	169
FETCh:BURSt:RMS:MAXimum?	169
FETCh:BURSt:RMS:MINimum?	169
FETCh:BURSt:RMS[:AVERage]?	169
FETCh:BURSt:SYMBolerror:AVERage	169
FETCh:BURSt:SYMBolerror:MAXimum	169
FETCh:BURSt:SYMBolerror:MINimum	169
FETCh:SYMBol:COUNT?	165
FORMat[:DATA]	176
INITiate:CONMeas	160
INITiate:CONTinuous	161
INITiate:SEQuencer:ABORT	162
INITiate:SEQuencer:IMMediate	162
INITiate:SEQuencer:MODE	162
INITiate[:IMMediate]	161
INPut:ATTenuation	118
INPut:ATTenuation:AUTO	118
INPut:ATTenuation:PROTection:RESet	113
INPut:COUPling	113
INPut:EATT	119
INPut:EATT:AUTO	119
INPut:EATT:STATe	119
INPut:FILTer:HPASs[:STATe]	113
INPut:FILTer:YIG[:STATe]	113
INPut:GAIN:STATe	120
INPut:GAIN[:VALue]	120
INPut:IMPedance	114
INPut:SElect	114
INSTRument:CREate:REPLace	105
INSTRument:CREate[:NEW]	104
INSTRument:DELeTe	105
INSTRument:LIST?	105
INSTRument:REName	106
INSTRument[:SElect]	107
LAYout:ADD[:WINDow]?	152
LAYout:CATalog[:WINDow]?	154
LAYout:IDENtify[:WINDow]?	154
LAYout:REMOve[:WINDow]	155
LAYout:REPLace[:WINDow]	155
LAYout:SPLitter	155
LAYout:WINDow<n>:ADD?	157
LAYout:WINDow<n>:IDENtify?	157
LAYout:WINDow<n>:REMOve	157
LAYout:WINDow<n>:REPLace	158
MMEMory:LOAD:IQ:STATe	186
MMEMory:LOAD:SEM:STATe	194
MMEMory:STORE:IQ:STATe	186

OUTPut:TRIGGer<port>:DIRection.....	128
OUTPut:TRIGGer<port>:LEVel.....	128
OUTPut:TRIGGer<port>:OTYPe.....	129
OUTPut:TRIGGer<port>:PULSe:IMMediate.....	129
OUTPut:TRIGGer<port>:PULSe:LENGth.....	130
STATus:OPERation:CONDition?.....	192
STATus:OPERation:ENABle.....	193
STATus:OPERation:NTRansition.....	193
STATus:OPERation:PTRansition.....	194
STATus:OPERation[:EVENT]?.....	192
STATus:PRESet.....	192
STATus:QUEStionable:ACPLimit:CONDition?.....	192
STATus:QUEStionable:ACPLimit:ENABle.....	193
STATus:QUEStionable:ACPLimit:NTRansition.....	193
STATus:QUEStionable:ACPLimit:PTRansition.....	194
STATus:QUEStionable:ACPLimit[:EVENT]?.....	192
STATus:QUEStionable:CONDition?.....	192
STATus:QUEStionable:ENABle.....	193
STATus:QUEStionable:LIMit<n>:CONDition?.....	193
STATus:QUEStionable:LIMit<n>:ENABle.....	193
STATus:QUEStionable:LIMit<n>:NTRansition.....	193
STATus:QUEStionable:LIMit<n>:PTRansition.....	194
STATus:QUEStionable:LIMit<n>[:EVENT]?.....	192
STATus:QUEStionable:NTRansition.....	193
STATus:QUEStionable:PTRansition.....	194
STATus:QUEStionable:SYNC:CONDition?.....	193
STATus:QUEStionable:SYNC:ENABle.....	193
STATus:QUEStionable:SYNC:NTRansition.....	193
STATus:QUEStionable:SYNC:PTRansition.....	194
STATus:QUEStionable:SYNC[:EVENT]?.....	192
STATus:QUEStionable[:EVENT]?.....	192
STATus:QUEue[:NEXT]?.....	192
SYSTem:PRESet:CHANnel[:EXECute].....	107
SYSTem:SEQuencer.....	163
TRACe:IQ:DATA:MEMory.....	178
TRACe:IQ:SRATe.....	122
TRACe<n>[:DATA].....	177
TRACe<n>[:DATA]:X?.....	178
TRIGGer[:SEQuence]:DTIME.....	123
TRIGGer[:SEQuence]:HOLDoff[:TIME].....	123
TRIGGer[:SEQuence]:IFPower:HOLDoff.....	123
TRIGGer[:SEQuence]:IFPower:HYSTeresis.....	124
TRIGGer[:SEQuence]:LEVel:BBPower.....	124
TRIGGer[:SEQuence]:LEVel:IFPower.....	125
TRIGGer[:SEQuence]:LEVel:IQPower.....	125
TRIGGer[:SEQuence]:LEVel:RFPower.....	125
TRIGGer[:SEQuence]:LEVel[:EXTernal<port>].....	124
TRIGGer[:SEQuence]:MODE.....	195

TRIGger[:SEQuence]:SLOPe.....	126
TRIGger[:SEQuence]:SOURce.....	126
TRIGger[:SEQuence]:TIME:RINTerval.....	127
UNIT:EVM.....	169
UNIT:GIMBalance.....	170
[SENSe:]ADJust:CONFigure:DURation.....	148
[SENSe:]ADJust:CONFigure:DURation:MODE.....	148
[SENSe:]ADJust:CONFigure:HYSTeresis:LOWer.....	149
[SENSe:]ADJust:CONFigure:HYSTeresis:UPPer.....	149
[SENSe:]ADJust:LEVel.....	149
[SENSe:]BANDwidth:CHANnel:AUTO:TYPE.....	136
[SENSe:]BANDwidth[:RESolution]:FILTer[:STATe].....	121
[SENSe:]BURSt:COUNT.....	143
[SENSe:]BURSt:COUNT:STATe.....	143
[SENSe:]DEMod:CESTimation.....	131
[SENSe:]DEMod:FFT:OFFSet.....	130
[SENSe:]DEMod:FORMat:BANalyze.....	138
[SENSe:]DEMod:FORMat:BANalyze:BTYPe.....	195
[SENSe:]DEMod:FORMat:BANalyze:BTYPe:AUTO:TYPE.....	138
[SENSe:]DEMod:FORMat:BANalyze:SYMBOLs:EQUal.....	144
[SENSe:]DEMod:FORMat:BANalyze:SYMBOLs:MAX.....	144
[SENSe:]DEMod:FORMat:BANalyze:SYMBOLs:MIN.....	144
[SENSe:]DEMod:FORMat:MCSindex.....	140
[SENSe:]DEMod:FORMat:MCSindex:MODE.....	140
[SENSe:]DEMod:FORMat:NSTSindex.....	141
[SENSe:]DEMod:FORMat:NSTSindex:MODE.....	141
[SENSe:]DEMod:FORMat[:BCONtent]:AUTO.....	139
[SENSe:]DEMod:TXARea.....	130
[SENSe:]FREQuency:CENTer.....	115
[SENSe:]FREQuency:CENTer:STEP.....	116
[SENSe:]FREQuency:CENTer:STEP:AUTO.....	116
[SENSe:]FREQuency:OFFSet.....	117
[SENSe:]SWAPiq.....	121
[SENSe:]SWEep:COUNT.....	150
[SENSe:]SWEep:TIME.....	122
[SENSe:]TRACking:LEVel.....	131
[SENSe:]TRACking:PHASe.....	132
[SENSe:]TRACking:PILots.....	132
[SENSe:]TRACking:TIME.....	132

# Index

## A

Abbreviations	
Signal processing IEEE 802.11a	35
Aborting	
Sweep	87, 88
AC/DC coupling	58
ACLR	
Configuring (cdma2000)	89
Results	29
Activating	
WLAN measurements (remote)	104
Additive white Gaussian noise (AWGN)	37
Adjacent channel leakage ratio	
see ACLR	29
Adjacent channels	
Filtering out	67, 121
Amplitude	
Configuration (remote)	117
Configuration (softkey)	62
Settings	62
Analysis	
Remote control	187
RF measurements	93
Settings	93
Applications	
Adopted parameters	52
Switching	52
Attenuation	64
Auto	64
Default	53
Electronic	64
Manual	64
Option B25	64
Protective	44
Protective (remote)	113
Auto level	
Hysteresis	86
Reference level	64, 86
Softkey	64, 86
Auto settings	85
Meastime Auto (softkey)	86
Meastime Manual (softkey)	86
Remote control	148

## B

Bandwidth	
Extension options	201, 202
Maximum usable	201
Menu	52
Relationship to sample rate	202
Bit error rate (BER)	
Pilot	11
Bitstream	
Result display	17
Trace data	182
Block diagram	
Signal processing IEEE 802.11a	35

## C

Capture buffer	
Results	21
Capture time	11, 66
Default	53
Displayed	9
see also Measurement time	122
Carriers	
Active	42
CCDF	
Configuring (cdma2000)	92
Results	31
Trace data	182
Center frequency	61
Default	53
Error	11
Softkey	61
Step size	62
Channel	
Estimating	75, 131
Estimating (IEEE 802.11a)	41
Channel bandwidth (CBW)	
Default	53
PPDU	77, 78, 136
Channel bar	
Displayed information	9
Channel-defined Sequencer	
Softkey	51
Channel estimation	
Default	53
Remote control	131
Channel power	
ACLR, see ACLR	29
Channels	
Active carriers	42
AWGN (IEEE 802.11a)	37
Display	43
Effective	42
Physical	42
Compensating	
IEEE 802.11a	40
Payload window (IEEE 802.11a)	37
Complementary cumulative distribution function	
see CCDF	31
Constellation	
Result display	17
vs carrier (result display)	18
vs carrier (trace data)	183
vs symbol (trace data)	182
Continue single sweep	
Softkey	88
Continuous Sequencer	
Softkey	51
Continuous sweep	
Softkey	87
Coupling	
Input (remote)	113
Crest Factor	11

**D**

Data acquisition	
see Signal capturing	65
Data format	
Remote	176
Data input	56
Data output	56
Data symbols	
Estimating (IEEE 802.11a)	40
Number	11
Number of; displayed	9
Required	83, 142
Default values	
Preset	53
Demodulation	
Basics	43
Configuring	76
Configuring (remote)	133
Dependencies	44
Parameters	43
Diagram footer	10
Diagrams	
Evaluation method	32
Digital standard	11
Channel bandwidths	78
Default	53
Displayed	9
Selecting	56
Selecting (remote)	112
Display	
Configuration (softkey)	52
Understanding	9
Drop-out time	
Trigger	48, 71

**E**

Electronic input attenuation	64
Errors	
Calculating parameters	39
Calculating parameters (IEEE 802.11a)	41
Center frequency	11
EVM	15
Gain imbalance	11, 13
I/Q offset	11, 13
Messages	97
Phase drift	75, 132
Pilots	75, 132
PPDU levels	75, 131
PPDU timing	75, 132
Quadrature (phase angle I, Q)	14
Quadrature offset	11
Status bits	190
Symbol timing	11
Estimates	
Signal processing (IEEE 802.11a)	36
Estimating	
Channels (IEEE 802.11a)	41
Evaluation methods	
Remote	152
RF	32
Trace data	179
WLAN	16

## Evaluation range

Remote	142
Result displays	82
Settings	93
EVM	
All carriers	11
Calculating (IEEE 802.11a)	41
Calculating (WLAN)	15
Data carriers	11
Data carriers, limit check result (remote)	171
I/Q diagram	16
Limit check result (remote)	170
Limits (remote)	146
Optimizing	75, 131
Pilot carriers	11
Pilot carriers, limit check result (remote)	171
PPDU (direct)	15
Units	169
vs carrier (result display)	19
vs carrier (trace data)	184
vs symbol (result display)	19
Exporting	
Functions	88
I/Q data	56, 88, 203, 207
I/Q data (remote)	186
Softkey	88
Extension Spatial Streams	
PPDUs	81, 133
External trigger	
Level (remote)	124
Softkey	69

**F**

FFT	
AWGN channel (IEEE 802.11a)	37
Carriers	42
Signal processing (IEEE 802.11a)	37
Spectrum (result display)	20
Spectrum (trace data)	184
Start offset	74
Start offset (remote)	130
File format	
I/Q data	203
Files	
I/Q data binary XML	207
I/Q parameter XML	204
Filters	
Adjacent channels	121
High-pass (remote)	113
High-pass (RF input)	58
YIG (remote)	113
Format	
Data (remote)	176
PPDU (remote)	138
Free Run	
Trigger (softkey)	69
Frequency	
Configuration (remote)	115
Configuration (softkey)	61
Deviation	38
Error limit (remote)	147
Frequency offset	62
Default	53
Error, limit check result (remote)	171
Rx-Tx	36

- Frontend
  - Configuration (remote) ..... 115
  - Parameters ..... 46
- G**
- Gain
  - Tracking (IEEE 802.11a) ..... 38
- Gain imbalance ..... 11, 13
  - Units ..... 170
- Group delay
  - Result display ..... 21
  - Trace data ..... 184
- Guard interval ..... 11
  - Displayed ..... 9
  - Length (PPDUs) ..... 81, 134, 135
- H**
- High-pass filter
  - Remote ..... 113
  - RF input ..... 58
- Hysteresis
  - Lower (Auto level) ..... 86
  - Trigger ..... 71
  - Upper (Auto level) ..... 86
- I**
- I/Q data
  - Export file binary data description ..... 207
  - Export file parameter description ..... 204
  - Exporting ..... 56, 88
  - Exporting (remote) ..... 186
  - File format ..... 203
  - Importing ..... 56, 88
  - Importing/Exporting ..... 45
  - Importing (remote) ..... 186
  - Maximum bandwidth ..... 201
  - Sample rate ..... 201
- I/Q measurements
  - Configuring (remote) ..... 111
- I/Q offset ..... 11, 13
  - Limit check result (remote) ..... 172
  - Limits (remote) ..... 147
- I/Q Power
  - Trigger (softkey) ..... 70
  - Trigger level (remote) ..... 125
- IEEE 802.11a
  - Literature ..... 42
  - Modulation formats ..... 43
  - Signal processing ..... 35
- IEEE 802.11n
  - Modulation formats ..... 43
- IF Power
  - Trigger (softkey) ..... 69
  - Trigger level (remote) ..... 125
- Impedance
  - Remote ..... 114
  - Setting ..... 58
- Importing
  - Functions ..... 88
  - I/Q data ..... 56, 88, 204
  - I/Q data (remote) ..... 186
  - Softkey ..... 88
- Input
  - Coupling ..... 58
  - Coupling, default ..... 53
  - Coupling (remote) ..... 113
  - Overload ..... 44
  - Overload (remote) ..... 113
  - RF ..... 58
  - Settings ..... 57, 65
  - Signal, parameters ..... 44
  - Source, Radio frequency (RF) ..... 57
  - Source Configuration (softkey) ..... 57
  - Input sample rate ..... 66
    - Default ..... 53
    - Displayed ..... 9
    - Remote ..... 122
  - Installation ..... 8
  - Inter-channel interference (ICI) ..... 37
- K**
- Keys
  - BW ..... 52
  - LINES ..... 52
  - MKR FUNCT ..... 52
  - RUN CONT ..... 87
  - RUN SINGLE ..... 87, 88
  - SPAN ..... 52
- L**
- Level
  - Tracking ..... 75
  - Tracking (IEEE 802.11a) ..... 38
- Level error tracking ..... 131
- Limits
  - Defining (remote) ..... 145
  - EVM ..... 146
  - EVM, result ..... 170, 171
  - EVM pilot carriers, result ..... 171
  - Frequency error, result ..... 171
  - Frequency error ..... 147
  - I/Q offset ..... 147
  - I/Q offset, result ..... 172
  - Symbol clock error ..... 147
  - Symbol clock error, result ..... 172
- Lines
  - Menu ..... 52
- Literature
  - IEEE 802.11a ..... 42
- Loading
  - Functions ..... 88
- Logical filter ..... 43
- Log likelihood function
  - IEEE 802.11a ..... 39
- Long symbol (LS)
  - IEEE 802.11a ..... 36
- Lower Level Hysteresis
  - Softkey ..... 86
- M**
- Magnitude Capture
  - Result display ..... 21
  - Trace data ..... 179
- Marker Functions
  - Menu ..... 52



- Markers
  - Configuration (remote) ..... 187
  - Querying position (remote) ..... 187
  - Table (evaluation method) ..... 33
- Marker table
  - Evaluation method ..... 33
- Maximizing
  - Windows (remote) ..... 151
- MCS index ..... 11, 79
  - Default ..... 53
  - Displayed ..... 9
  - Displayed information ..... 81
  - Remote ..... 140
- Measurement channel
  - Creating (remote) ..... 104, 105, 107
  - Deleting (remote) ..... 105
  - Querying (remote) ..... 105
  - Renaming (remote) ..... 106
  - Replacing (remote) ..... 105
  - Selecting (remote) ..... 107
- Measurements
  - RF ..... 28
  - RF, results ..... 29
  - RF, types ..... 29
  - Selecting ..... 50, 55
  - Selecting (remote) ..... 107
  - Setup, displayed ..... 9
  - Starting (remote) ..... 159
  - Types ..... 11
- Measurement time
  - Auto settings ..... 86
  - Remote ..... 122
- Messages
  - Signal Field ..... 97
- Modulation
  - Formats ..... 43
  - Inverted (I/Q, remote) ..... 121
  - Inverted (I/Q) ..... 66
  - PPDU ..... 78, 79, 138
  - PPDU (remote) ..... 195
  - PPDUs ..... 79
- Modulation Accuracy
  - Parameters ..... 11
- Modulation and Coding Scheme
  - see MCS ..... 79
- Multiple
  - Measurement channels ..... 50
- N**
- Ness
  - PPDUs ..... 81, 133
- Nof\_symbols ..... 37
- Noise
  - Additive white Gaussian (AWG) ..... 37
  - Source ..... 45, 59
- Nsts
  - PPDUs ..... 79, 80, 141
- Number of samples
  - Displayed ..... 9
- O**
- OBW
  - Configuring (cdma2000) ..... 91
  - Results ..... 30
- Occupied bandwidth
  - see OBW ..... 30
- Offset
  - Amplification I, Q ..... 13
  - Carriers ..... 13
  - Frequency ..... 62
  - Phase angle I, Q ..... 14
  - Quadrature ..... 14
  - Reference level ..... 63
- Options
  - B13 ..... 58, 113
  - B25 ..... 64
  - Bandwidth extension ..... 201, 202
- Output
  - Configuration (remote) ..... 115
  - Configuration (softkey) ..... 59
  - Noise source ..... 45, 59
  - Parameters ..... 44
  - Settings ..... 59
  - Trigger ..... 60, 72
- Overload
  - RF input ..... 44
  - RF input (remote) ..... 113
- Overview
  - Configuring WLAN measurements ..... 54
- P**
- Packet search
  - IEEE 802.11a ..... 36
- Parameters
  - Frontend ..... 46
  - Input signal ..... 44
  - Output ..... 44
  - WLAN ..... 11
- Payload
  - Channel estimation ..... 75, 131
  - Length ..... 83, 142
  - Length (source, remote) ..... 142
  - Length (source) ..... 83
  - Window ..... 37
- Peak list
  - Evaluation method ..... 33
- Phase drift ..... 38
  - Tracking ..... 75
  - Tracking (IEEE 802.11a) ..... 38
- Phase tracking ..... 132
- Pilot bit error rate ..... 11
- Pilots
  - for tracking ..... 75, 132
- Power
  - Interval search ..... 73
  - PPDU ..... 11
  - vs frequency ..... 20
  - vs time, see PvT ..... 22
- Power interval search ..... 130
- Power sensors
  - Trigger mode ..... 70
- PPDU
  - Amount to analyze ..... 83, 143
  - Amount to analyze (remote) ..... 143
  - Analysis mode ..... 77
  - Analyzed ..... 9, 43
  - Channel bandwidth ..... 77, 78, 136
  - Count (remote) ..... 165
  - Currently analyzed ..... 11
  - Demodulation ..... 76

- Displayed ..... 9
- EVM (Direct) ..... 15
- Extension Spatial Streams (IEEE 802.11 n) ..... 81, 133
- Format ..... 77
- Format (default) ..... 53
- Format (remote) ..... 138
- Guard interval length (IEEE 802.11 n, ac) ..... 81, 134, 135
- Level errors ..... 75, 131
- Maximum length (remote) ..... 144
- Minimum length (remote) ..... 144
- Modulation ..... 78, 138
- Modulation (IEEE 802.11 a) ..... 79
- Modulation (IEEE 802.11 n, ac) ..... 79
- Modulation (remote) ..... 195
- Ness (IEEE 802.11 n) ..... 81, 133
- Nsts (IEEE 802.11 ac) ..... 79, 80, 141
- Payload length ..... 83
- Payload length (remote) ..... 142
- Phase drift ..... 75, 132
- Physical channel ..... 11
- Pilots ..... 75, 132
- Power ..... 11
- Power search ..... 73, 130
- Recognized ..... 11, 43
- Signal field ..... 24, 77, 139
- STBC (IEEE 802.11 ac,n) ..... 80, 136
- Timing errors ..... 75, 132
- Total analyzed ..... 11
- Valid ..... 43
- Preamble
  - Channel estimation ..... 75, 131
- Preamplifier
  - Setting ..... 65
  - Softkey ..... 65
- Presetting
  - Channels ..... 55
  - Default values ..... 53
- Pre-trigger ..... 71
- Programming examples
  - SEM ..... 199
  - Statistics ..... 196
  - WLAN ..... 196
- Protection
  - RF input ..... 44
  - RF input (remote) ..... 113
- PvT
  - Full PPDU, result display ..... 22
- PvT Full Burst
  - Trace data ..... 185
- Q**
- Quadrature offset ..... 14
  - Error ..... 11
- R**
- Reference level
  - Auto level ..... 64, 86
  - Default ..... 53
  - Offset ..... 63
  - Offset (softkey) ..... 63
  - Softkey ..... 63
  - Unit ..... 63
  - Value ..... 63
- Remote commands
  - Basics on syntax ..... 100
  - Boolean values ..... 103
  - Capitalization ..... 100
  - Character data ..... 103
  - Data blocks ..... 104
  - Numeric values ..... 102
  - Obsolete ..... 194
  - Optional keywords ..... 101
  - Parameters ..... 102
  - Strings ..... 104
  - Suffixes ..... 101
- Repetition interval ..... 71
  - Softkey ..... 71
- Resetting
  - RF input protection ..... 44, 113
- Restoring
  - Channel settings ..... 55
- Result configuration
  - Softkey ..... 84
- Result displays
  - Bitstream ..... 17
  - Configuration (remote) ..... 150
  - Configuring ..... 52
  - Constellation ..... 17
  - Constellation vs carrier ..... 18
  - Diagram ..... 32
  - Evaluated data ..... 82
  - EVM vs carrier ..... 19
  - EVM vs Symbol ..... 19
  - FFT spectrum ..... 20
  - Group Delay ..... 21
  - Magnitude Capture ..... 21
  - Marker table ..... 33
  - Peak list ..... 33
  - PvT Full PPDU ..... 22
  - Result Summary ..... 33
  - Result Summary, items ..... 84
  - Result Summary, items (remote) ..... 158
  - Result Summary Detailed ..... 22
  - Result Summary Global ..... 24
  - see also Evaluation methods ..... 11
  - Signal Field ..... 24
  - Spectrum Flatness ..... 27
  - WLAN ..... 16
- Results
  - Bitstream ..... 182
  - CCDF ..... 182
  - Constellation vs carrier ..... 183
  - Constellation vs symbol ..... 182
  - Data format (remote) ..... 176
  - Evaluating ..... 93
  - EVM vs Carrier ..... 184
  - FFT Spectrum ..... 184
  - Group delay ..... 184
  - Magnitude Capture ..... 179
  - Numeric (remote) ..... 164
  - PvT Full Burst ..... 185
  - Result summary ..... 179
  - Retrieving (remote) ..... 164
  - RF (remote) ..... 172
  - Signal field ..... 185
  - Spectrum Flatness ..... 185
  - Trace (remote) ..... 176
  - Trace data query (remote) ..... 179

Result Summary		
Detailed (result display)	22	
Evaluation method	33	
Global (result display)	24	
Items to display	84	
Items to display (remote)	158	
Result display	33	
Trace data	179	
Retrieving		
Numeric results (remote)	164	
Results (remote)	164	
RF Results (remote)	172	
Trace results (remote)	176	
RF attenuation		
Auto (softkey)	64	
Manual (softkey)	64	
RF data		
WLAN	28	
RF input	57	
Overload protection	44	
Overload protection (remote)	113	
Remote	112, 114	
RF measurements		
Analysis	93	
Configuration (remote)	150	
Configuring	89	
Performing	95	
Results (remote)	172	
Selecting	89	
RF Power		
Trigger	70	
Trigger level (remote)	125	
RUN CONT		
Key	87	
RUN SINGLE		
Key	87, 88	
<b>S</b>		
Sample rate	11	
Displayed	9	
Maximum	201	
Relationship to bandwidth	202	
Remote	122	
Samples		
Number	11	
Saving		
Functions	88	
Select meas	50	
SEM		
Configuring (cdma2000)	90	
Programming example	199	
Results	29	
Sequencer	50	
Aborting (remote)	162	
Activating (remote)	162	
Mode	51	
Mode (remote)	162	
Remote	161	
Softkey	51	
State	51	
Settings		
Overview	54	
Short symbol (SS)		
IEEE 802.11a	36	
Signal capturing		
Duration	66	
Duration (remote)	122	
Remote control	121	
Softkey	65	
Signal description		
Configuring	56	
Remote control	112	
Softkey	56	
Signal field	139	
Signal Field		
PPDU analysis	77	
Result display	24	
Trace data	185	
Signal processing		
IEEE 802.11a	35	
Signal source		
Remote	114	
Single Sequencer		
Softkey	51	
Single sweep		
Softkey	87	
Slope		
Trigger	72, 126	
SmartGrid	16, 52	
Softkeys		
Amplitude Config	62	
Auto Level	64, 86	
Center	61	
Channel-defined Sequencer	51	
Continue Single Sweep	88	
Continuous Sequencer	51	
Continuous Sweep	87	
Display Config	52	
Export	88	
External	69	
Free Run	69	
Frequency Config	61	
I/Q Power	70	
IF Power	69	
Import	88	
Input Source Config	57	
IQ Export	88	
IQ Import	88	
Lower Level Hysteresis	86	
Meastime Auto	86	
Meastime Manual	86	
Outputs Config	59	
Power Sensor	70	
Preamp	65	
Ref Level	63	
Ref Level Offset	63	
Repetition interval	71	
Result Config	84	
RF Atten Auto	64	
RF Atten Manual	64	
RF Power	70	
Sequencer	51	
Signal Capture	65	
Signal Description	56	
Single Sequencer	51	
Single Sweep	87	
Sweep Config	87	
Sweep count	87	
Time	70	
Trigger Config	67	

- Trigger Offset ..... 71
  - Upper Level Hysteresis ..... 86
  - Space-Time Block Coding
    - see STBC ..... 80
  - Space-time stream ..... 42
  - Span
    - Menu ..... 52
  - Specifics for
    - Configuration ..... 55
  - Spectrum Emission Mask
    - see SEM ..... 29
  - Spectrum Flatness
    - Parameters ..... 11
    - Result display ..... 27
    - Trace data ..... 185
  - Standard
    - see Digital standard ..... 9
  - Standard WLAN measurements ..... 11
  - Starting
    - WLAN application ..... 8
  - Statistic count ..... 83, 143
    - Remote ..... 143
  - Statistics
    - PPDUs ..... 13
    - Programming example ..... 196
  - Status bar ..... 10
    - Error messages ..... 97
  - Status registers
    - Contents ..... 190
    - Querying ..... 190, 191
    - STAT:QUES:POW ..... 113
    - STATus:QUESTIONable:SYNC ..... 190
    - WLAN ..... 190
  - STBC
    - PPDUs ..... 80
    - PPDUs (remote) ..... 136
  - Suffixes
    - Remote commands ..... 101
    - Remote commands (WLAN) ..... 99
  - Swap IQ ..... 66
    - Remote ..... 121
  - Sweep
    - Aborting ..... 87, 88
    - Configuration (remote) ..... 150
    - Configuration (softkey) ..... 87
    - Count ..... 87
    - Time (remote) ..... 122
  - Symbol clock
    - Error ..... 11
    - Error, limit check result (remote) ..... 172
    - error limit (remote) ..... 147
  - Symbols
    - Count (remote) ..... 165
    - Data ..... 40
    - Long (IEEE 802.11a) ..... 36
    - Short (IEEE 802.11a) ..... 36
  - Synchronization ..... 73
    - Remote control ..... 130
- T**
- Time trigger
    - Repetition interval ..... 71
    - Softkey ..... 70
  - Timing
    - Coarse ..... 36
    - Detection (IEEE 802.11a) ..... 36
    - Deviations ..... 21
    - Fine ..... 37
    - Tracking ..... 75
    - Tracking (IEEE 802.11a) ..... 38
  - Timing error tracking ..... 132
  - Tolerance
    - Parameters ..... 11
  - Traces
    - Querying results ..... 16
    - Results (remote) ..... 176
  - Tracking ..... 38
    - Default ..... 53
    - Level errors ..... 75, 131
    - Phase drift ..... 75, 132
    - Pilots ..... 75, 132
    - Remote control ..... 131
    - Timing errors ..... 75, 132
  - Trigger
    - Configuration (remote) ..... 122
    - Configuration (softkey) ..... 67
    - Default ..... 53
    - Drop-out time ..... 71
    - Drop-Out Time ..... 48
    - External (remote) ..... 126
    - Holdoff ..... 49, 72
    - Hysteresis ..... 48, 71
    - Level ..... 71
    - Measurements ..... 47
    - Offset ..... 48
    - Offset (softkey) ..... 71
    - Output ..... 60, 72
    - Slope ..... 72, 126
  - Trigger level
    - External trigger (remote) ..... 124
    - I/Q Power (remote) ..... 125
    - IF Power (remote) ..... 125
    - RF Power (remote) ..... 125
  - Trigger source ..... 69
    - External ..... 69
    - Free Run ..... 69
    - I/Q Power ..... 70
    - IF Power ..... 69
    - Power Sensor ..... 70
    - RF Power ..... 70
    - Time ..... 70
  - Troubleshooting ..... 96
    - Input overload ..... 113
- U**
- Units
    - EVM results ..... 169
    - Gain imbalance results ..... 170
    - Reference level ..... 63
  - Upper Level Hysteresis
    - Softkey ..... 86
  - User manuals ..... 6
- W**
- Windows
    - Adding (remote) ..... 152
    - Closing (remote) ..... 155
    - Configuring ..... 55
    - Layout (remote) ..... 155
    - Maximizing (remote) ..... 151
    - Querying (remote) ..... 154

Replacing (remote) .....	155
Splitting (remote) .....	151
Types (remote) .....	152
Window title bar .....	10
WLAN	
Measurements .....	11
Parameters .....	11
Programming examples .....	196
Remote control .....	99
Results .....	11
<b>Y</b>	
YIG-preselector	
Activating/Deactivating .....	58
Activating/Deactivating (remote) .....	113
Default .....	53
<b>Z</b>	
Zooming	
Activating (remote) .....	189
Area (Multiple mode, remote) .....	189
Area (remote) .....	188
Multiple mode (remote) .....	189, 190
Remote .....	188
Single mode (remote) .....	188